

ON OFF

SMART ITALIAN PROJECTS

TUMIDEI[®]
ATLGROUP[®]

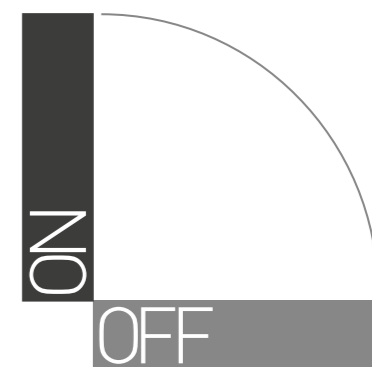

TUMIDEI[®]
ATLGROUP[®]

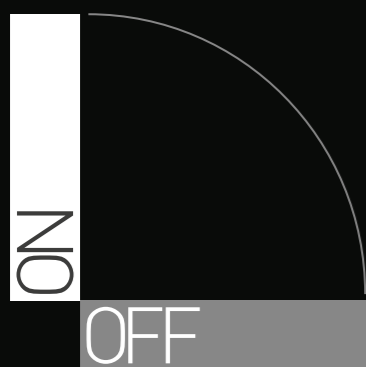

05	<u>ON OFF SYSTEM</u>
11	<u>ALCOVA SYSTEM</u>
	<u>HOME</u>
23	SMART HOME
67	COMFORT HOME
105	HOME OFFICE
	<u>CONTRACT</u>
145	HOTELS
173	RESIDENZIALE
190	<u>TECHNICAL DATA</u>
225	<u>FOCUS</u>
265	<u>FINISHES</u>

TRANSFORMATION

CHANGE

MOTION

SWITCH

FUNCTION

INTERACTION

PROJECT

DESIGN

PLACEMENT

INNOVATION

STYLE

FEELING

ON-OFF SYSTEM

Design Tumidei Lab

Insieme, e in totale libertà. ON-OFF rappresenta un insieme di competenze Made in Italy che collaborano - da un lato - per disegnare un progetto organico e completo, dall'altro per offrire anche un solo prodotto nell'arredare ambienti giorno/notte trasformabili. Veri e propri sistemi che offrono soluzioni definitive per qualità e design e al tempo stesso modificano lo spazio da giorno a notte secondo esigenze individuali e mai come soluzioni di ripiego. La casa diviene così realmente fruibile dai nuclei più compositi: grandi famiglie, giovani coppie, amici che ospitano amici, con la possibilità di ottimizzare spazi piccoli in situazioni stabili di polifunzionalità; una sola stanza diventerà un vero living o una vera camera da letto a seconda delle esigenze. A questo punto non resta altro che immaginare la propria casa, dove, per spazi grandi e piccoli, potrete trovare qui le risposte, il design di qualità e l'esperienza di Tumidei e ATL Group: insieme, ma in totale libertà.

Together and in complete freedom. ON-OFF is the expression of the merging of Made in Italy craftsmanship that cooperates, on one hand, to carry out a whole and systematic project; on the other hand, to offer even just one single product to furnish convertible living/sleeping areas. A true all-encompassing concept that offers permanent solutions in terms of quality and design, and that, at the same time, turns a living into a sleeping area, focusing on actual individual needs and never on a makeshift solution. Thus, everybody can enjoy their home: big families, young couples, friends hosting friends, with the possibility of optimizing small spaces, turning them into enduring multifunctional solutions; the same room will become a true living or a true bedroom, based on needs! So there is nothing left to do but imagine your own home. For both big and small spaces, you will find your answer here: the quality design and experience of TUMIDEI and ATL GROUP: together, but in complete freedom.



B L O C K
ON

DINING WORKING LIVING

6 ON OFF



279 ON OFF SOLUTION

7 ON OFF



B L O C K
OFF

DREAMING SLEEPING RELAX

8 ON OFF



279 ON OFF SOLUTION

9 ON OFF

TRANSFORMATION

CHANGE

MOTION

SWITCH

FUNCTION

INTERACTION

PROJECT

DESIGN

PLACEMENT

INNOVATION

STYLE

FEELING

ALCOVA SYSTEM

Design **Simone Cagnazzo**

*al-cò-va/
sostantivo femminile*

*al-cò-ve/
female substantive*

1.

1.

Parte della camera da letto costituita da una rientranza in una delle pareti, nella quale, talora separato dal resto dell'ambiente con tendaggi o balastrate, si trova il letto: tenera di parto, ella se ne stava in una bella alcova... (Algarotti).

Part of the bedroom, consisting of a recess in one of the walls, in which, sometimes separated from the rest of the room by curtains or balustrade, is the bed.

"Nel Rinascimento e nei secoli successivi fu spesso un ambiente riccamente decorato che poteva contenere, oltre al letto, anche altri mobili soprattutto quando, nel sec. 18°, si diffuse la moda di ricevervi la visita degli intimi; nell'età moderna l'uso dell'alcova, anche nelle sue forme più semplici, è quasi totalmente scomparso"

"In the Renaissance and in the following centuries it was often a richly decorated environment that could contain, besides the bed, other furniture, especially when, in the 18th century, the fashion spread to receive the visit of the intimates; in the modern age the use of the alcove, even in its simplest forms, has almost totally disappeared".

Alcova System è un progetto di infinita grazia: indica, a monte, la discrezione del separare, del proteggere l'intimità più delicata attraverso la cornice di elementi architettonici e di arredo, gentili diaframmi, plutei sottili e sensibili. L'estensione, un passo fuori dall'idillio più segreto, rende alcova la nicchia in cui è custodita la preziosa statuetta d'avorio, la doccia in cui con l'acqua bollente che ci scorre addosso si sta nel mistero del pensiero nostro più riposto, la bocca dei fiori in cui si agitano le api in primavera, il divano morbido su cui stare abbracciati sotto un'usata coperta guardando un film e l'abbraccio stesso. Alcova System ripercorre la sottile linea che divide il giorno dalla notte, la cosiddetta Ora Blu, in un'unica soluzione di arredo, è possibile trasformare la stanza da nicchia contenente una seduta o una panca d'appoggio ideale per spazi ridotti o per creare un piccolo divano dove lo spazio non c'era, per poi trasformarsi in letto comodo e confortevole.

Alcova System is a project of infinite grace: it indicates, upstream, the discretion of separating, of protecting the most delicate intimacy through the frame of architectural and furnishing elements, gentle diaphragms, subtle and sensitive plutei. The extension, a step away from the most secret idyll, makes the alcove the niche where the precious ivory statuette is kept, the shower in which with the boiling water that flows on us lies in the mystery of our most hidden thought, the mouth of the flowers in which the bees are stirring in the spring, the soft sofa on which to be hugged under a blanket, watching a film and the embrace itself. Alcova System traces the thin line that divides the day from the night, the so-called Ora Blu, in a single furnishing solution, it is possible to transform the niche room containing a seat or a support bench ideal for small spaces or to create a small sofa where space was not there, and then turned into a comfy and comfortable bed.



ALCOVA
ON

DINING WORKING LIVING

12 ON OFF



280 ON OFF SOLUTION

13 ON OFF



A L C O V A
OFF

DREAMING SLEEPING RELAX

14 ON OFF



280 ON OFF SOLUTION

15 ON OFF

ON-OFF
HOME

SMART HOME | COMFORT HOME | HOME OFFICE



16 ON OFF

ON-OFF
CONTRACT

HOTEL | RESIDENTIAL

17 ON OFF

ON-OFF STYLE

Scegli l'ambiente che più ti somiglia. Cittadini del mondo, curiosi e avventurosi, romantici o eccentrici ma con una sola volontà: vivere seguendo uno stile che non ha confini. Riduttivo definirla abitazione, piuttosto un nido caldo ed avvolgente il vostro, che rispecchia fedelmente questa filosofia di vita. Lo spirito cosmopolita traspare dalle mura domestiche attraverso forme e colori che evocano atmosfere di terre lontane o di ricordi rassicuranti trasferendo ciò che tu sei nello stile che più ti rappresenta.

Choose the environment that resembles you the most. World-class citizens, curious, adventurous, romantic, eccentric, but with one scope: to live following a style with no boundaries. It is diminishing to define your home a house: it is more of a cozy nest, that fully reflects your living concept. The cosmopolitan spirit clearly stems out of the domestic walls, through shapes and colors that evoke farther reaches or comforting memories that talk about you and your lifestyle.



MINIMAL



ELEGANT



URBAN



ON-OFF
HOME

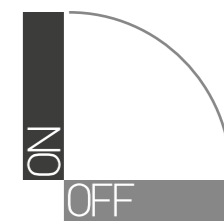

SMART HOME

250
ON OFF
SOLUTION



BLOCK System
FLIP Sofa
GLASS WALL BOX with led

250
ON OFF
SOLUTION



BLOCK System
FLIP Sofa
GLASS WALL BOX with led



L / W 250 cm H 70 cm P / D 82 cm seduta / seat H 48 cm



FLIP SOFA

Design **Simone Cagnazzo**

FLIP è una collezione di divani rigorosi, ispirati a un design puro.

Il sistema d'imbottiti **FLIP** rivoluziona il concetto di divano che diventa modulare e dimezzabile nella sua altezza totale.

Gli schienali del divano e i cuscini delle sedute sono completamente abbattibili, e tutta la struttura superiore reclinabile, in questo modo il divano può essere posto frontalmente al **BLOCK SYSTEM** e **ALCOVA LIGHT**.

FLIP is a collection of austere sofas, inspired by pure design. The **FLIP** system of upholstered elements transforms the concept of sofa which becomes modular and splittable along its total height. The backs of the sofa and the seat cushions are completely flippable and all the upper structure is reclining. In this way, the sofa can be placed in front of the **BLOCK SYSTEM** and **ALCOVA LIGHT**.

ON

L / W 169 cm
H 70 cm
H seduta 48 cm
P / D 82 cm

OFF

H 30 cm
P / D 165 cm





251

ON OFF
SOLUTION

251
ON OFF
SOLUTION



BLOCK System
ON-OFF Sofa
PILL Pouf

#LET'S RELAX



#LET'S SLEEP



ALCOVA LIGHT
SYSTEM 20
FLUFFY Sofa
TWIST Table
PILL Pouf
LINEUP Shelf

252
ON OFF
SOLUTION



ALCOVA LIGHT
SYSTEM 20
FLUFFY Sofa
TWIST Table
PILL Pouf
LINEUP Shelf



FLUFFY SOFA

Design Simone Cagnazzo

Solare e morbida presenza per FLUFFY. Il perfetto incontro tra il comfort e colore, FLUFFY è un sistema di divani flessibili studiati per il totale relax. Disponibili in due differenti larghezze, si contraddistinguono per il particolare meccanismo interno che li rende completamente reclinabili, trasformandoli in sacchi/pouf morbidi e confortevoli. Il FLUFFY è caratterizzato dal dettaglio della maniglia in pelle, che permette una facile presa per reclinare lo schienale. Le versioni sono sfoderabili e le diverse fodere sono tra loro intercambiabili.

Sunny and soft presence for FLUFFY. The perfect match between comfort and color, FLUFFY is a flexible sofas system designed for the total relax. Available in two different sizes, they are characterized by a special internal mechanism which makes them completely reclining and turns them into soft and comfortable poufs. One of the main features of FLUFFY is the leather handle, which enables an easy grip to recline the back. The versions are unlining and the different covers are interchangeable.

ON

L / W 80-115 cm
H 60 cm
P / D 105 cm

OFF

L / W 80-115 cm
H 30 cm
P / D 120 cm



BLOCK System
SYSTEM 20
CODE Handle
FLIP Sofa
LUDO System



253
ON OFF
SOLUTION

BLOCK System
SYSTEM 20
CODE Handle
FLIP Sofa
LUDO System





ALCOVA LIGHT
SYSTEM 20
FLUFFY Sofa
MAGIC Mirror
SLIP



ALCOVA LIGHT
SYSTEM 20
FLUFFY Sofa
MAGIC Mirror
SLIP



254
ON OFF
SOLUTION



ALCOVA System
SYSTEM 20
TWICE System
LINEUP Shelf
PILL Pouf

255
ON OFF
SOLUTION



ALCOVA System
SYSTEM 20
TWICE System
LINEUP Shelf
PILL Pouf



ALCOVA System
SYSTEM 20
TWICE System
LINEUP Shelf
PILL Pouf

255
ON OFF
SOLUTION





TWICE SYSTEM

Design Simone Cagnazzo

Il concetto di TWICE permette la creazione di contenitori unici, free-standing, o ancorati a parete, con elementi pensili o a terra.

Attraverso lo scorrimento del piano superiore a ponte, si crea un piano scrittoio che, sdoppiandosi a libro, si trasforma a sua volta in un pratico e originale tavolo da pranzo.

Il sistema TWICE può essere personalizzato dando la possibilità di avere pezzi decorativi in tonalità oppure in contrasto, permettendo di creare un mobile che è grafico o discreto, secondo le situazioni.

The TWICE concept leads the creation of unique, free-standing or hanging boxes. The sliding of the upper top creates a desk which, once opened like a book, can be converted into a practical and original dining table. The TWICE system can be customized by having decorative items, matching tones or in contrast, in order to create a piece of furniture which can be graphic or sober, depending on the situations.



ON

L / W 186 cm
H 78,8 cm
P / D 45,7 cm

OFF

L / W 186 cm
H 76 cm
P / D 91,5 cm



BLOCK System
SYSTEM 28
ON-OFF Sofa
ON-OFF Club Chair



256
ON OFF
SOLUTION

BLOCK System
SYSTEM 28
ON-OFF Sofa
ON-OFF Club Chair

BLOCK System
SYSTEM 28
SYSTEM 32
ON-OFF Sofa
ON-OFF large armrest with lift-up tablet

257
ON OFF
SOLUTION

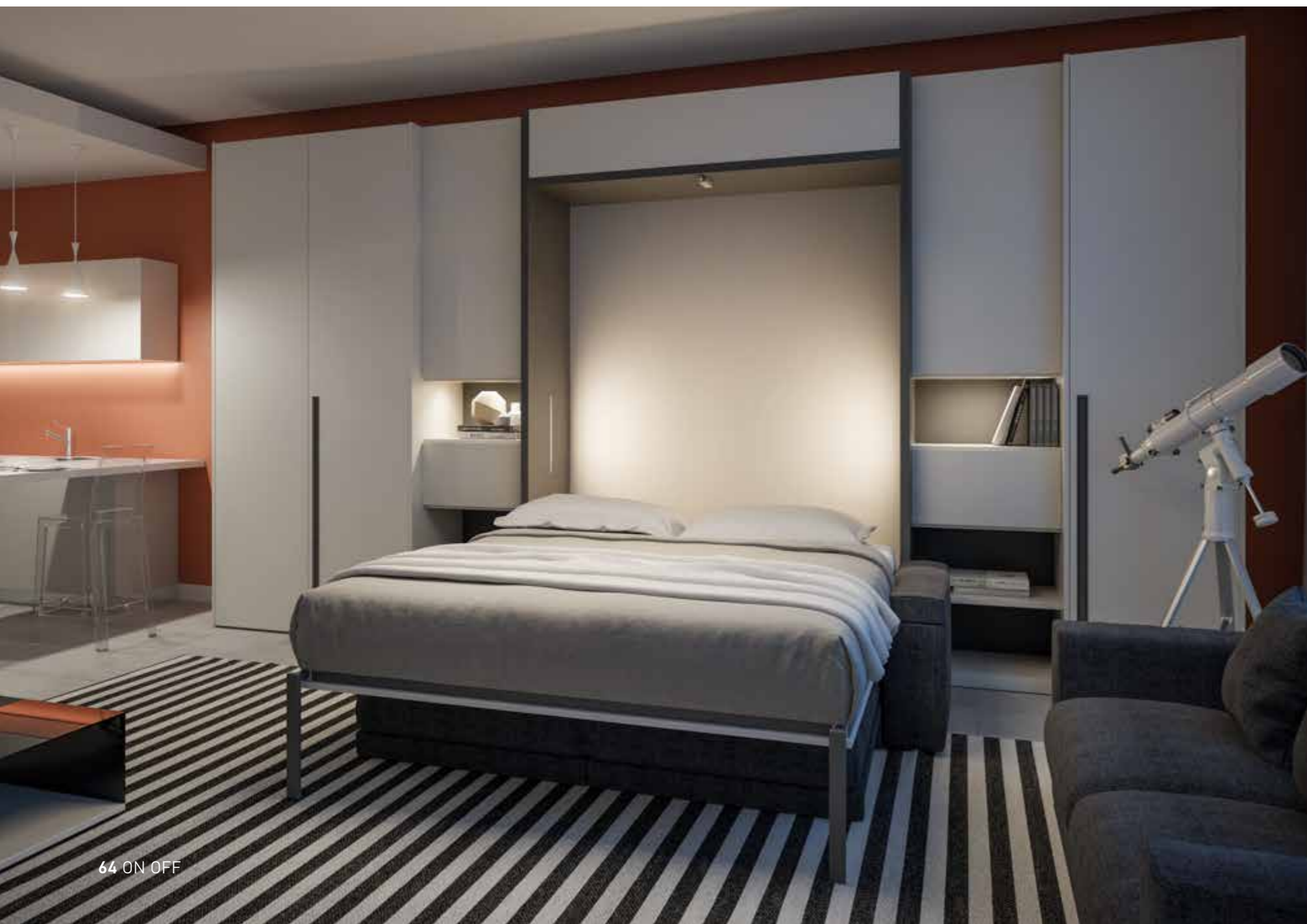

BLOCK System
SYSTEM 28
SYSTEM 32
ON-OFF Sofa
ON-OFF large armrest with lift-up tablet

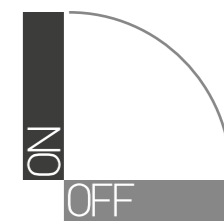

COMFORT HOME



BLOCK System
SYSTEM 28
ON-OFF Sofa
PILL Pouf
SOUND Armrest

258

ON OFF
SOLUTION



BLOCK System
SYSTEM 28
ON-OFF Sofa
PILL Pouf
SOUND Armrest

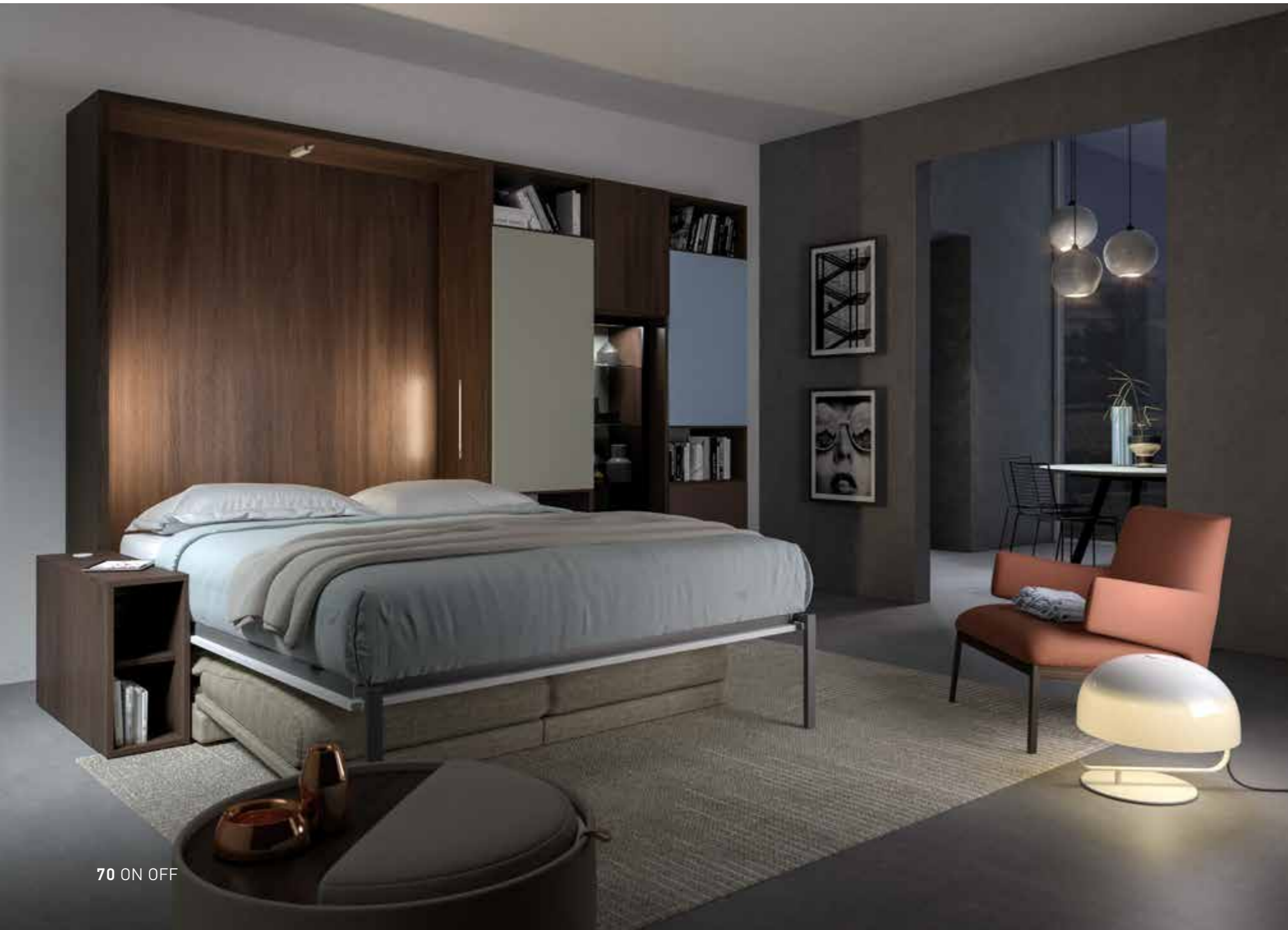

#LET'S DINNER

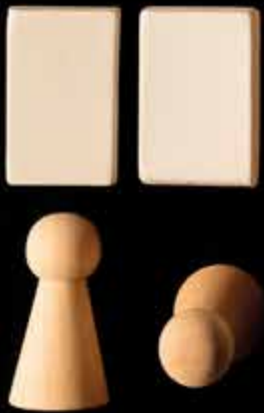
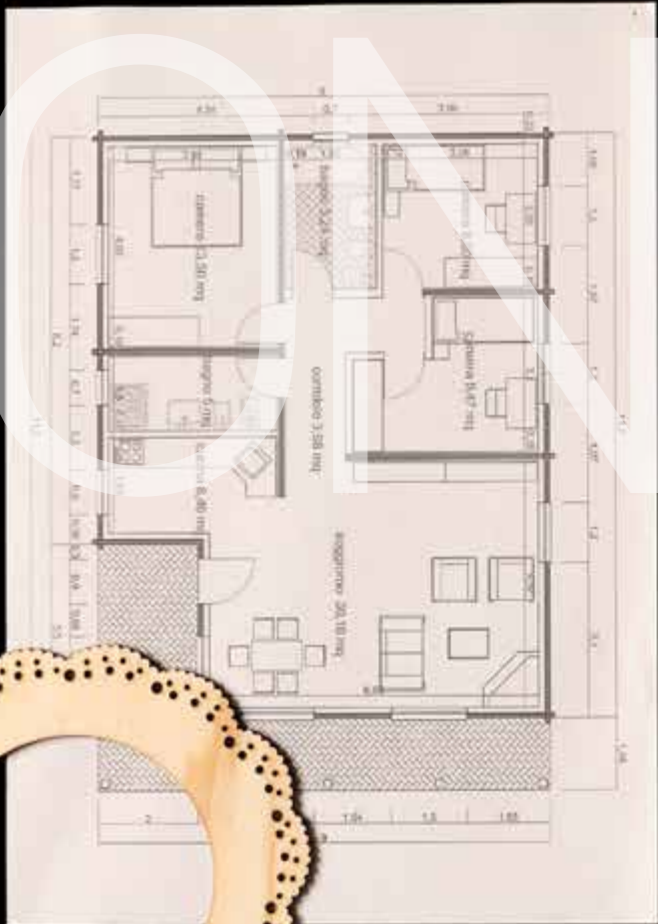

OFF

#LET'S SLEEP



ALCOVA System
SYSTEM 20
PILL Pouf
ABLE Armchair



ALCOVA System
SYSTEM 20
PILL Pouf
ABLE Armchair



259
ON OFF
SOLUTION

TWICE System
PILL Pouf
ABLE Armchair





TWICE SYSTEM

Design Simone Cagnazzo

Il concetto di TWICE permette la creazione di contenitori unici, free-standing, o ancorati a parete, con elementi pensili o a terra.

Attraverso lo scorrimento del piano superiore a ponte, si crea un piano scrittoio che, sdoppiandosi a libro, si trasforma a sua volta in un pratico e originale tavolo da pranzo.

Il sistema TWICE può essere personalizzato dando la possibilità di avere pezzi decorativi in tonalità oppure in contrasto, permettendo di creare un mobile che è grafico o discreto, secondo le situazioni.

The TWICE concept leads the creation of unique, free-standing or hanging boxes. The sliding of the upper top creates a desk which, once opened like a book, can be converted into a practical and original dining table. The TWICE system can be customized by having decorative items, matching tones or in contrast, in order to create a piece of furniture which can be graphic or sober, depending on the situations.



ON

L / W 186 cm
H 78,8 cm
P / D 45,7 cm

OFF

L / W 186 cm
H 76 cm
P / D 91,5 cm



260
ON OFF
SOLUTION

BLOCK System
SYSTEM 32
ON-OFF Sofa



260

ON OFF
SOLUTION



BLOCK System
SYSTEM 32
ON-OFF Sofa

261
ON OFF
SOLUTION

ALCOVA LIGHT
SYSTEM 20
CODE Handle
FLIP Sofa
PILL Pouf

261
ON OFF
SOLUTION

ALCOVA LIGHT
SYSTEM 20
CODE Handle
FLIP Sofa
PILL Pouf



BLOCK System
SYSTEM 28
ON-OFF Sofa



BLOCK System
SYSTEM 28
ON-OFF Sofa

#LET'S MEET

ON

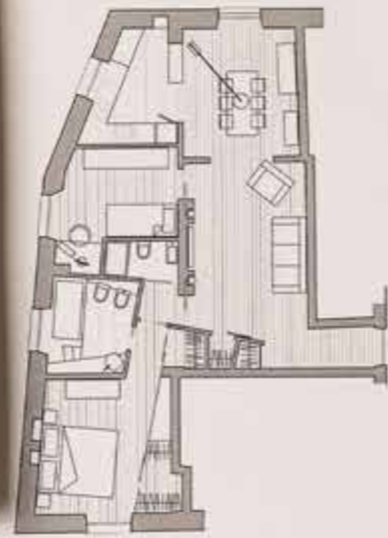

Firefly - Etiopia

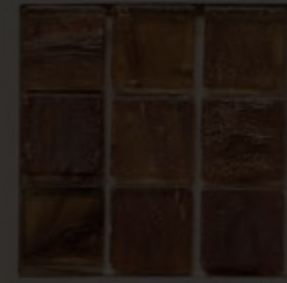

Firefly - Malawi



Firefly - Galles



OFF

#LET'S DREAM

ALCOVA System
SYSTEM 20
anta vetro retrolaccato
back lacquered door

263
ON OFF
SOLUTION



ALCOVA System
SYSTEM 20
anta vetro retrolaccato
back lacquered door

264
ON OFF
SOLUTION



BLOCK System
SYSTEM 28
ON-OFF Sofa

264
ON OFF
SOLUTION



BLOCK System
SYSTEM 28
ON-OFF Sofa

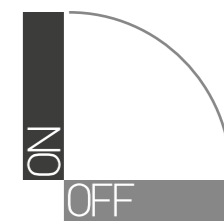

HOME OFFICE

265
ON OFF
SOLUTION



106 ON OFF

BLOCK System
SYSTEM 32
SIDE Handle

107 ON OFF

265
ON OFF
SOLUTION



BLOCK System
SYSTEM 32
SIDE Handle

266
ON OFF
SOLUTION



BLOCK System
SYSTEM 28
LINEUP Shelf
ON-OFF Sofa
PILL Pouf



266

ON OFF
SOLUTION

BLOCK System
SYSTEM 28
LINEUP Shelf
ON-OFF Sofa
PILL Pouf



#LET'S DINNER

ON



OFF

#LET'S SLEEP

BLOCK System
SYSTEM 20
SYSTEM 28
FLUFFY Sofa
PILL Pouf
CODE Handle

267

ON OFF
SOLUTION



BLOCK System
SYSTEM 20
SYSTEM 28
FLUFFY Sofa
PILL Pouf
CODE Handle



118 ON OFF



119 ON OFF



PILL POUF

Design Simone Cagnazzo

PILL è un complemento decisamente moderno, originale e soprattutto versatile poiché può prestarsi contemporaneamente a diversi usi: sollevando la seduta sulla parte superiore del pouf, si accede ad un vano dove riporre i propri oggetti personali, girando e riposizionando la seduta, diventa un pratico coffee-table. Un solo oggetto può fungere da seduta e da tavolino con uno scrigno nascosto. PILL è un pouf che arreda la casa e gli spazi contract con una fresca energia.

PILL is a modern, original and, especially, versatile accessory since, at the same time, it is suitable for different uses: under the pouf seat, there is a place to put the personal items into and, by flipping and replacing the seat, the pouf turns into a practical coffee-table. A single item works as a seat and as a coffee-table with a secret trunk. PILL is a pouf which decorates your home and contract locations too with a fresh energy.



ON OFF

PILL small
L / W 45 cm
H 47 cm
P / D 45 cm

PILL medium
L / W 75 cm
H 35 cm
P / D 75 cm

PILL large
L / W 99 cm
H 35 cm
P / D 99 cm







268
ON OFF
SOLUTION

ALCOVA System
SYSTEM 28
LINEUP Shelf
FRAME Foot with castors
ABLE Armchair

ABLE ARMCHAIR

Design Simone Cagnazzo

Una visione essenziale dell'oggetto poltroncina. L'idea prende forma dalla possibilità di trasformare un elemento essenziale come la poltroncina adatta alla casa e agli spazi contract, rendendola unica nel suo genere. La poltroncina si può ribaltare trasformandosi in piano d'appoggio o in comoda panca centro stanza per due o tre ospiti. Ne scaturisce un pezzo di design moderno e senza tempo, elegante e tecnico, di forte impatto visivo. ABLE è inoltre dotata di un ottomano imbottito con piano trasformabile in coffee-table.

An essential vision of the armchair. The idea takes form from the chance to convert a basic piece of furniture such as the armchair, suitable to houses and contract locations too, making it absolutely one-of-a-kind. The armchair can be overturned, becoming a flat surface or a practical bench for two or three guests. The result is a design product, modern and timeless, elegant and technical, with a strong visual impact. Moreover, ABLE is supplied with an upholstered ottoman with convertible top into a coffee table.

ON

ABLE Poltrona

L / W 66cm
H 63 cm
P / D 66 cm

ABLE Pouf

L / W 52 cm
H 28 cm
P / D 58 cm

OFF

ABLE Poltrona

L / W 66cm
H 31,5 cm
P / D 132 cm



#LET'S RELAX

ON

OFF

#LET'S SLEEP



BLOCK System
ON-OFF Sofa
T-BOX Shelf



269
ON OFF
SOLUTION

BLOCK System
ON-OFF Sofa
T-BOX Shelf



270
ON OFF
SOLUTION

BLOCK System
SYSTEM 28
ON-OFF Sofa

270
ON OFF
SOLUTION

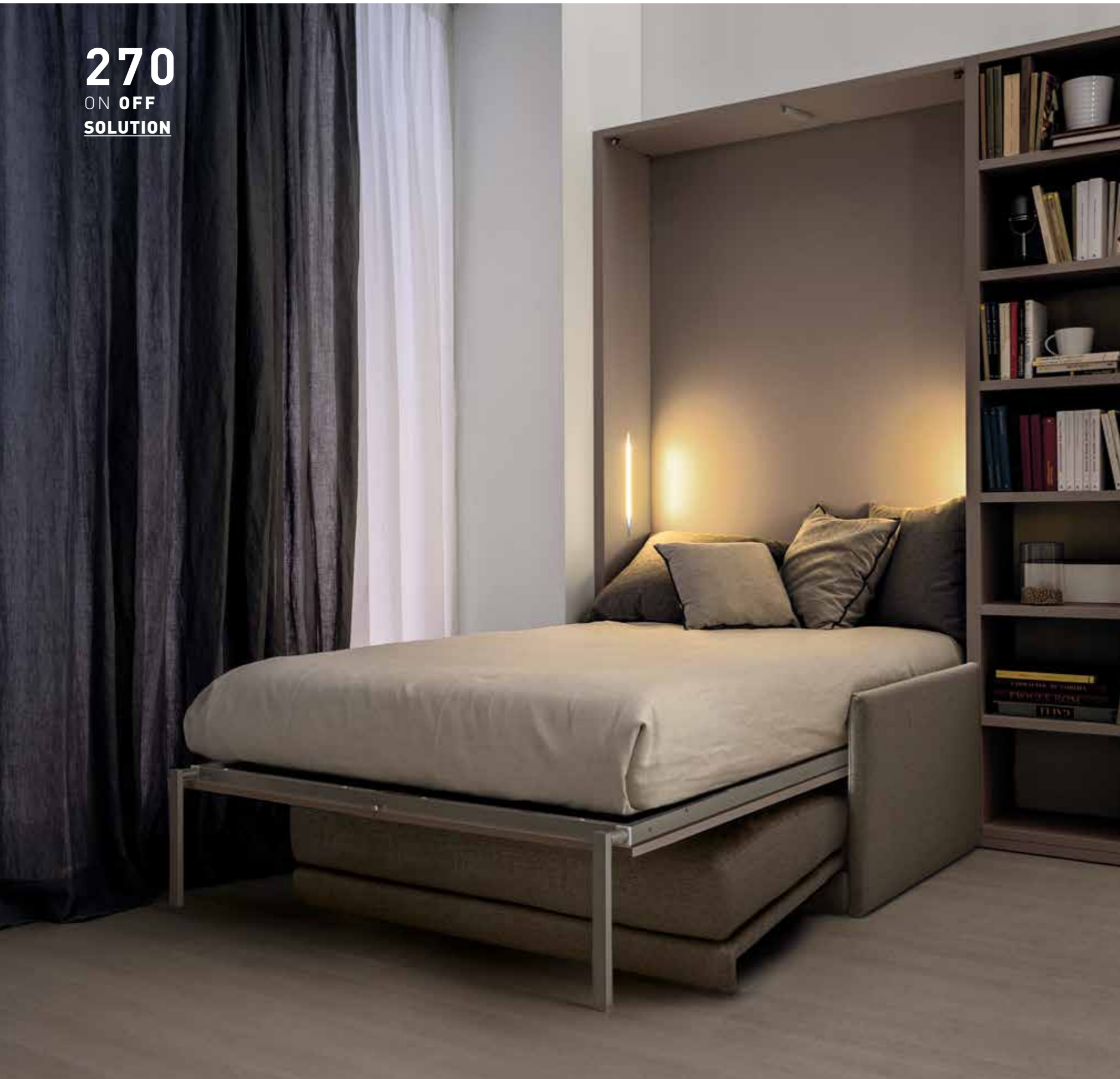

BLOCK System
SYSTEM 28
ON-OFF Sofa



BLOCK System
SYSTEM 28
ON-OFF Sofa



BLOCK System
SYSTEM 28
ON-OFF Sofa

271
ON OFF
SOLUTION



2502

ON-OFF
CONTRACT

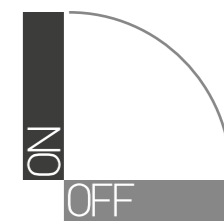

HOTELS



272
ON OFF
SOLUTION

272
ON OFF
SOLUTION



BLOCK System
ON-OFF Sofa

#LET'S DINNER

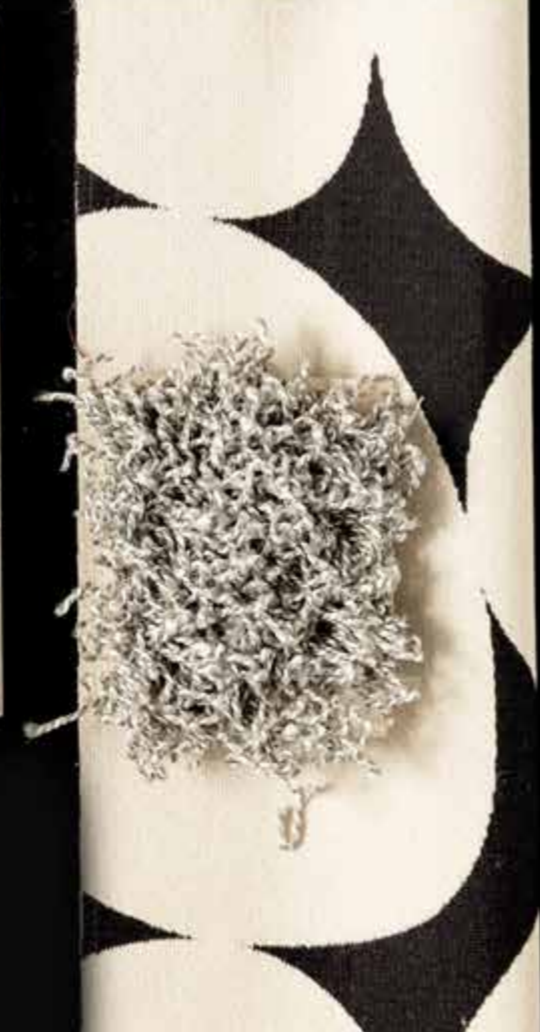

OFF

#LET'S SLEEP



273

ON OFF
SOLUTION



ALCOVA System
SYSTEM 20



273

ON OFF
SOLUTION

ALCOVA System





274
ON OFF
SOLUTION



BLOCK System
SYSTEM 32
SYSTEM 28
ON-OFF Sofa

#LET'S RELAX



#LET'S SLEEP



BLOCK System
SYSTEM 28
SYSTEM 32
ON-OFF Sofa
ON-OFF Club Chair

275

ON OFF
SOLUTION

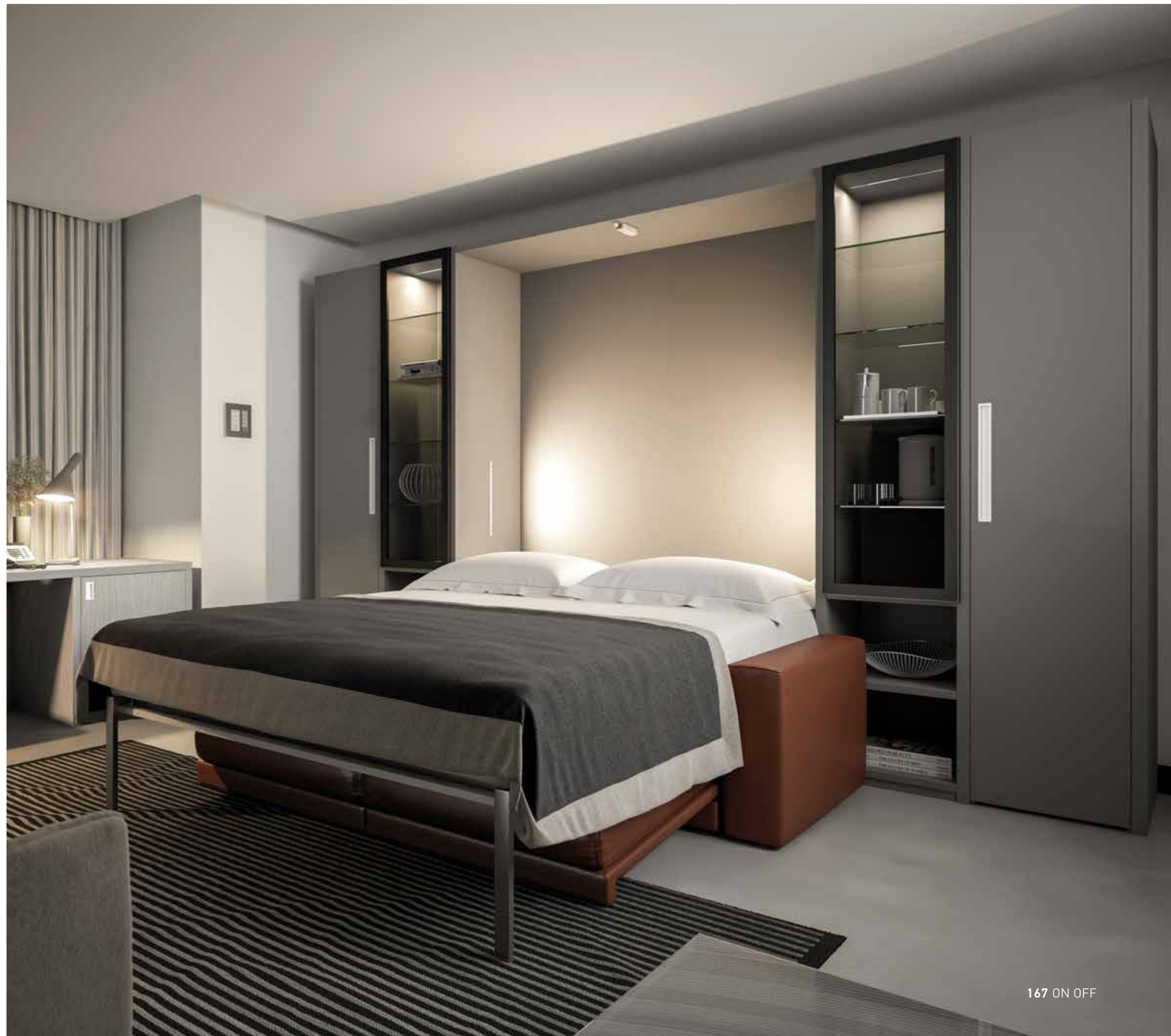

BLOCK System
SYSTEM 28
SYSTEM 32
ON-OFF Sofa
ON-OFF Club Chair



BLOCK System
ON-OFF Sofa
ON-OFF Club Chair
T-CLOUD Wall box
ON-OFF Fixed end coffee table



276
ON OFF
SOLUTION



BLOCK System
ON-OFF Sofa
ON-OFF Club Chair
T-CLOUD Wall box
ON-OFF Fixed end coffee table
Tavolo Estraibile / Pull-Out Table

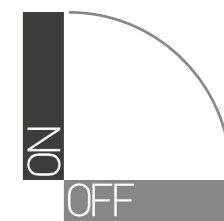

RESIDENTIAL





277
ON OFF
SOLUTION

BLOCK System
SYSTEM 20
FLIP Sofa
LINEUP Shelf
TWIST Rotating Table
PILL Pouf

277
ON OFF
SOLUTION



SYSTEM 20

#LET'S MEET



#LET'S DREAM

ALCOVA System
SYSTEM 28
PILL Pouff



BLOCK System
SYSTEM 20
ON-OFF Sofa
PILL Pouf
ABLE Armchair

279
ON OFF
SOLUTION



BLOCK System
SYSTEM 20
ON-OFF Sofa
PILL Pouf
ABLE Armchair

280
ON OFF
SOLUTION



ALCOVA System
PILL Pouf



188 ON OFF



COPRIRETE
BED FRAME COVER

189 ON OFF

TECHNICAL DATA

INDICE COMPOSIZIONI

COMPOSITION INDEX

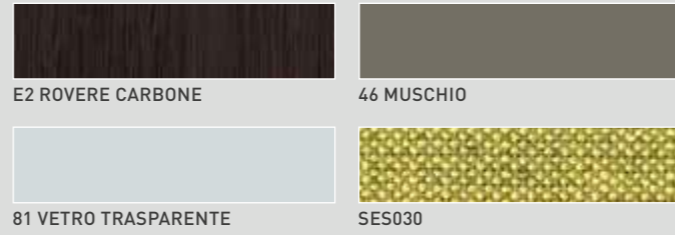

ON

OFF

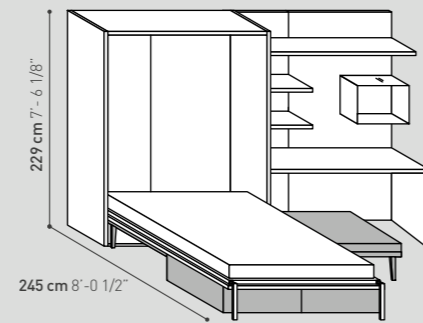
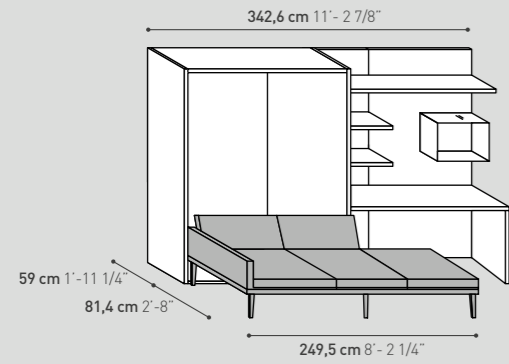

SMART HOME

51 m²

- ① Block System
- ② Flip divano
- ③ Boiserie
- ④ Twice System

- ① Block System
- ② Flip sofa
- ③ Boiserie
- ④ Twice System

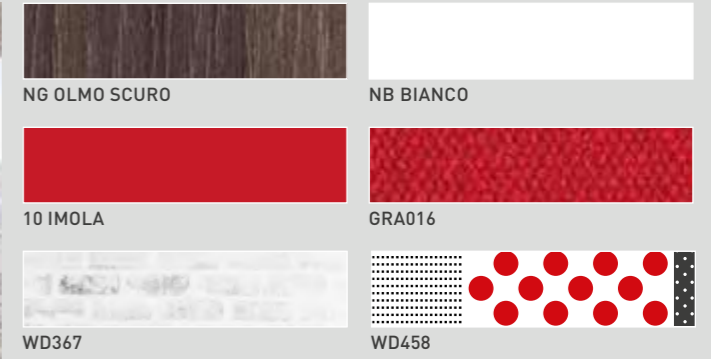
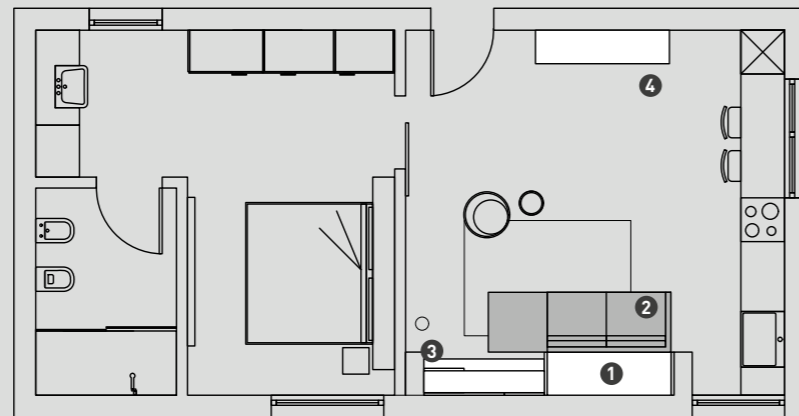

ON

OFF

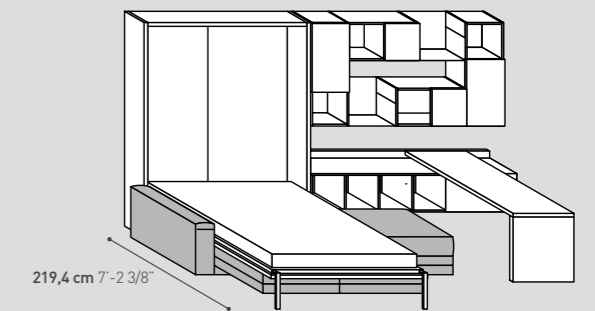
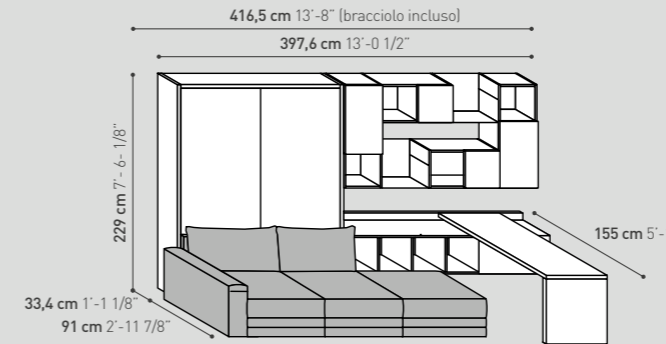

SMART HOME

35 m²

- ① Block System
- ② On-Off divano
- ③ Pill Pouf
- ④ Twice System

- ① Block System
- ② On-Off sofa
- ③ Pill Pouf
- ④ Twice System

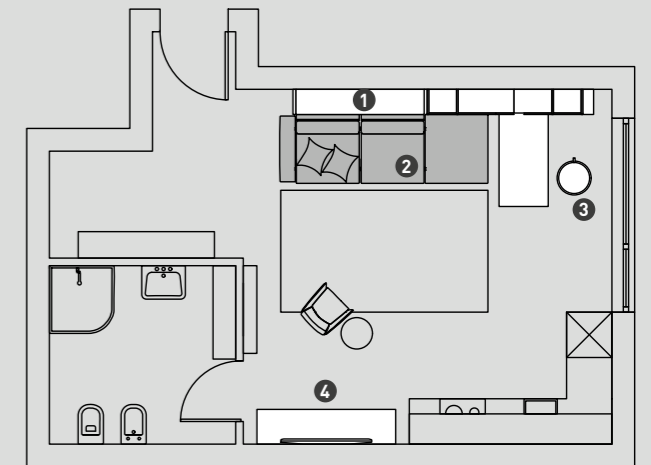

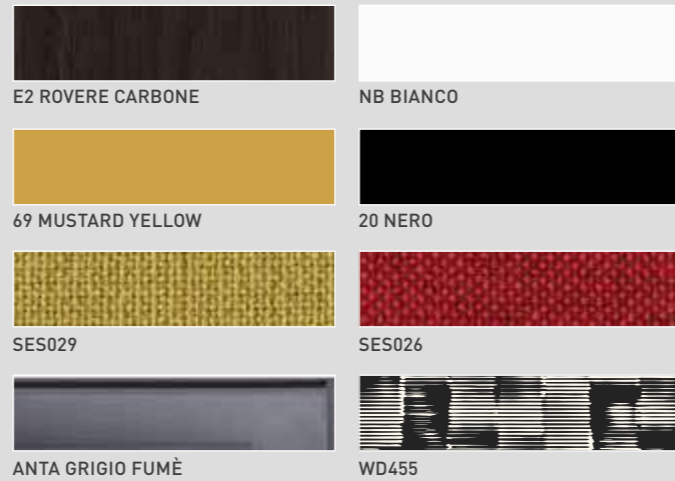

ON

OFF

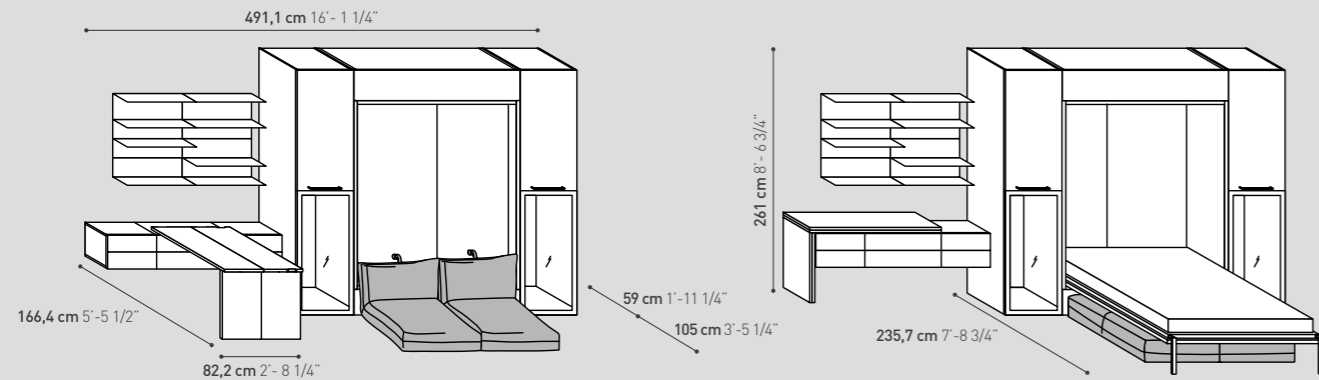

SMART HOME

53 m²

- 1 Alcova Light
- 2 System 20
- 3 Fluffy divano reclinabile
- 4 Lineup mensola
- 5 Twist tavolo girevole e apribile
- 6 Pill Pouf

- 1 Alcova Light
- 2 System 20
- 3 Fluffy reclining sofa
- 4 Lineup shelf
- 5 Twist openable turning table
- 6 Pill Pouf

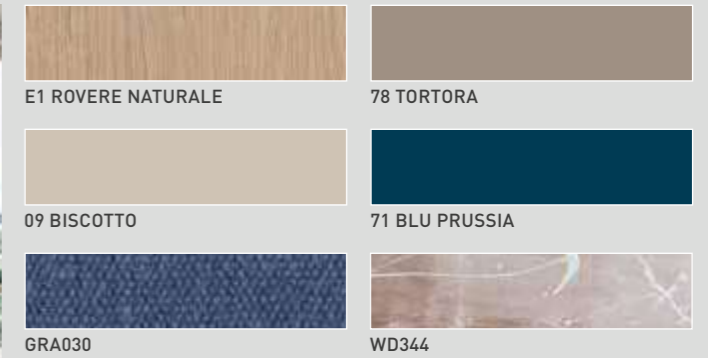
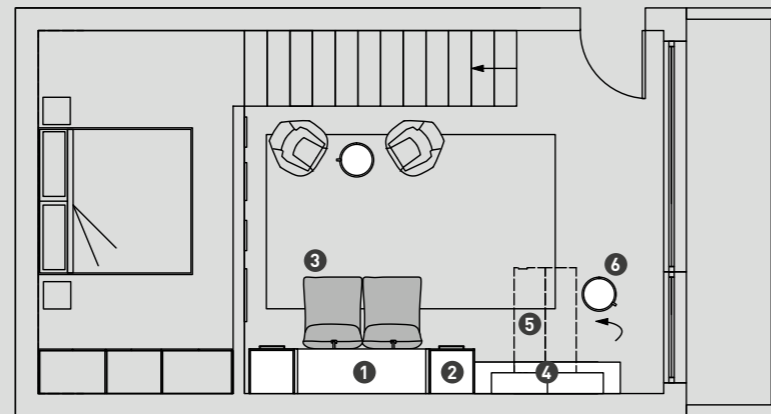

ON

OFF

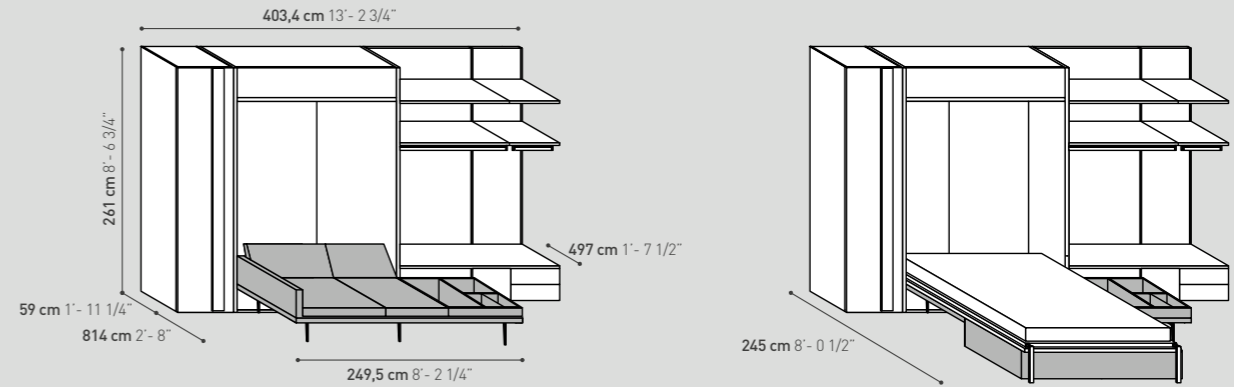

SMART HOME

45 m²

- 1 Block System
- 2 System 20
- 3 Code maniglia
- 4 Ludo cremagliera
- 5 Flip divano

- 1 Block System
- 2 System 20
- 3 Code handle
- 4 Ludo rack
- 5 Flip sofa

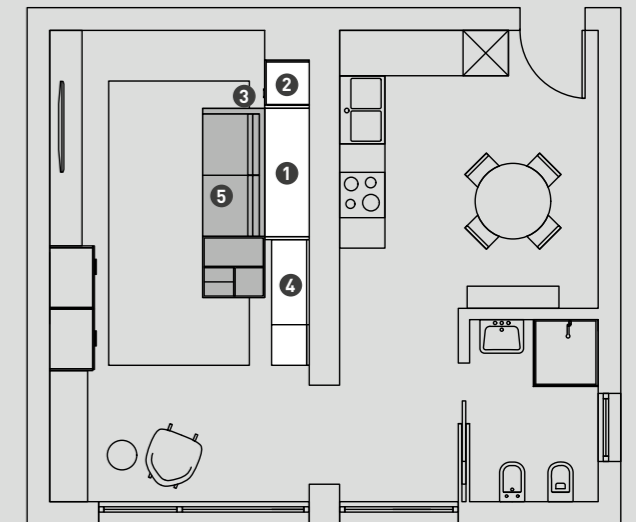

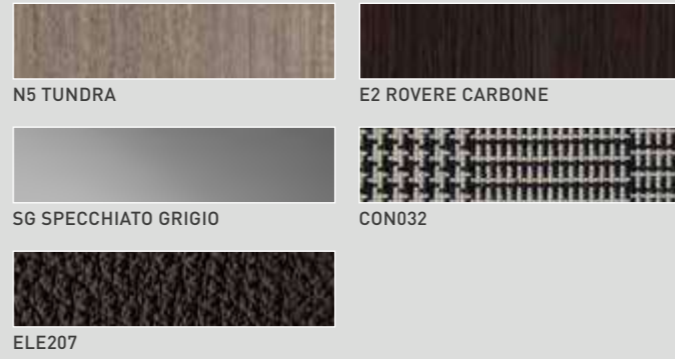

ON

OFF

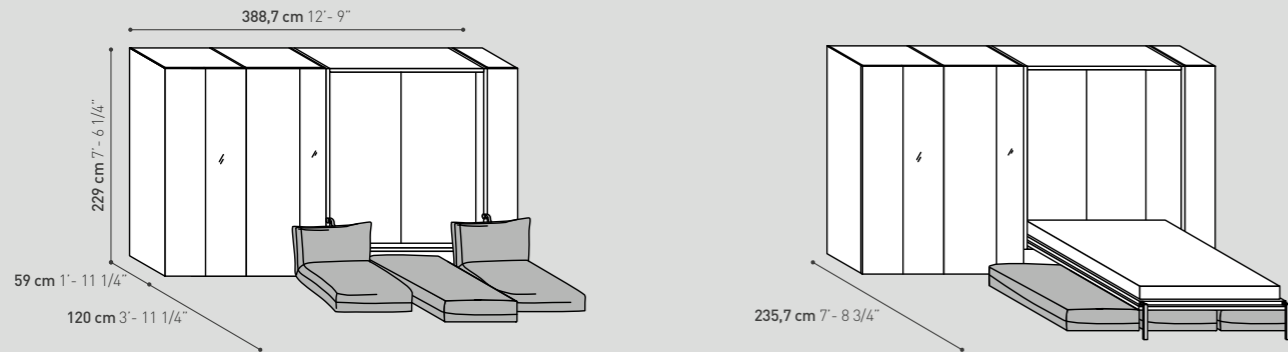

SMART HOME
47 m²

- 1 Alcova Light
- 2 System 20
- 3 Magic Mirror
- 4 Fluffy
- 5 Slip

- 1 Alcova Light
- 2 System 20
- 3 Magic Mirror
- 4 Fluffy
- 5 Slip

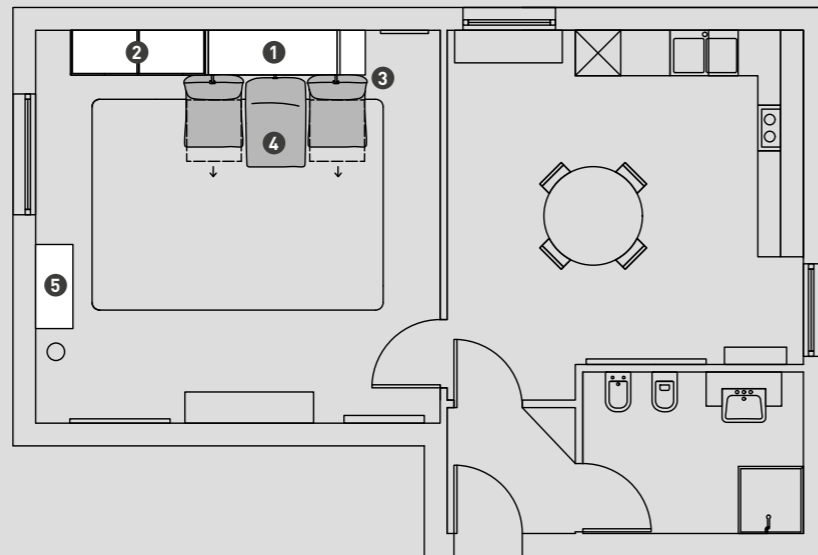

ON

OFF

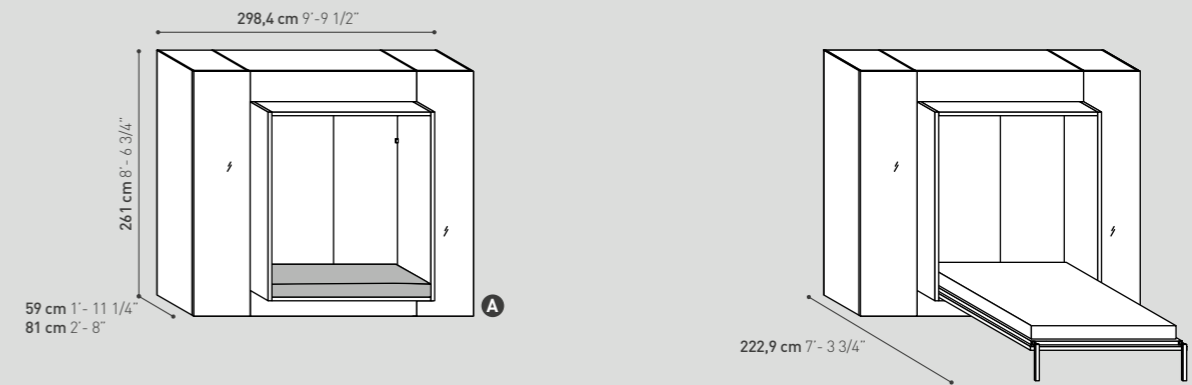

SMART HOME
48 m²

- 1 Alcova System
- 2 System 20
- 3 Twice System
- 4 Lineup mensola
- 5 Pill Pouf

- 1 Alcova System
- 2 System 20
- 3 Twice System
- 4 Lineup shelf
- 5 Pill Pouf

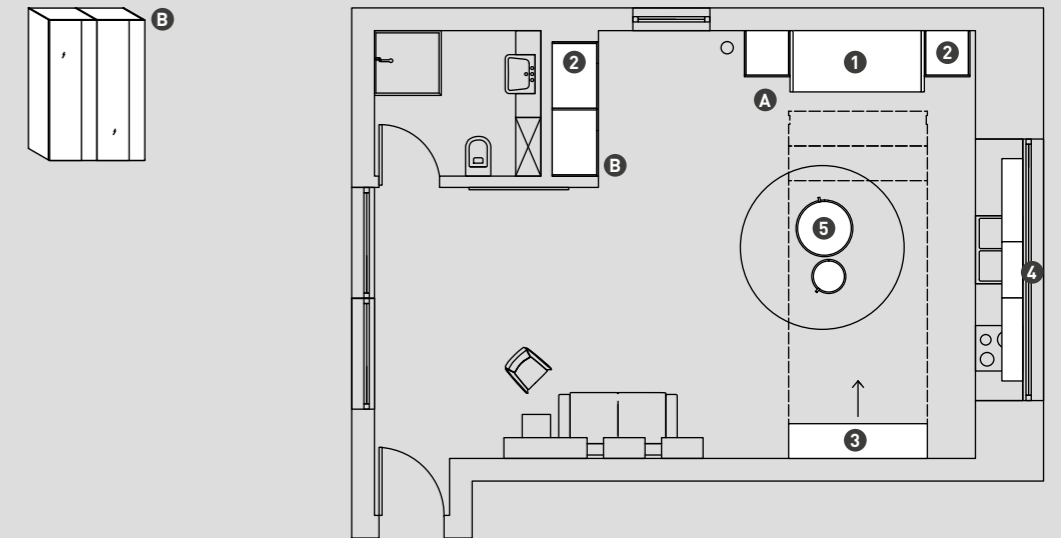

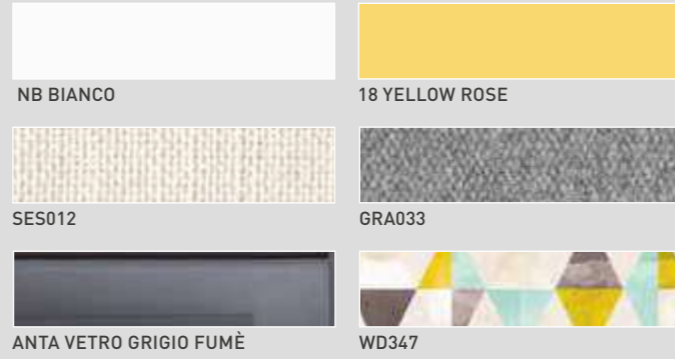

ON

OFF

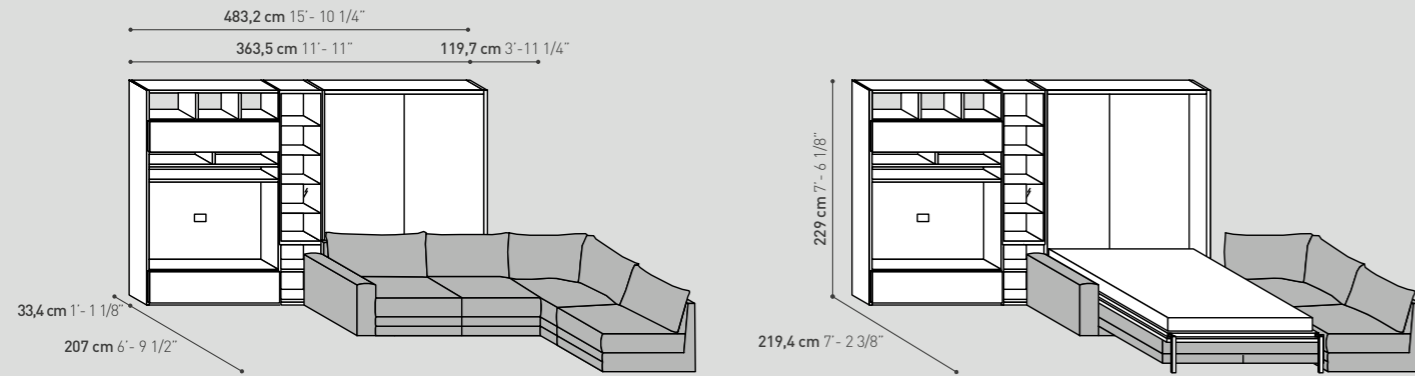

SMART HOME
50 m²

- 1 Block System
- 2 System 28
- 3 On-Off divano
- 4 On-Off poltrona con contenitore

- 1 Block System
- 2 System 28
- 3 On-Off sofa
- 4 On-Off Club chair with storage unit

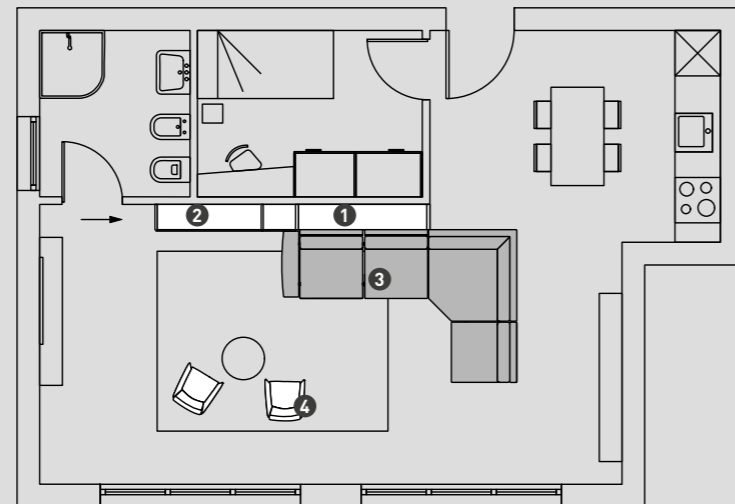

ON

OFF

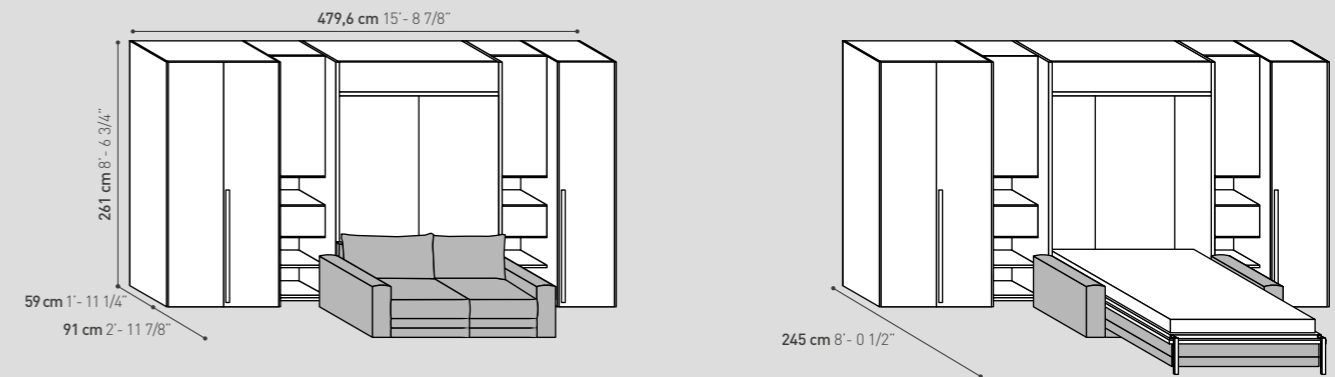

SMART HOME
36 m²

- 1 Block System
- 2 System 28
- 3 System 32
- 4 On-Off divano

- 1 Block System
- 2 System 28
- 3 System 32
- 4 On-Off sofa

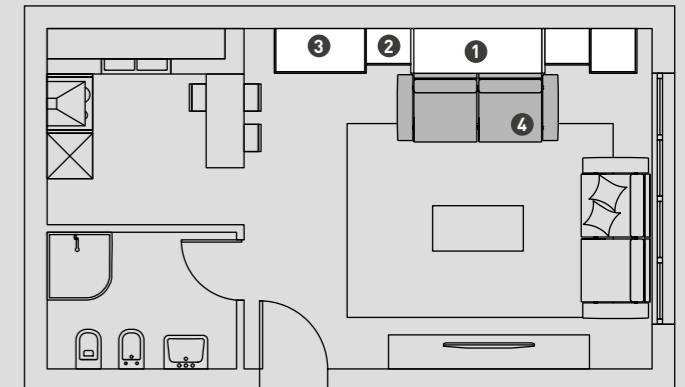

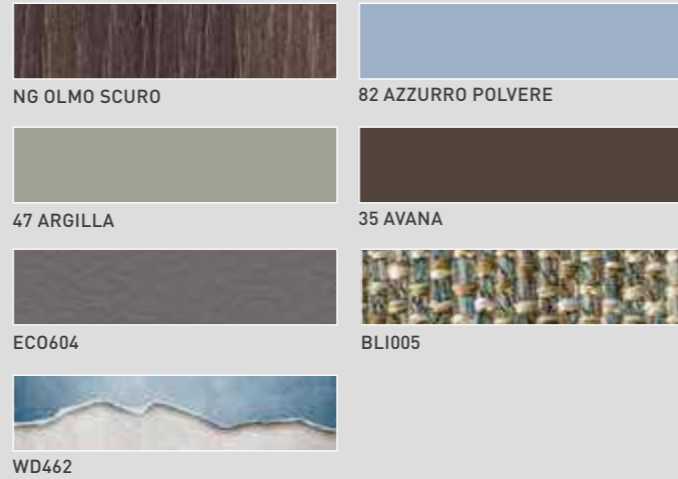

ON

OFF

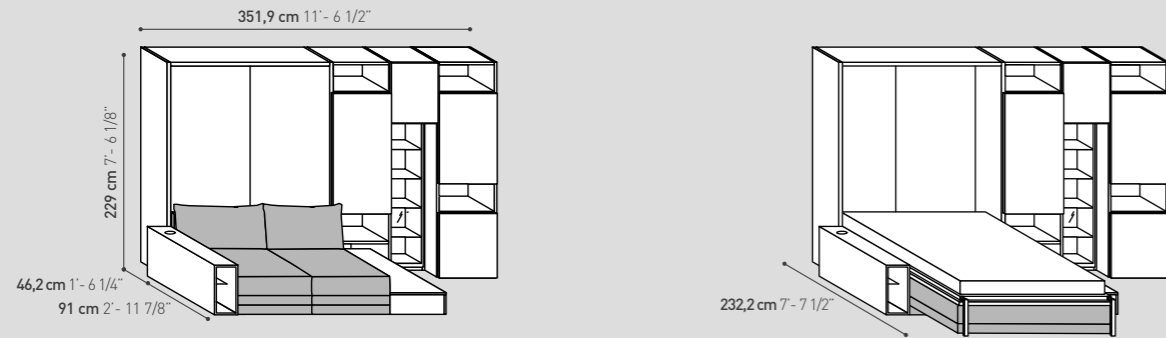

COMFORT HOME
83 m²

- 1 Block System
- 2 System 28
- 3 Sound bracciolo
- 4 On-Off tavolino con contenitore
- 5 On-Off divano
- 6 Pill pouf

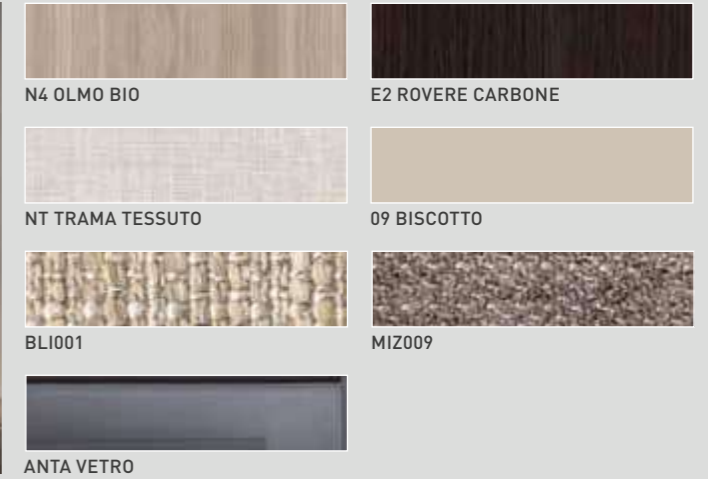
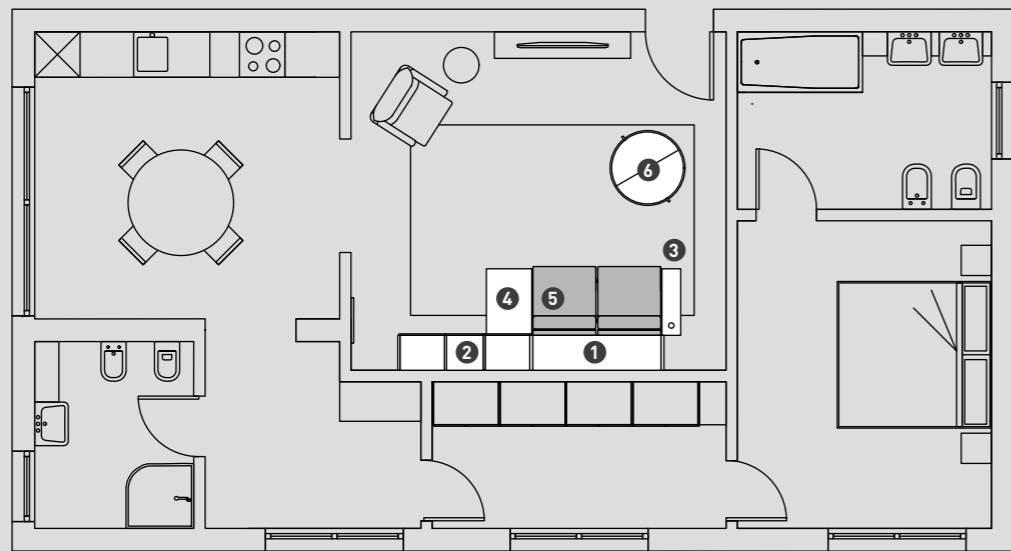

ON

OFF

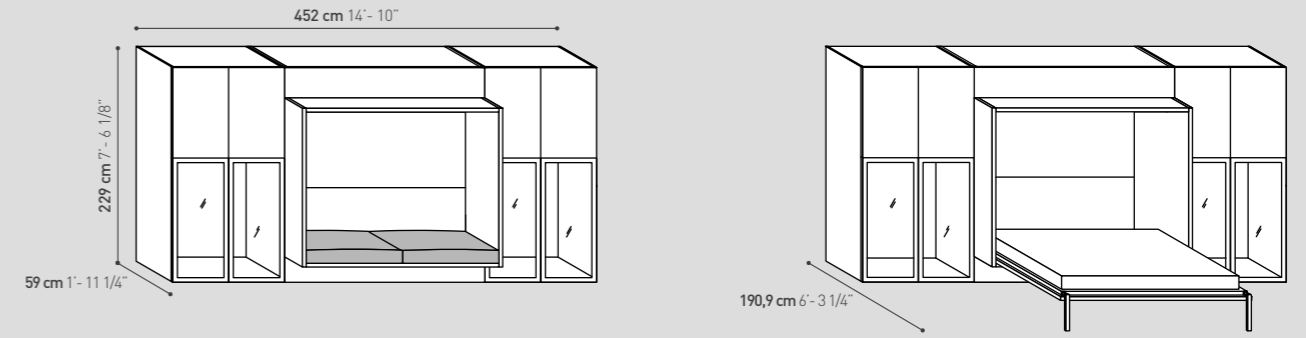

COMFORT HOME
89 m²

- 1 Alcova System
- 2 System 20
- 3 Pill Pouf
- 4 Able poltrona ribaltabile
- 5 Twice System

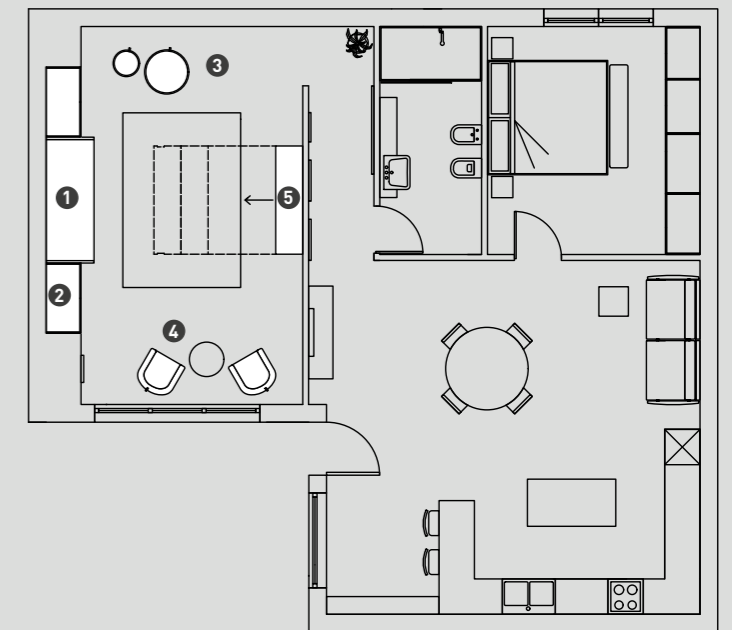

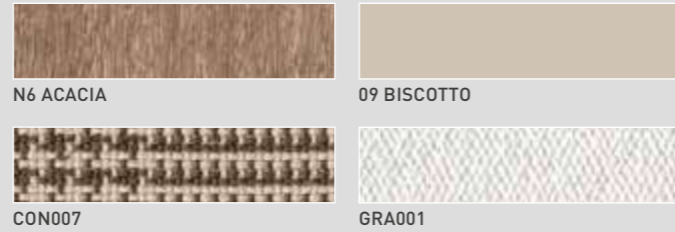

ON

OFF

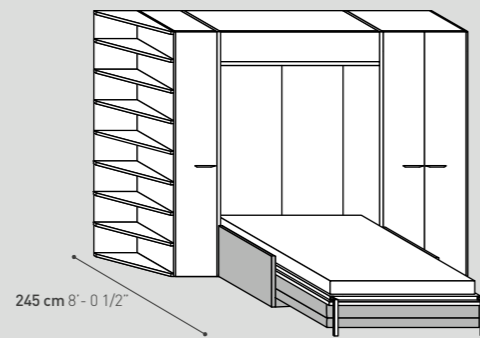
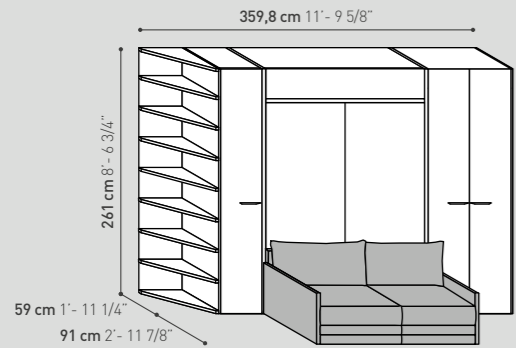

COMFORT HOME

94 m²

- 1 Block System
- 2 System 20
- 3 Elemento terminale
- 4 On-Off divano

- 1 Block System
- 2 System 20
- 3 End Unit
- 4 On-Off divano

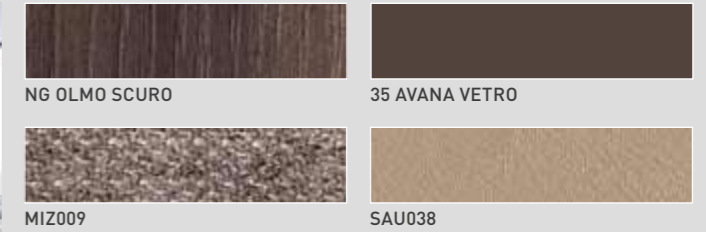
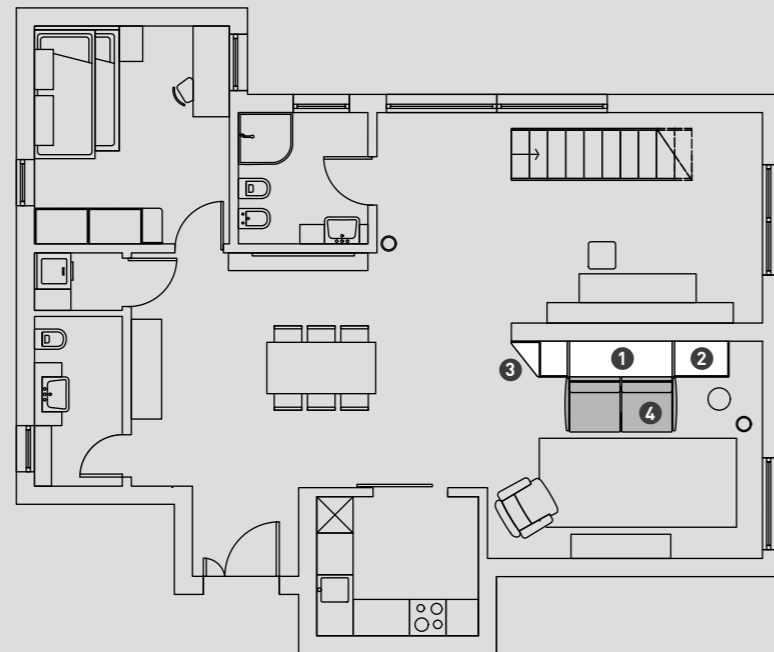

ON

OFF

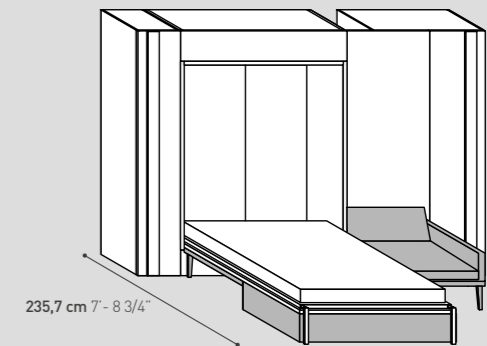
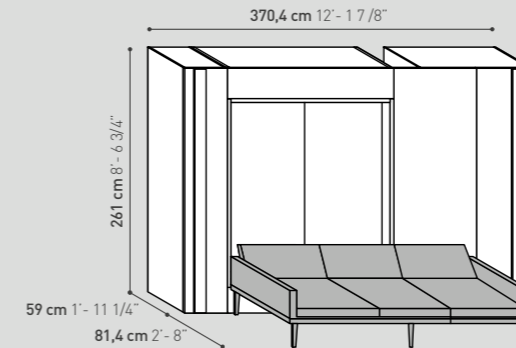

COMFORT HOME

96 m²

- 1 Alcova Light
- 2 Carry
- 3 System 20
- 4 Code maniglia
- 5 Flip divano
- 6 Pill pouf

- 1 Alcova Light
- 2 Carry
- 3 System 20
- 4 Code handle
- 5 Flip sofa
- 6 Pill pouf

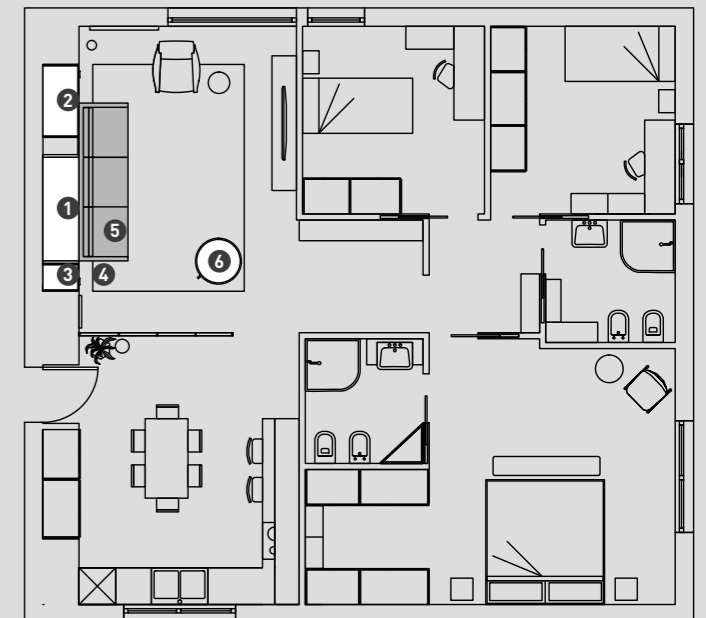



ON

OFF

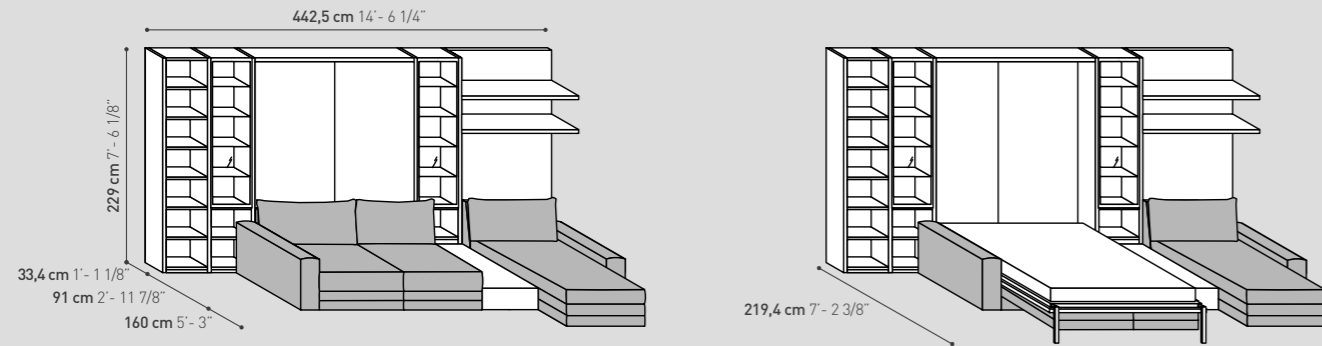

COMFORT HOME
101 m²

- 1 Block System
- 2 System 28
- 3 Boiserie
- 4 Tavolo intermedio con contenitore
- 5 On-Off divano

- 1 Block System
- 2 System 28
- 3 Boiserie
- 4 Intermediate coffee table with storage
- 5 On-Off sofa

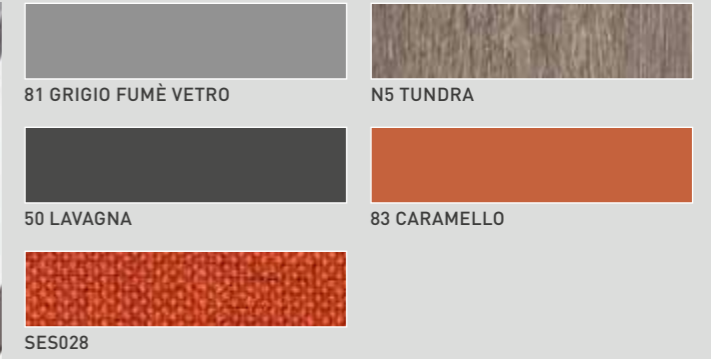
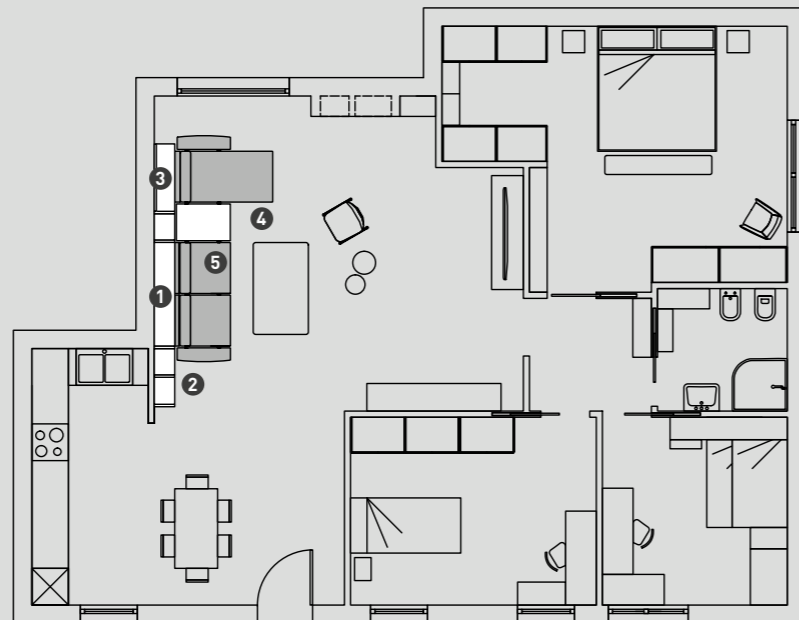

ON

OFF

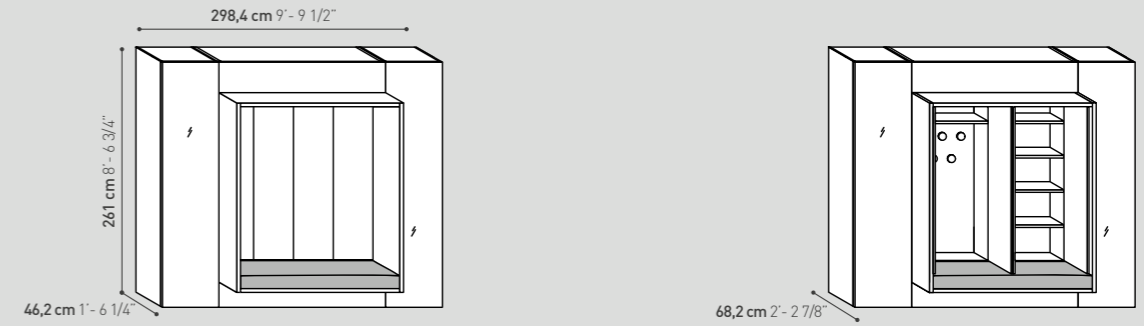

COMFORT HOME
101 m²

- 1 Alcova System
- 2 System 20

- 1 Alcova System
- 2 System 20

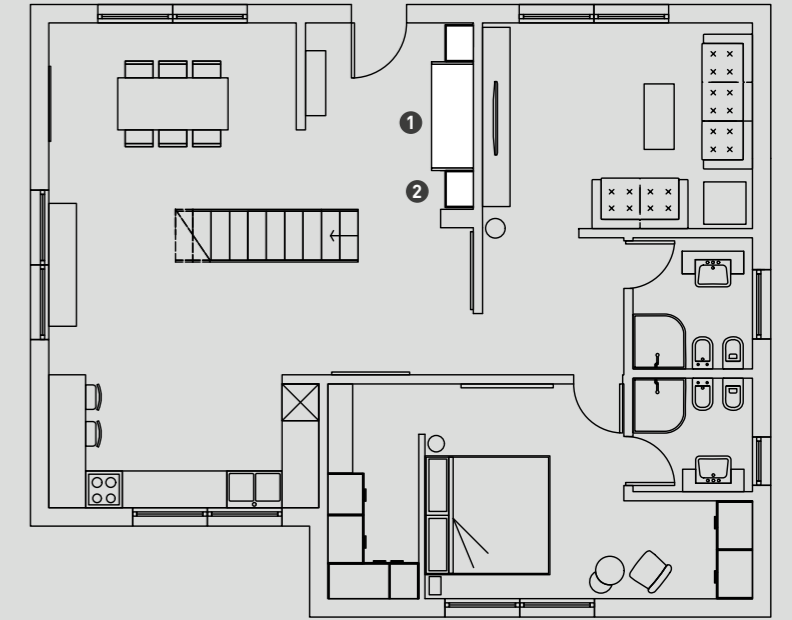

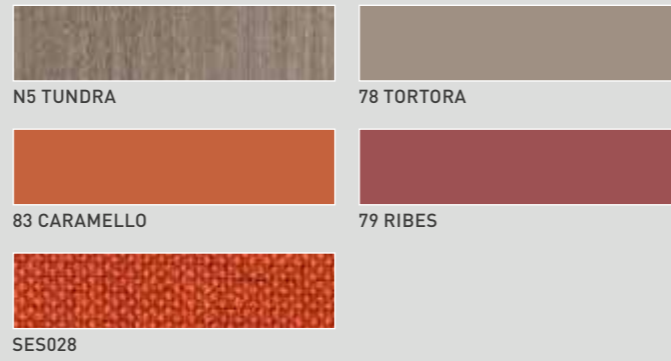

ON

OFF

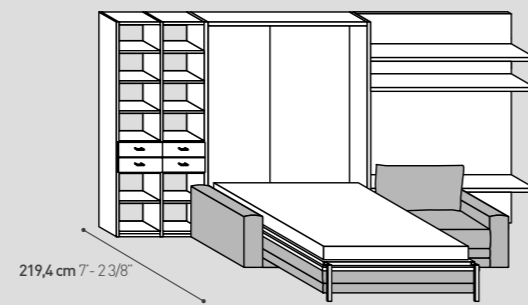
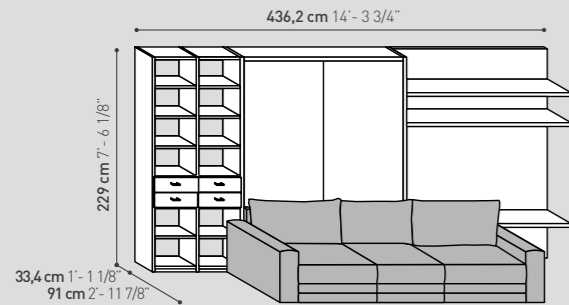

COMFORT HOME
119 m²

- 1 Block System
- 2 System 28
- 3 Boiserie
- 4 On-Off divano
- 5 Comp 269

- 1 Block System
- 2 System 28
- 3 Boiserie
- 4 On-Off divano
- 5 Comp 269

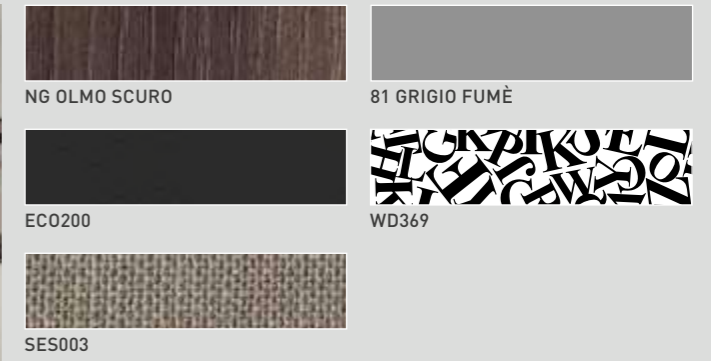
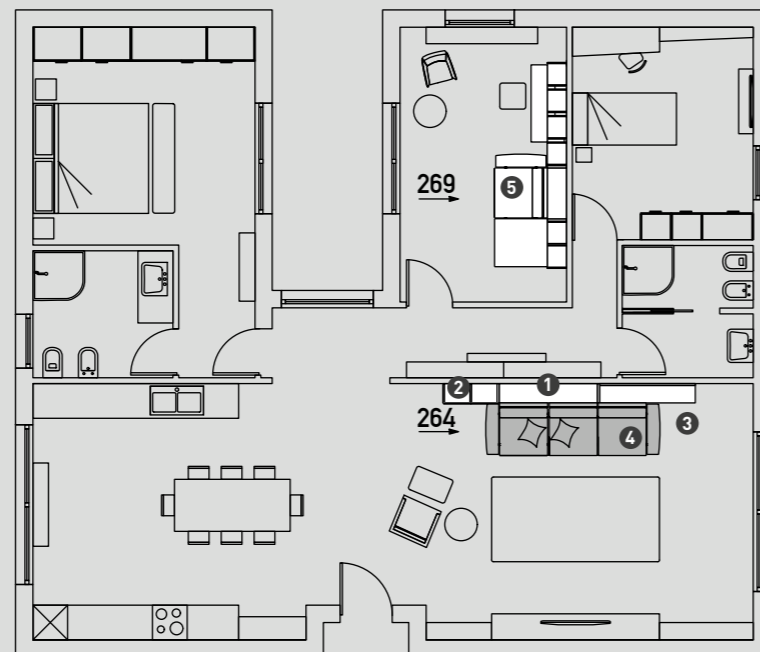

ON

OFF

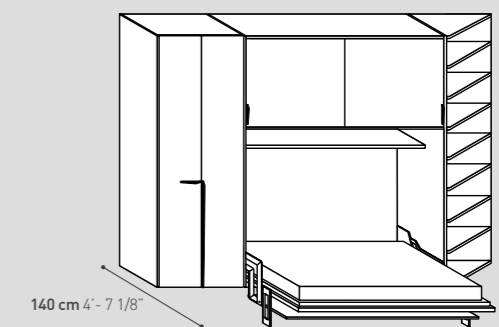
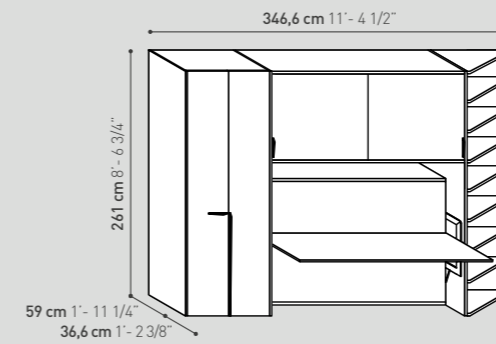

HOME OFFICE
93 m²

- 1 Block System
- 2 System 32
- 3 Elemento terminale
- 4 Twice System
- 5 Pill Pouf

- 1 Block System
- 2 System 32
- 3 End Unit
- 4 Twice System
- 5 Pill Pouf

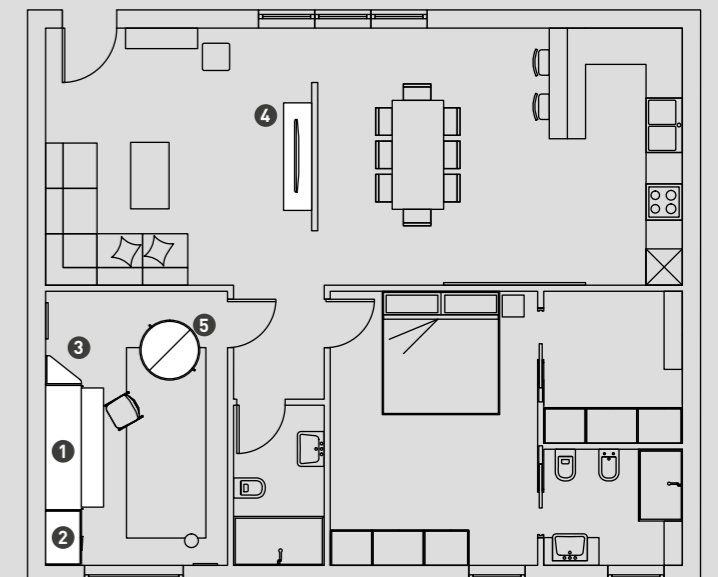

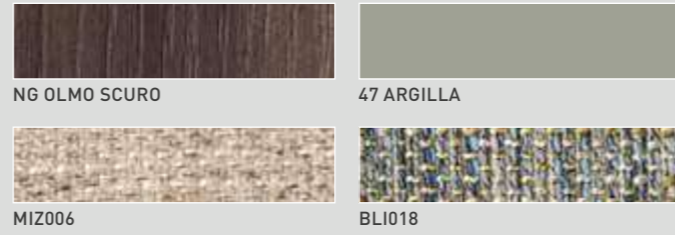

ON

OFF

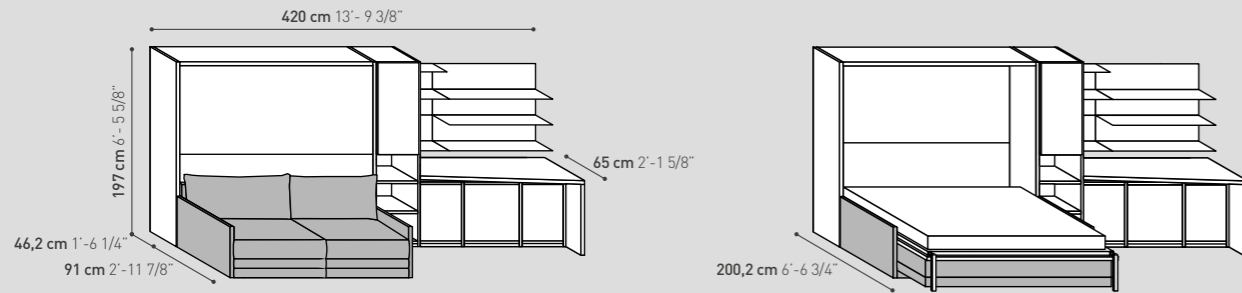

HOME OFFICE
134 m²

- 1 Block System
- 2 System 28
- 3 On-Off divano
- 4 Lineup mensola
- 5 Pill Pouf

- 1 Block System
- 2 System 28
- 3 On-Off sofa
- 4 Lineup shelf
- 5 Pill Pouf

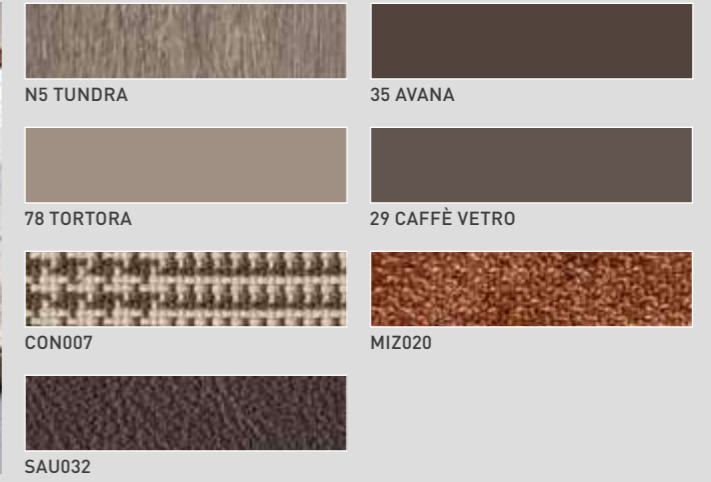
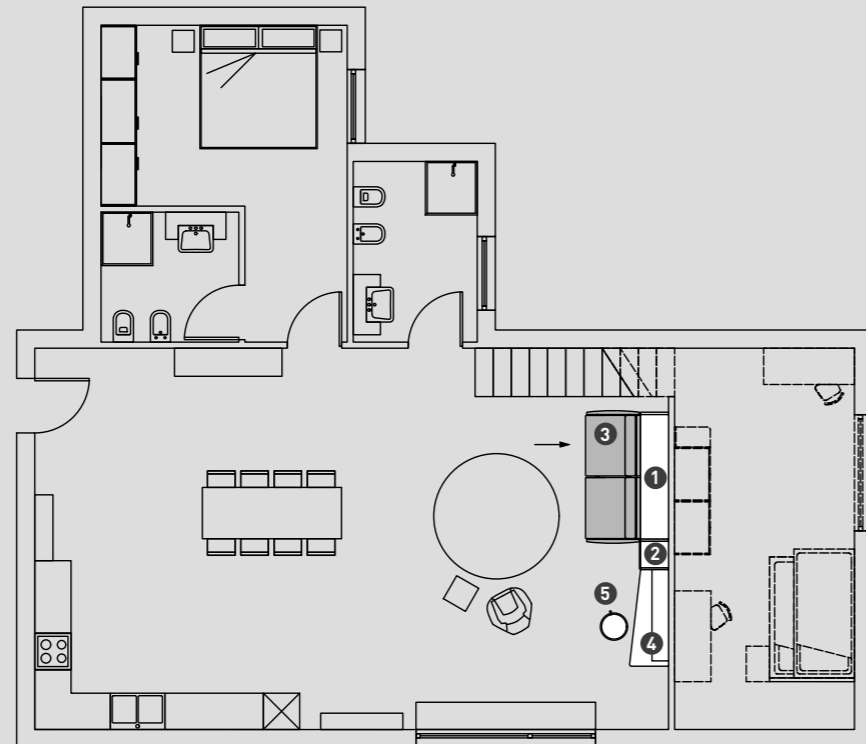

ON

OFF

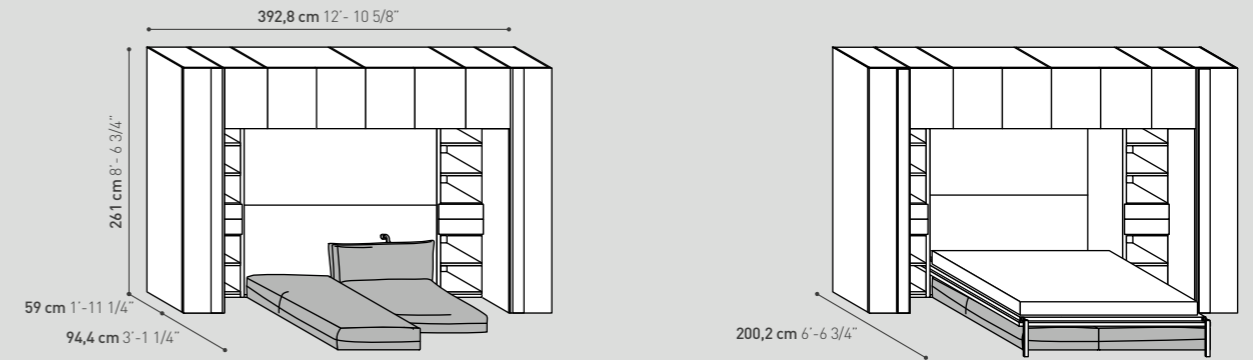

HOME OFFICE
62 m²

- 1 Block System
- 2 Pensili in appoggio
- 3 System 20
- 4 Code maniglia
- 5 Fluffy divano reclinabile
- 6 Pill pouf

- 1 Block System
- 2 Wall unit with underlying support
- 3 System 20
- 4 Code handle
- 5 Fluffy reclining sofa
- 6 Pill pouf

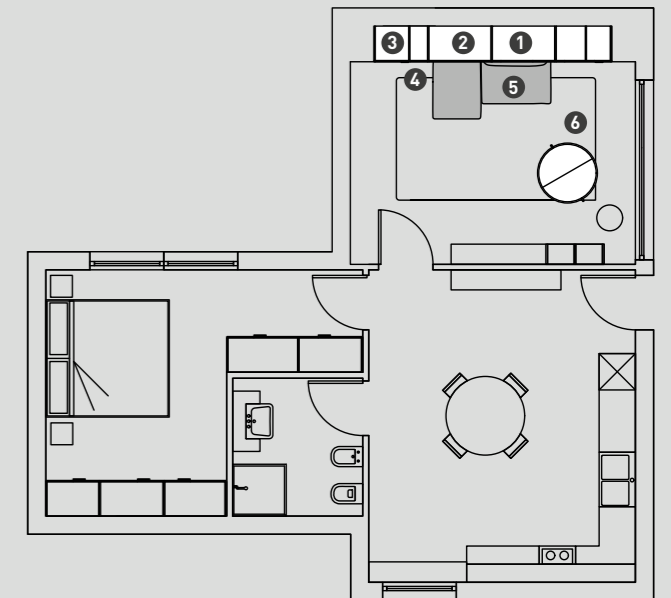



ON

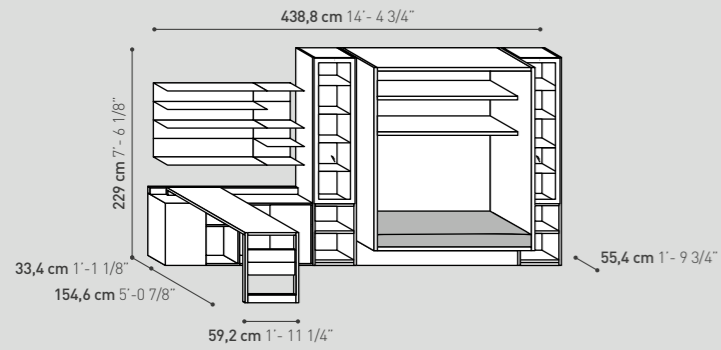

HOME OFFICE

61 m²

- 1 Alcova System
- 2 System 28
- 3 Lineup mensola
- 4 Tavolo con piede Frame
- 5 Twice System
- 6 Able poltrona ribaltabile
- 7 Pill pouf

- 1 Alcova System
- 2 System 28
- 3 Lineup shelf
- 4 Table with Frame foot
- 5 Twice System
- 6 Able flip-open armchair
- 7 Pill pouf

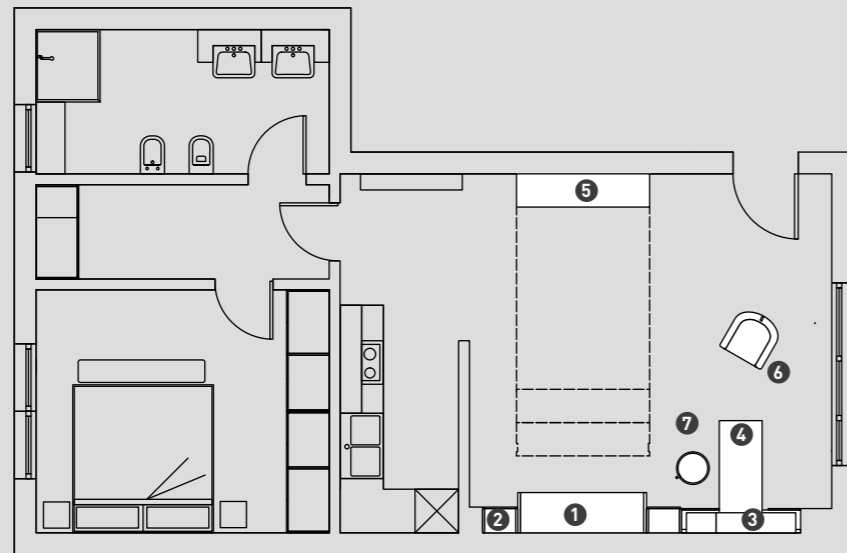

210 ON OFF

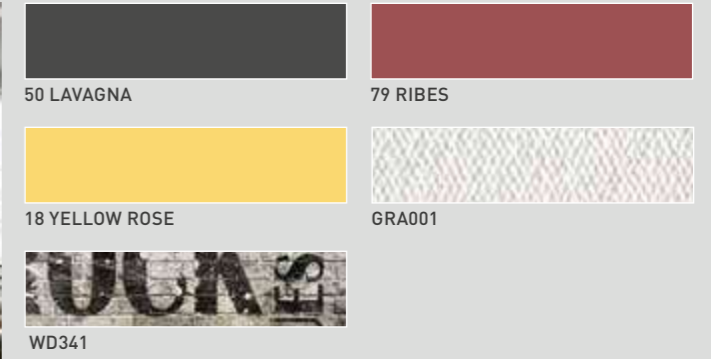

ON

OFF

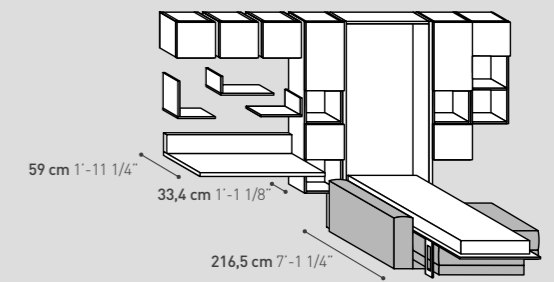
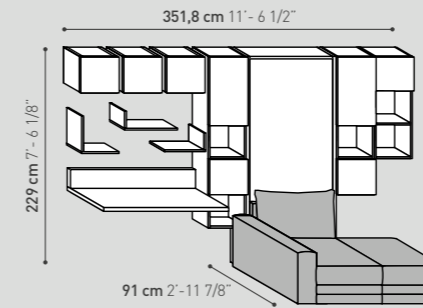

HOME OFFICE

85 m²

- 1 Block System
- 2 Pensili verticali
- 3 T-Box mensola
- 4 On-Off poltrona e pouf

- 1 Block System
- 2 Vertical wall boxes
- 3 T-Box shelf
- 4 On-Off armchair and pouf

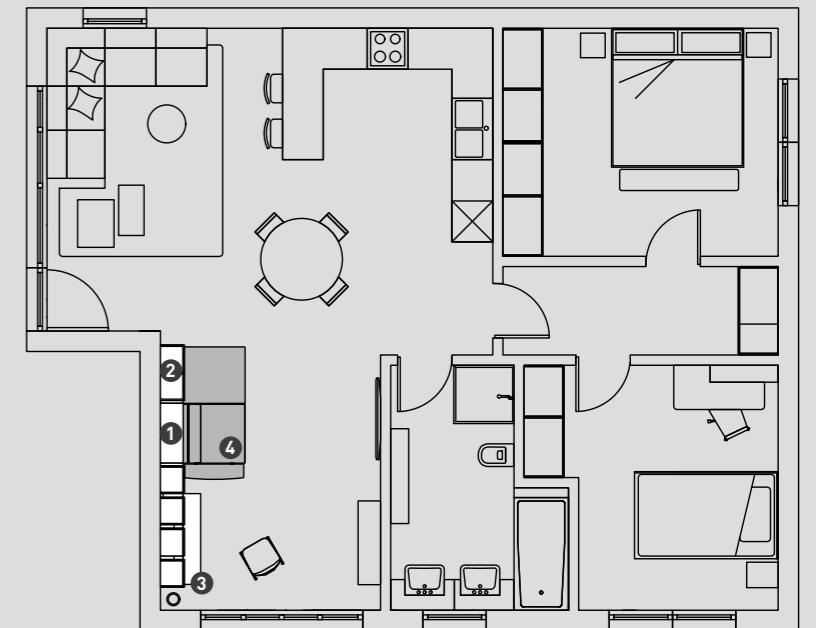

211 ON OFF

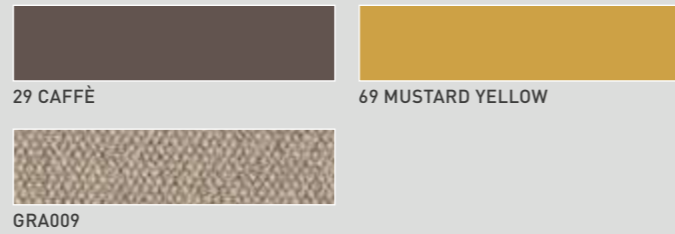

ON

OFF

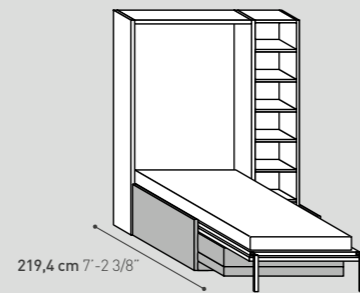
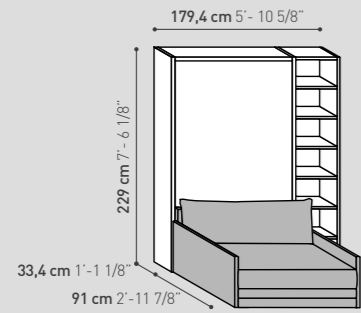

HOME OFFICE

91 m²

- 1 Block System
- 2 System 28
- 3 On-Off divano

- 1 Block System
- 2 System 28
- 3 On-Off sofa

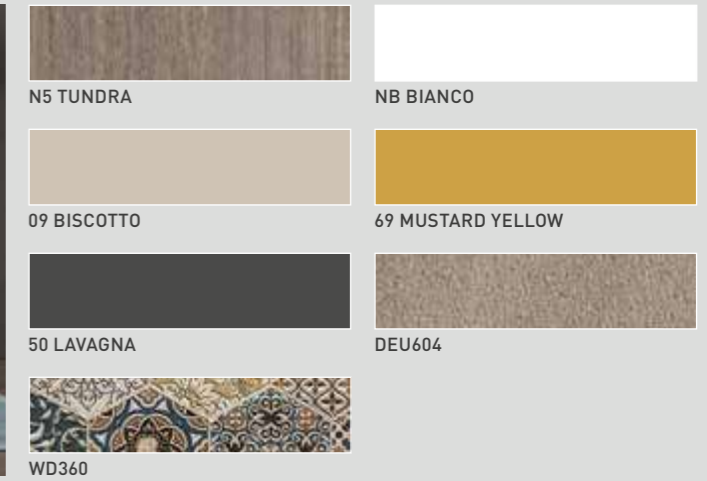
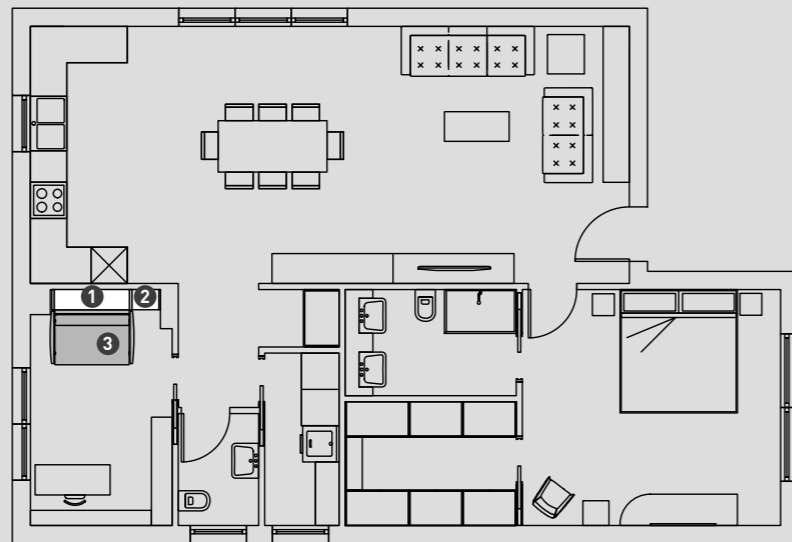

ON

OFF

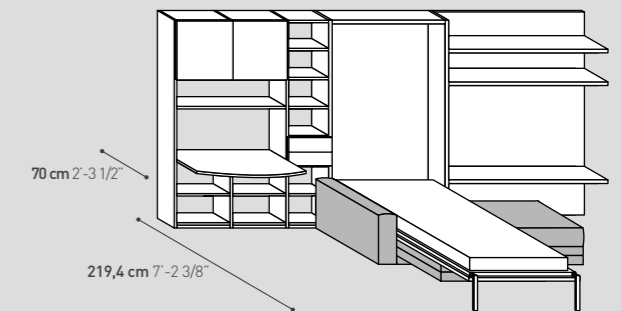
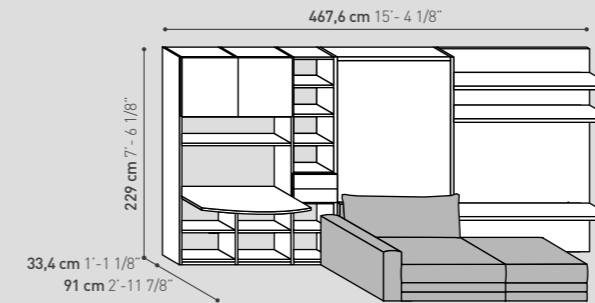

HOME OFFICE

110 m²

- 1 Block System
- 2 System 28
- 3 Boiserie
- 4 On-Off divano

- 1 Block System
- 2 System 28
- 3 Boiserie
- 4 On-Off sofa

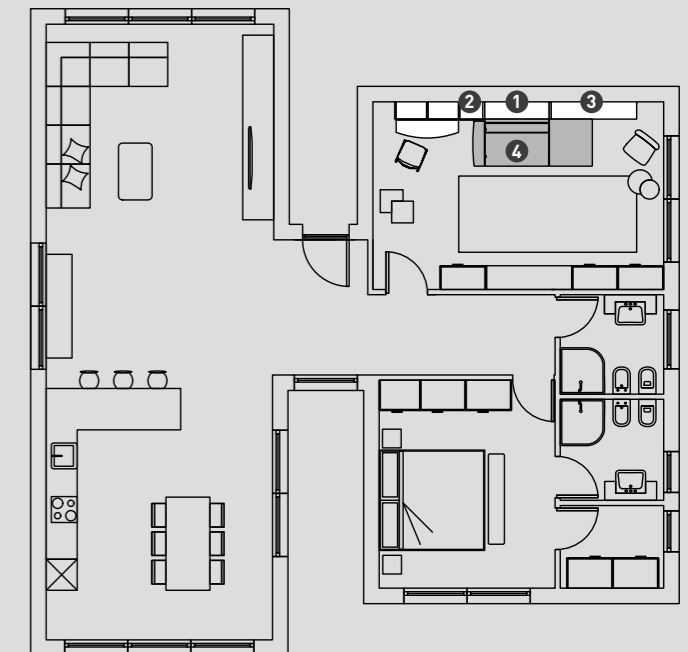

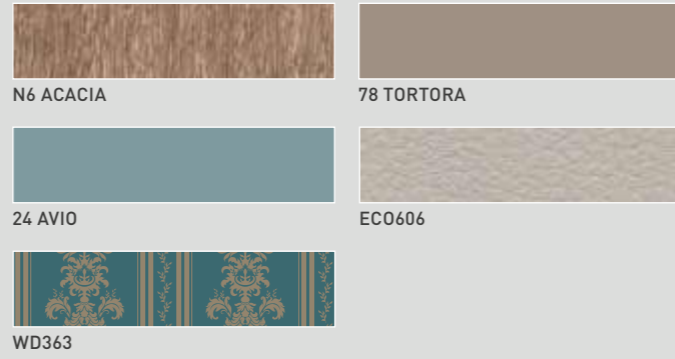

ON

OFF

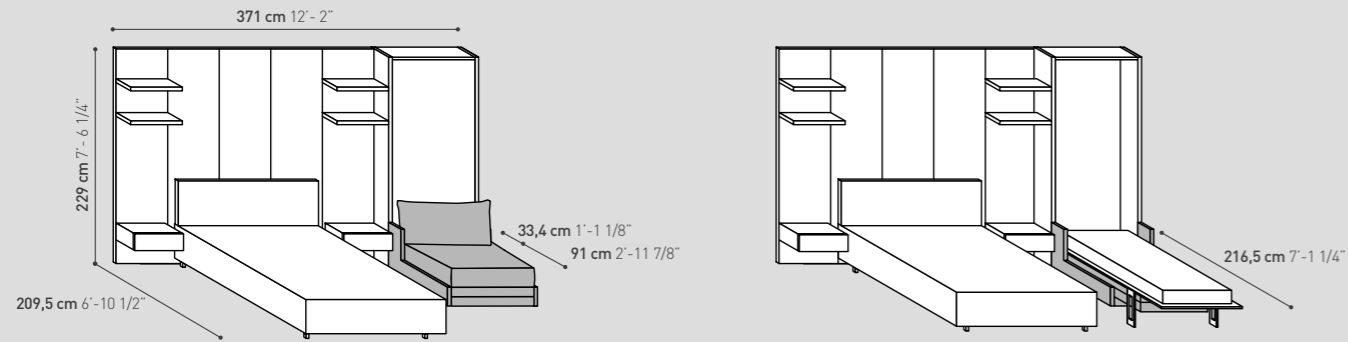

HOTEL
27 m²

- 1 Block System
- 2 Comodini pensili
- 3 Boiserie
- 4 Letto Clio
- 5 On-Off poltrona

- 1 Block System
- 2 Wall drawers
- 3 Boiserie
- 4 Clio bed
- 5 On-Off armchair

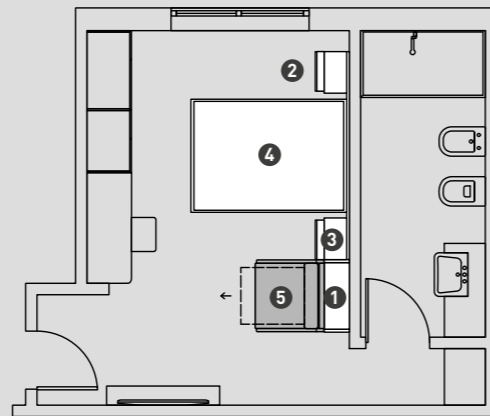

ON

OFF

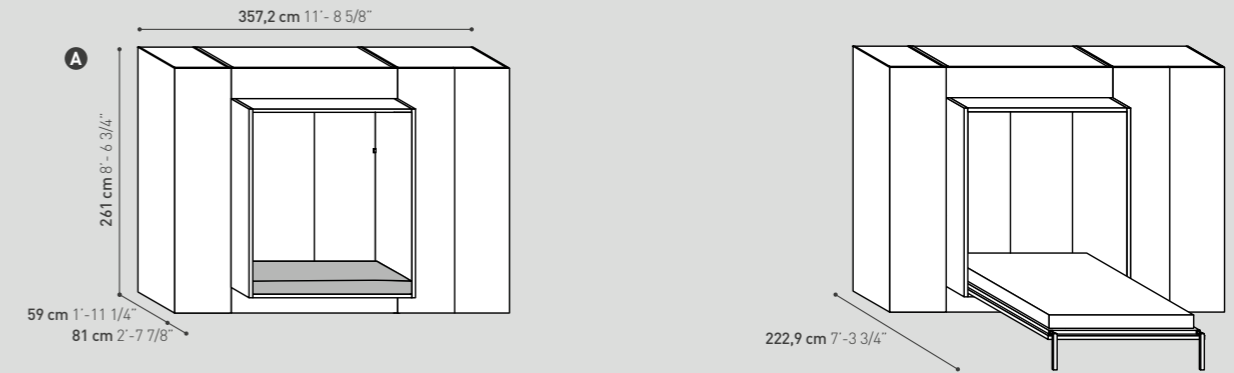

HOTEL
46 m²

- 1 Alcova System
- 2 System 20

- 1 Alcova System
- 2 System 20

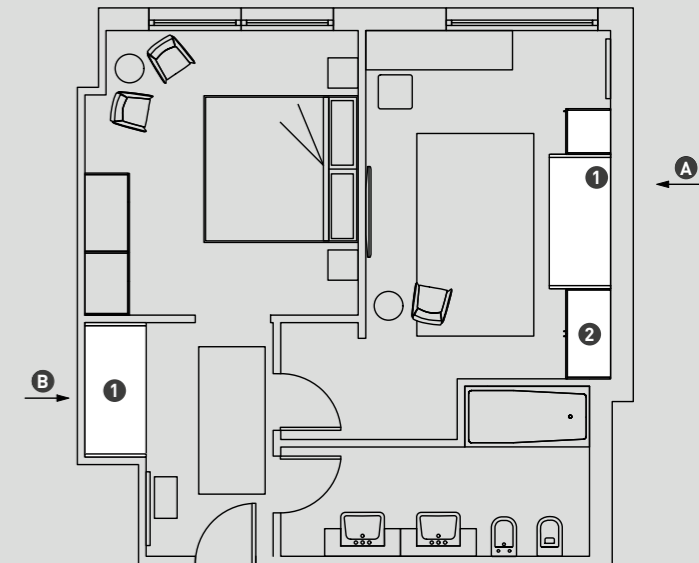
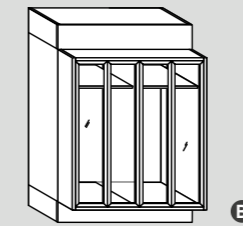



ON

OFF

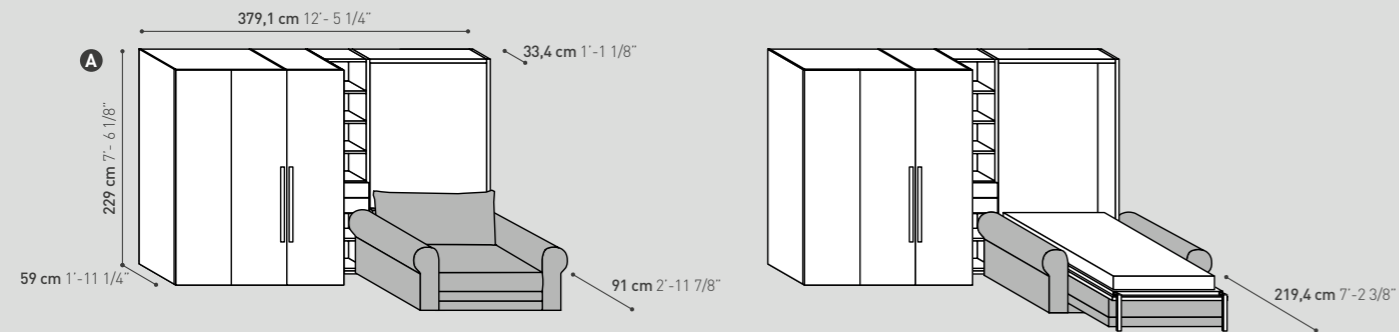

HOTEL
28 m²

- 1 Block System
- 2 System 28
- 3 System 20
- 4 On-Off divano
- 5 Porta Valigie
- 6 Anta per frigorifero

- 1 Block System
- 2 System 28
- 3 System 20
- 4 On-Off sofa
- 5 Suitcase top
- 6 Door for fridge

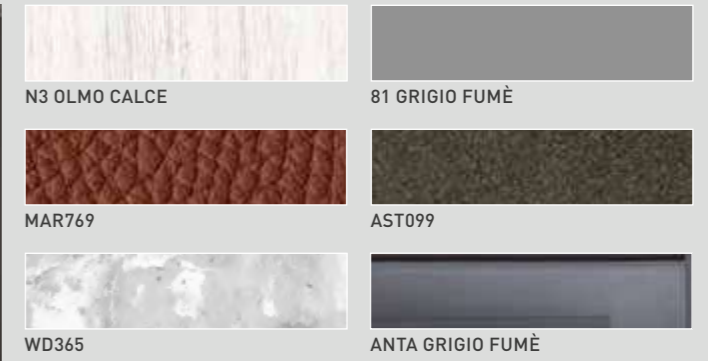
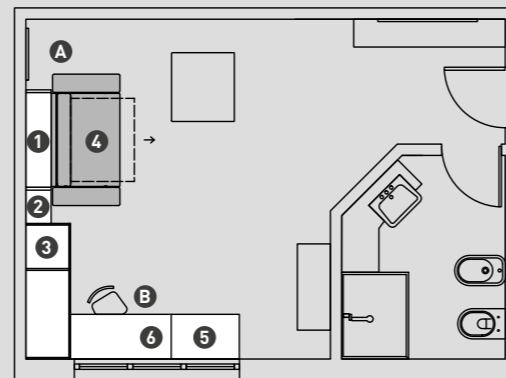
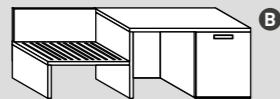

ON

OFF

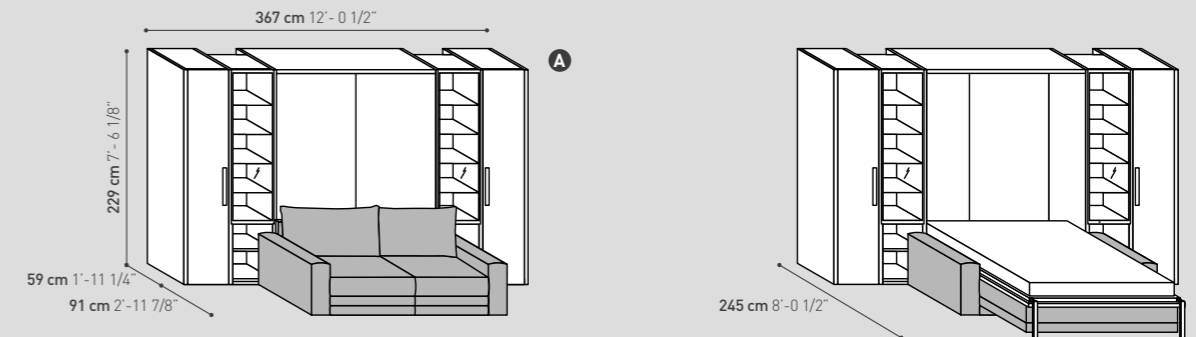

HOTEL
27 m²

- 1 Block System
- 2 System 28
- 3 System 32
- 4 On-Off divano
- 5 Anta per frigo
- 6 On-Off poltroncina con contenitore

- 1 Block System
- 2 System 28
- 3 System 32
- 4 On-Off sofa
- 5 Door for fridge
- 6 On-Off Club Chair with storage unit

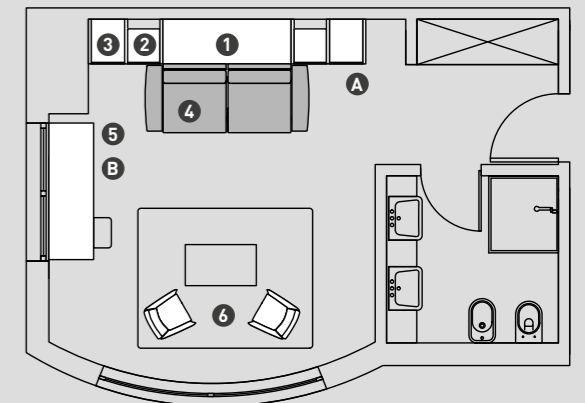
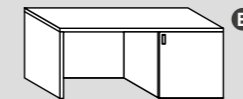

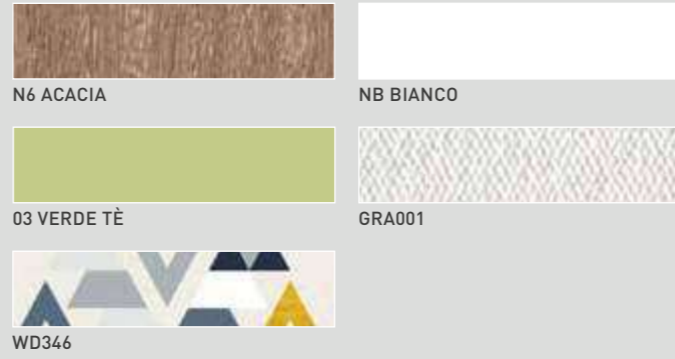

ON

OFF

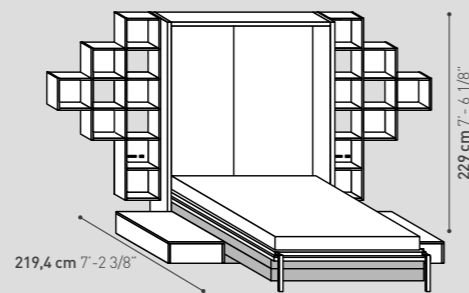
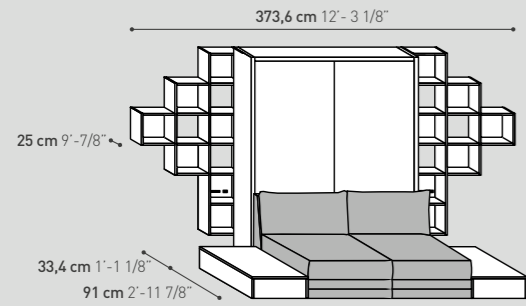

HOTEL
28 m²

- 1 Block System
- 2 T-Cloud
- 3 Tavolo con contenitore
- 4 On-Off divano
- 5 On-Off sedia con contenire
- 6 Tavolo estraibile

- 1 Block System
- 2 T-Cloud
- 3 Coffee table with storage unit
- 4 On-Off sofa
- 5 On-Off chair with storage unit
- 6 Pull-out table

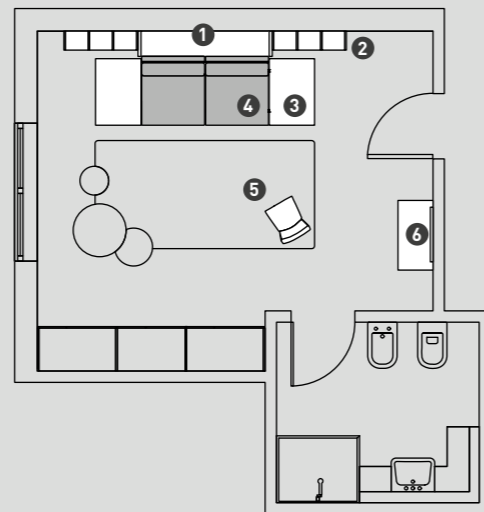

218 ON OFF

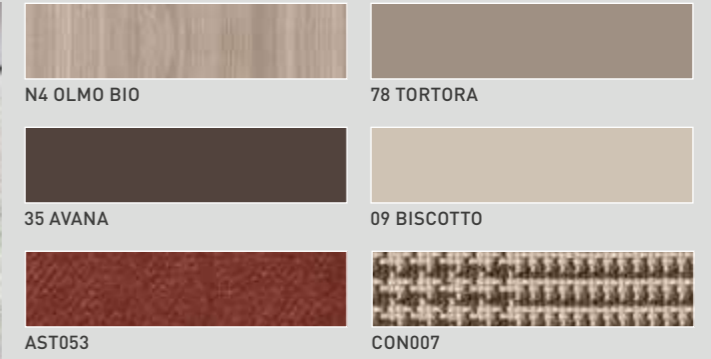

ON

OFF

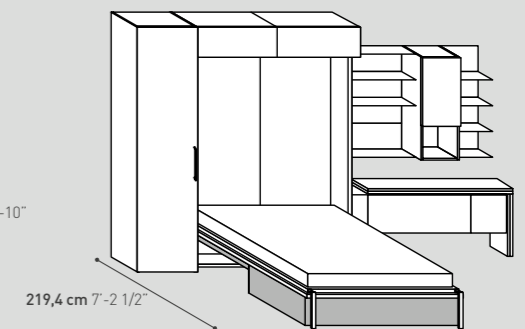
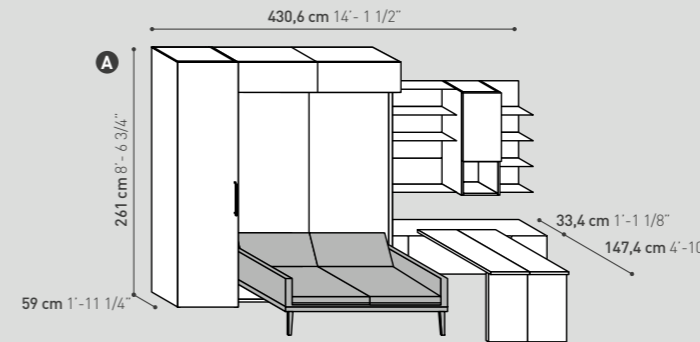

REDISENZIALE
85 m²

- 1 Block System
- 2 System 20
- 3 Twist tavolo girevole apribile
- 4 Lineup mensola
- 5 Pensili verticali e orizzontali
- 6 Flip divano
- 7 Pill pouf

- 1 Block System
- 2 System 20
- 3 Twist openable turning table
- 4 Lineup shelf
- 5 Horizontal and vertical boxes
- 6 Flip sofa
- 7 Pill pouf

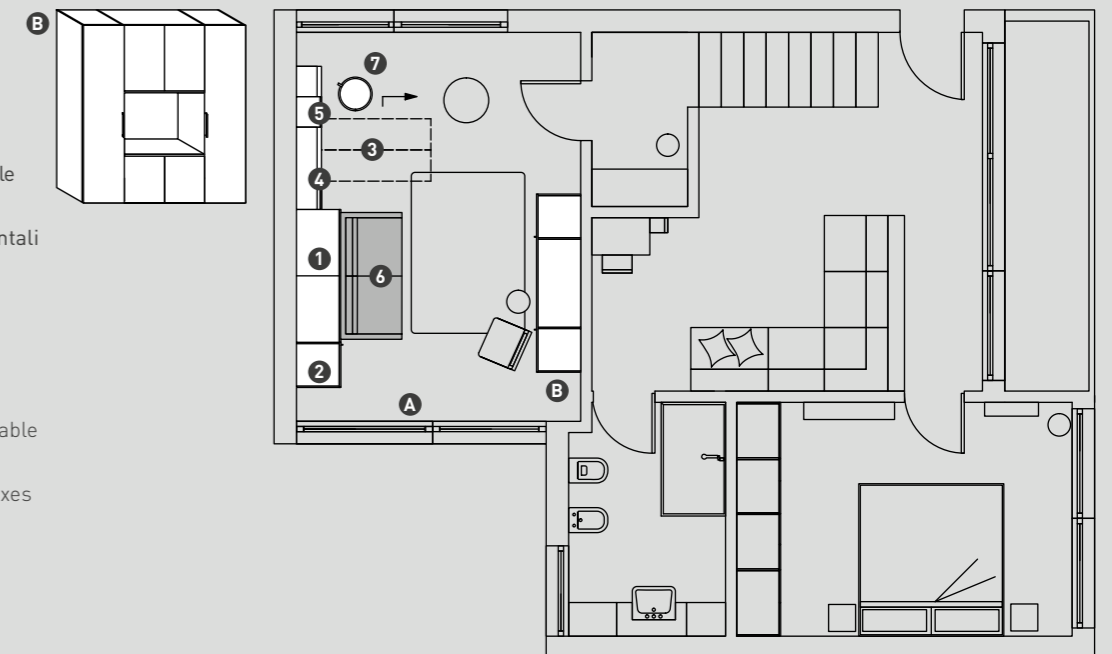

219 ON OFF

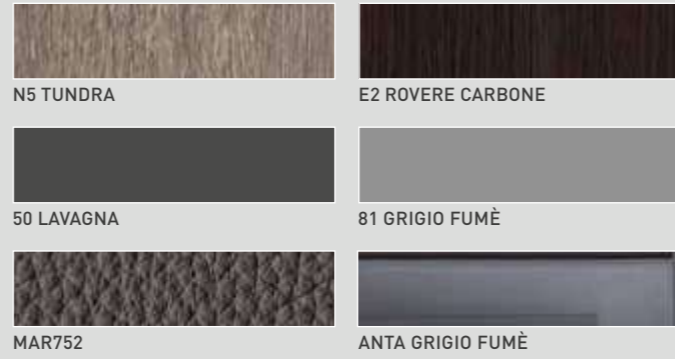

ON

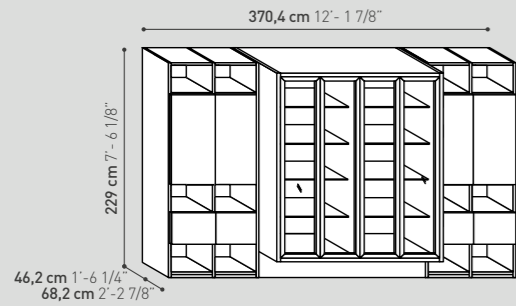

REDISENZIALE

100 m²

- 1 Alcova System
- 2 System 28
- 3 Pill Pouf

- 1 Alcova System
- 2 System 28
- 3 Pill Pouf

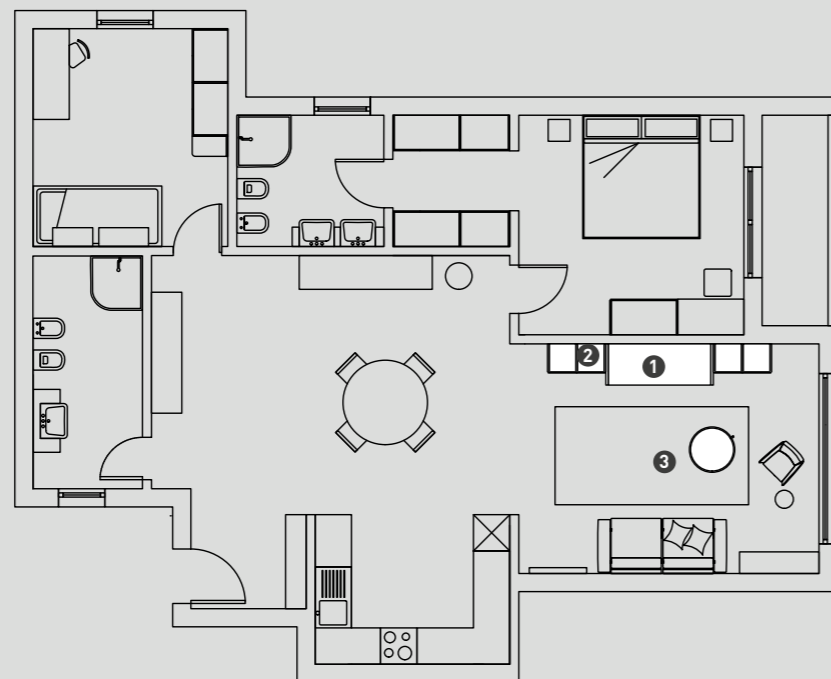

220 ON OFF

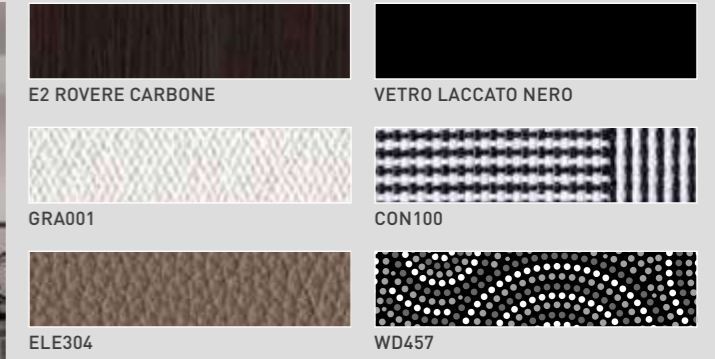

ON

OFF

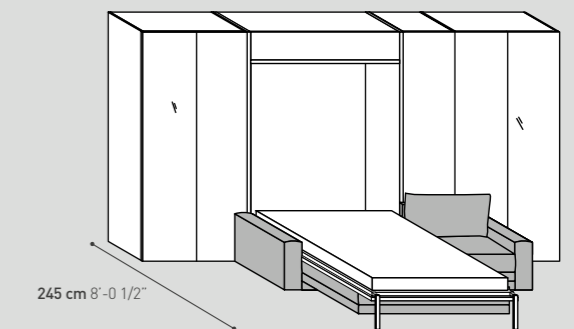
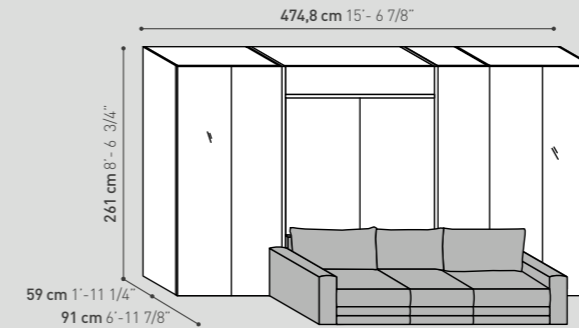

SMART HOME

107 m²

- 1 Block System
- 2 System 20
- 3 Able poltrona ribaltabile
- 4 Anta vetro laccato
- 5 On-Off divano
- 6 Pill pouf

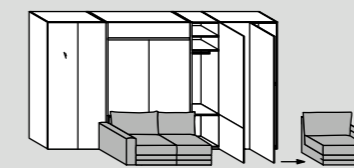

Apertura ante
Opening doors

- 1 Block System
- 2 System 20
- 3 Able flip-open armchair
- 4 Lacquered glass door
- 5 On-Off sofa
- 6 Pill pouf

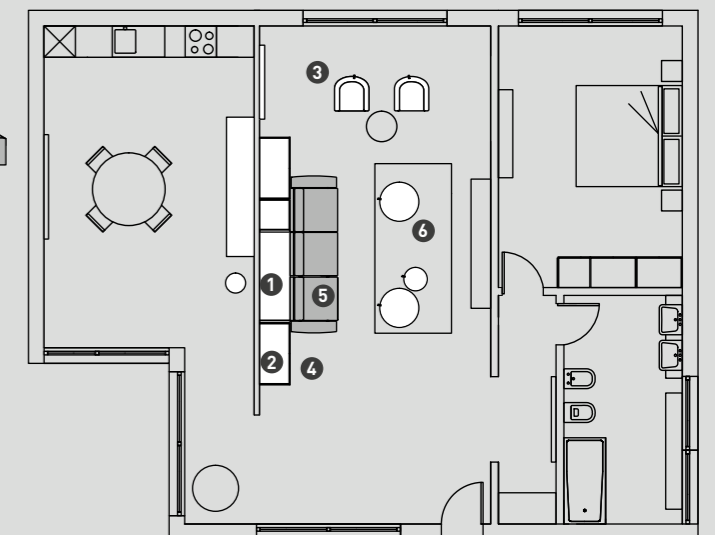

221 ON OFF

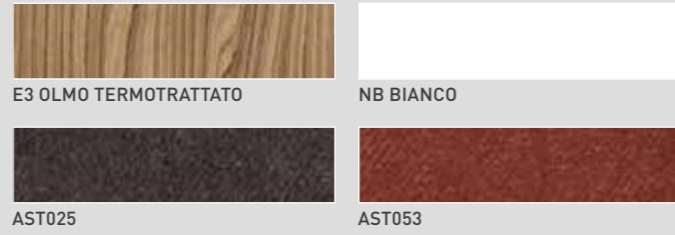

ON

OFF

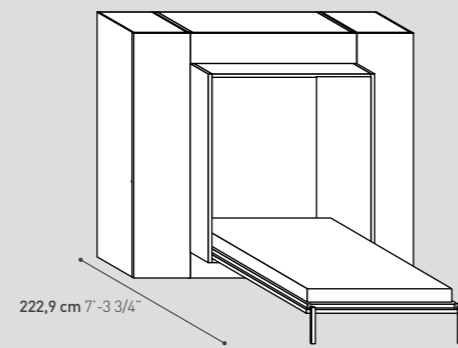
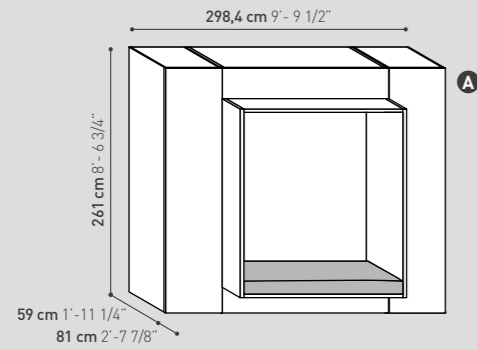

SMART HOME

85 m²

- 1 Alcova System
- 2 System 20
- 3 Magic Mirror
- 4 Pill Pouf
- 5 Poltroncina Able

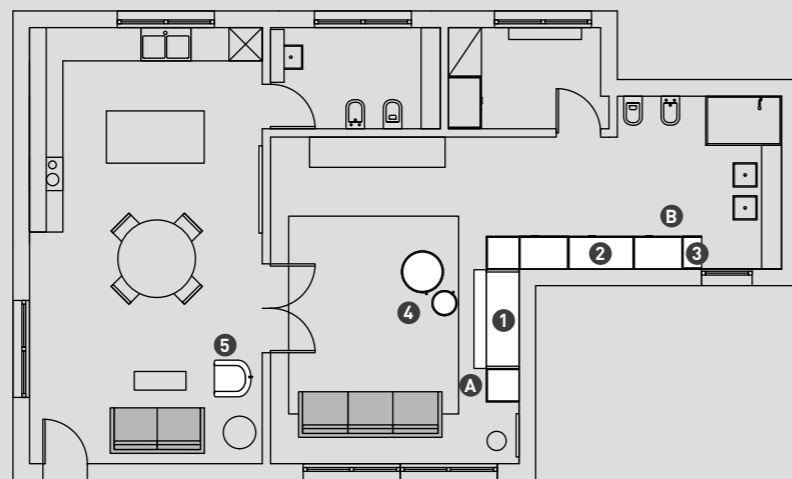
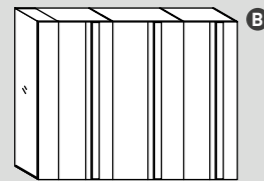

- 1 Alcova System
- 2 System 20
- 3 Magic Mirror
- 4 Pill Pouf
- 5 Armchair Able



FOCUS

ABACO BLOCK
DIVANO ON-OFF
ABACO ALCOVA
DIVANO FLIP
DIVANO FLUFFY
COMPLEMENTI

BLOCK DETAIL
ON-OFF SOFA
ALCOVA DETAIL
FLIP SOFA
FLUFFY SOFA
COMPLEMENTS

BLOCK SYSTEM

Con pochi, semplici gesti la zona giorno diventa una "camera da letto" in piena regola. È l'effetto ON-OFF, un sistema componibile che rivede il concetto di trasformabilità perché considera un nuovo modo di utilizzare lo spazio domestico. Il classico divano trasformabile, sempre un po' scomodo in quanto compromesso tra i due, lascia il posto ad un'idea sorprendentemente efficace e semplice, come accendere la luce.

In a few simple steps the living area turns into an actual bedroom. It's the "ON-OFF effect": a step change in convertible solutions, with a modular system that radically changes the residential landscape. A real freestanding sofa and a real, comfortable bed. Don't give up on comfort. Don't give up on style. As easy as turning the light on.

RETE VERTICALE VERTICAL FRAME



RETE ORIZZONTALE HORIZONTAL FRAME



FOCUS

Con un facile gesto, l'apposita maniglia sotto al cuscino di seduta consente di modificare la vostra posizione sul divano o di completare l'apertura dello stesso per permettere l'utilizzo del letto.

By simply pulling a handle underneath the seat cushion, you can slightly recline the seat or complete the full opening of the sofa to allow the bed panel to come down.



Rivestimento rete in tessuto, color grigio o corda.

Fabric covering for slatted frame, grigio or corda colour.



BLOCK SYSTEM

P / D 33,4 cm / H 229 - 261cm

Block letto matrimoniale verticale
Block vertical double bed
* L / W 169,6 cm H 229 / 261 cm P / D 33,4 cm

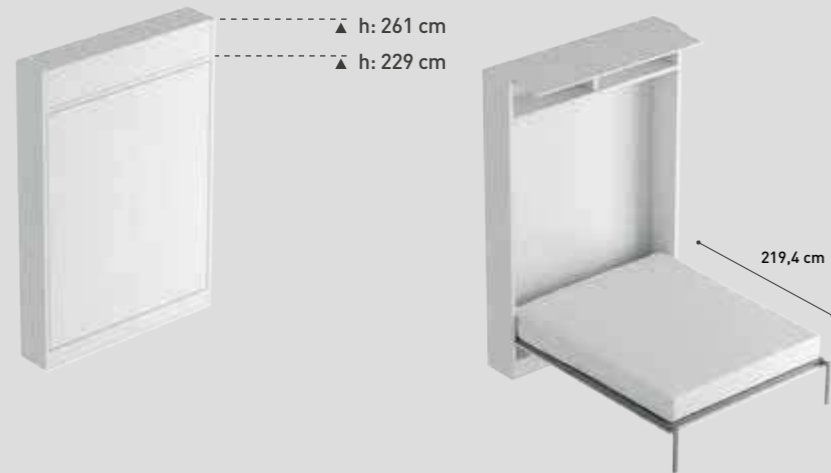

Block letto singolo verticale e piazza e mezzo
Block vertical single bed and 3/4 bed
* L / W 88 / 124,6 cm H 229 / 261 cm P / D 33,4cm



P / D 33,4 cm / H 197 - 229 - 261cm

Block letto matrimoniale orizzontale
Block horizontal double bed
* L / W 205,6 cm H 197 / 229 / 261 cm P / D 33,4 cm

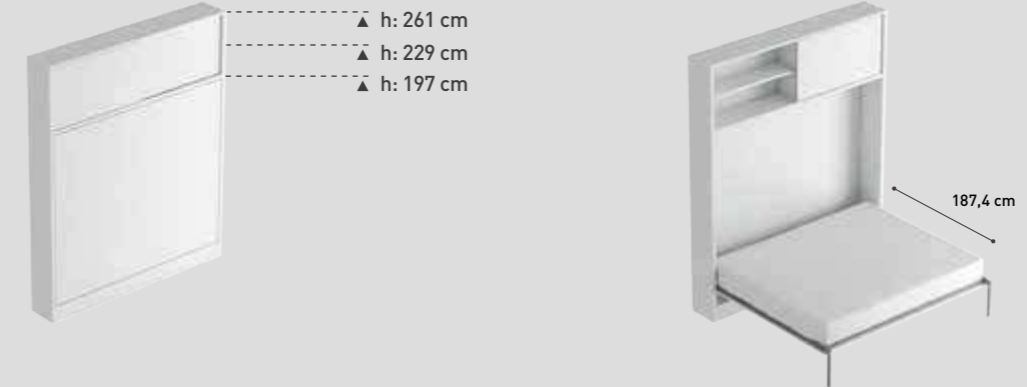

P / D 46,2 - 59 cm / H 229 - 261 cm

Block letto matrimoniale verticale
Block vertical double bed
* L / W 169,6 cm H 229 / 261 cm P / D 46,2 / 59 cm

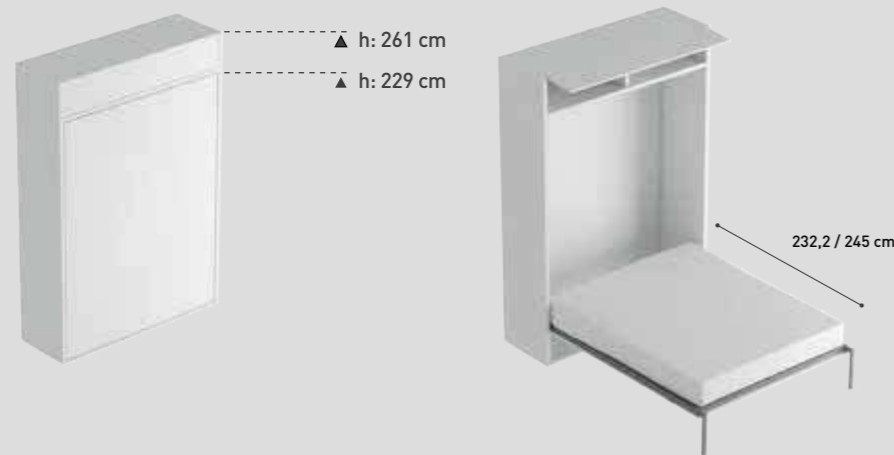

Block letto singolo verticale e piazza e mezzo
Block vertical single bed and 3/4 bed
* L / W 88 / 124,6 cm H 229 / 261 cm P / D 46,2 / 59cm



P / D 46,2 - 59 cm / H 197 - 229 - 261cm

Block letto matrimoniale orizzontale
Block horizontal double bed
L / W 205,6 cm H 197 / 229 / 261 cm P / D 46,2 / 59 cm

Testata opzionale
Optional headboard



P / D 33,4 - 46,2 - 59 cm / H 103,8 - 135,8 cm

Block orizzontale letto singolo e piazza e mezzo
Block horizontal single and 3/4 bed
L / W 205,6 cm H 103,8 / 135,8 cm P / D 33,4 / 46,2 / 59cm

Testata opzionale
Optional headboard

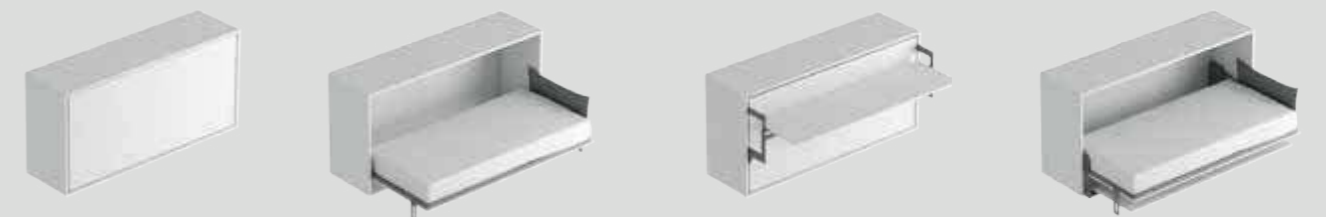

Materasso Mattress
MATRIMONIALE DOUBLE L / W 155 / 160 cm A / H 16 / 20 cm P / D 195 / 200 cm
PIAZZA E MEZZO 3/4 BED L / W 115 cm A / H 16 / 20 cm P / D 195 cm
SINGOLO SINGLE L / W 80 cm A / H 16 / 20 cm P / D 195 cm

* Per tutte le misure in larghezza aggiungere spessore dei fianchi.
For all width sizes, please, add the sides thickness.

Materasso Mattress
MATRIMONIALE DOUBLE L / W 195 / 200 cm A / H 16 / 20 cm P / D 165 / 170 cm
PIAZZA E MEZZO 3/4 BED L / W 195 cm A / H 16 / 20 cm P / D 110 / 115 cm
SINGOLO SINGLE L / W 195 cm A / H 16 / 20 cm P / D 80 / 85 cm

Ingombro da aperto Size when open
108 cm (min) / 165,6 cm (max)

ON-OFF SOFA

Suggerimenti di divani con sistema *recliner* da utilizzare con i letti a ribalta matrimoniali.
A few suggestions of sofas with *recliner* system, to be matched with folding beds.

...e altri con divani fissi da collocare in libertà in qualsiasi spazio.
...and other sectional sofas to be used as regular sofas in any environment.

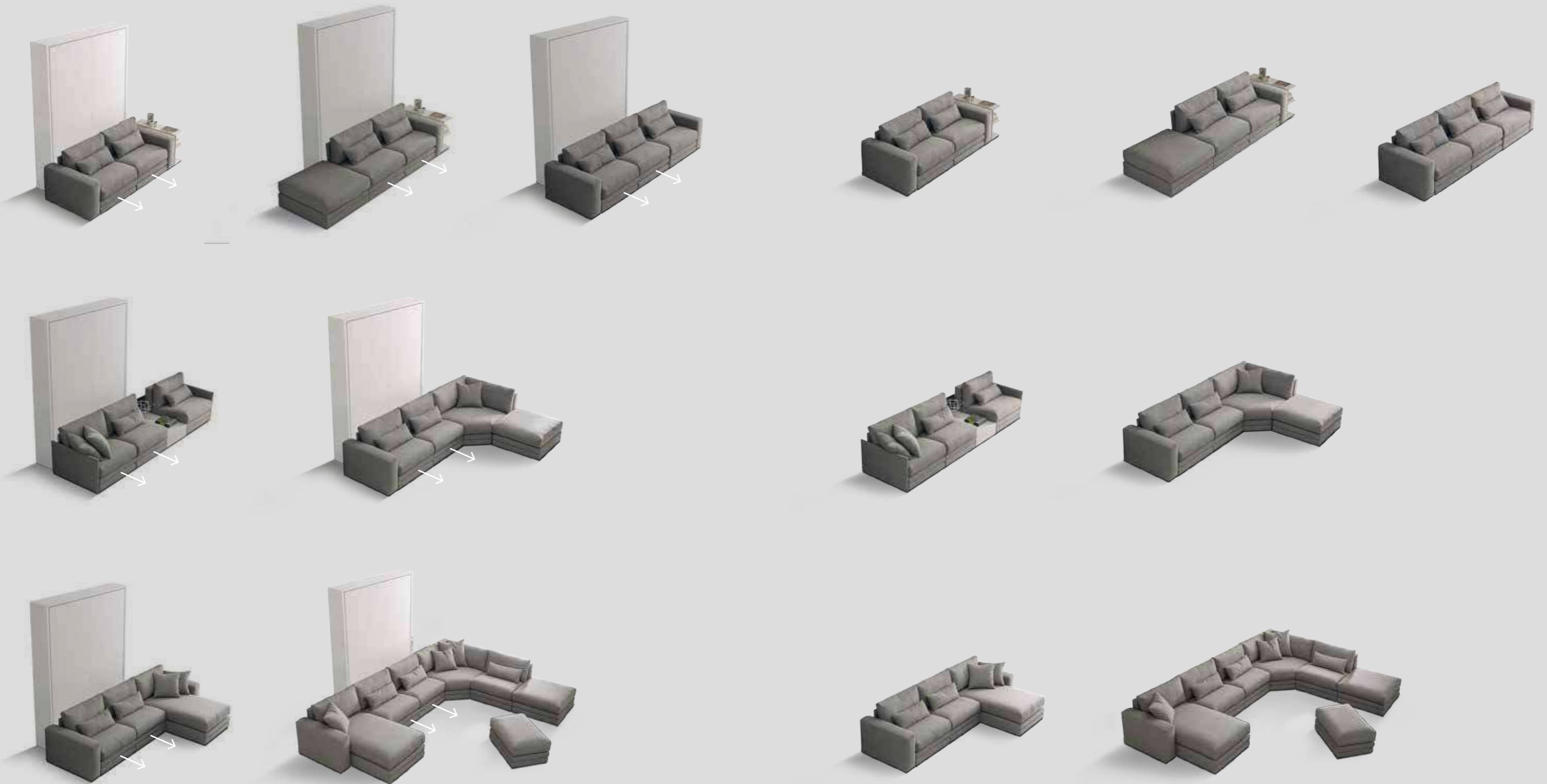

ON-OFF SOFA

BRACCIOLI
ARMRESTS



BRACCIOLO CLASSICO
CLASSICAL ARMREST



PROFILO IN LEGNO
WOODEN COVER-UP ELEMENT



BRACCIOLO LARGO
LARGE ARMREST



BRACCIOLO LARGO CON CONTENITORE
FLIP-UP LARGE ARMREST



BRACCIOLO STRETTO
NARROW ARMREST



SOUND BRACCIOLO
SOUND ARMREST

Il progetto ON-OFF è stato completato con alcuni elementi componibili, che racchiudono una serie di pratici e utilissimi vani, o elementi funzionali aggiuntivi che possono essere richiesti come optional.

ON-OFF features are completed by a few modular elements, that hide an array of practical and useful containers, or further functional additions upon request.



Il bracciolo largo viene corredato da un vano interno, dove possono venire riposti i guanciali del letto, o ciò che più si desidera. A ulteriore completamento, nel suo vano interno può trovare alloggio anche un tavolino accessorio, che, inserito nell'apposita guida, funge come pratico piano di appoggio per lavoro, lettura o qualsiasi necessità.

The large armrest is in fact a container, that can lodge pillows or any other item. A lift-up tablet is a further completing element: once inserted in the runner, it works as a small workstation or reading top, or anything else.



Con l'idea di creare spazio ulteriore all'interno della propria abitazione, il pouf fisso, già presente nell'insieme degli elementi componibili, si può trasformare in un altro comodo contenitore per coperte, guanciali, libri, etc...

To further enhance the space optimization, the most traditional pouf, can become, once again, a useful container for blankets, pillows, books, etc...



ELEMENTI RECLINABILI
RECLINING ELEMENTS

Poltrona 1 posto
1 seater armchair



Divano 1 posto e mezzo
1 and 1/2 seater sofa



Divano 2 posti
2 seater sofa



ELEMENTI FISSI componibili in autonomia dal mobile
MODULAR FREESTANDING ELEMENTS

Seduta fissa
Fixed unit



Chaise longue
Chaise longue



Elemento angolare
Corner unit



Serie di pouf in varie dimensioni fissi o apribili
Fixed or flip-up pouf in different sizes

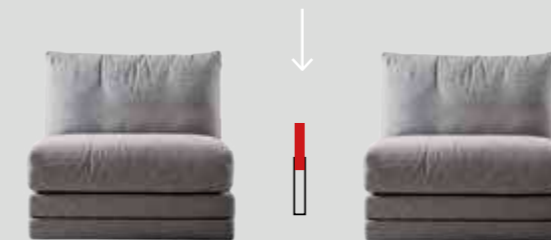

Gli elementi di giunzione tra i vari componenti del divano sono facilmente posizionabili e riposizionabili, consentendo anche ai non addetti ai lavori di poter modificare l'aspetto e la forma del proprio divano garantendo sempre una eccezionale stabilità.

The connecting elements between the various components of the sofa are easy to be positioned, allowing even laymen to change the aspect and the shape of the sofa always guaranteeing exceptional stability.



Posteriormente agli elementi con movimento, si trova un'asta mobile che rappresenta l'unico vincolo fra divano e mobile letto. Inserendo l'asta fra spalla e anta (senza nessun fissaggio) si consente al divano di rimanere sempre perfettamente allineato rispetto alla discesa del letto. Con l'asta abbassata, nascosta fra un elemento e l'altro, il divano torna a vivere in completa autonomia, separato dal mobile.

Behind the elements with reclining mechanism there is a collapsible lever. This represents the only connection between the sofa and the bed block. Once you position the lever parallel to the floor, it sticks out of the back of the sofa to be inserted, without any fixing, in the slot between the side and the door of the bed container. This system allows the sofa to always stay perfectly aligned with the bed structure, thus avoiding misplacements that would preclude a normal functioning of the mechanism. By collapsing the bar, the sofa gets back to being a totally freestanding element.

SISTEMA RECLINER RECLINER SYSTEM

Il divano ON-OFF è caratterizzato da un movimento meccanico nato appositamente per lui; studiato, realizzato e brevettato da ATL Group spa, consente l'avanzamento del cuscino di seduta e contemporaneamente l'inclinazione del cuscino di schienale, fino alla totale posizione orizzontale di quest'ultimo. Il meccanismo così costituito, una volta aperto completamente, offre la possibilità di discesa del Letto. Il meccanismo può essere realizzato sia per utilizzo manuale, con un semplice movimento di apertura a scorrimento che consente anche di utilizzare una posizione intermedia di recliner, che con motorizzazione comandata direttamente da un telecomando. Quest'ultima versione consente un posizionamento millimetrico delle varie inclinazioni dello schienale, dando la possibilità di scegliere la personale miglior inclinazione di seduta per il momento che si sta vivendo.

Esistono diversi tipi di apertura e chiusura con il sistema motorizzato:

- apertura/chiusura solo delle sedute divano
- apertura /chiusura solo del contenitore letto
- apertura /chiusura combinata del divano e contenitore letto contemporaneamente

Anche con movimento motorizzato.
Sistema coperto da brevetto internazionale.

The ON-OFF sofa is characterized by an especially designed collapsible mechanism; studied, carried out and patented by ATL Group. It allows the seating cushion to move forward and the back cushion to collapse, until the sofa becomes completely flat, before the bed panel is pulled down. The mechanism can be manually operated through a sliding system with an intermediate recliner-position, or electrically, through a remote control. The latter allows a variable positioning of both the back and the seat and thus a choice of the best posture for you.

There are different kinds of opening/closing with the remote control:

- opening/closing of the sofa seats only
- opening/closing of the bed cabinet only
- combi opening/closing of both sofa and bed cabinet together

Also with remote control electro-mechanism.
System covered by international patent.



SISTEMA MOTORIZZATO COMBI COMBI MOTOR SYSTEM



Apertura/chiusura seduta sinistra divano
Opening/closing left seat of the sofa



Apertura/chiusura seduta destra divano
Opening/closing right seat of the sofa



Apertura combinata letto/divano
Combi opening of both bed and sofa



Chiusura combinata letto/divano
Combi closing of both bed and sofa

DUE TIPOLOGIE DI TESTATE IMBOTTITE
TWO TYPES OF UPHOLSTERED HEADBOARDS

ON-OFF propone due tipi di testate per il letto nelle versioni matrimoniale e piazza e mezza e singolo con cuscino imbottito o con cuscino piatto, a seconda della profondità del mobile scelto.

ON-OFF has two types of headboards for the double, the ¾ and the single bed, with a padded cushion or a flat cushion, according to the depth of the cabinet.



240 ON OFF

VANO CONTENITORE PER CUSCINI INTERNO TESTATA
HEADBOARD PILLOW CASE

Nella profondità cm 59 è previsto su richiesta un vano retrotestata in cui alloggiare i cuscini della testata imbottita o i vostri guanciali da notte.

In 59 cm-deep cabinets, we can provide, upon request, a headboard pillow compartment to hide the headboard cushions or the pillows.

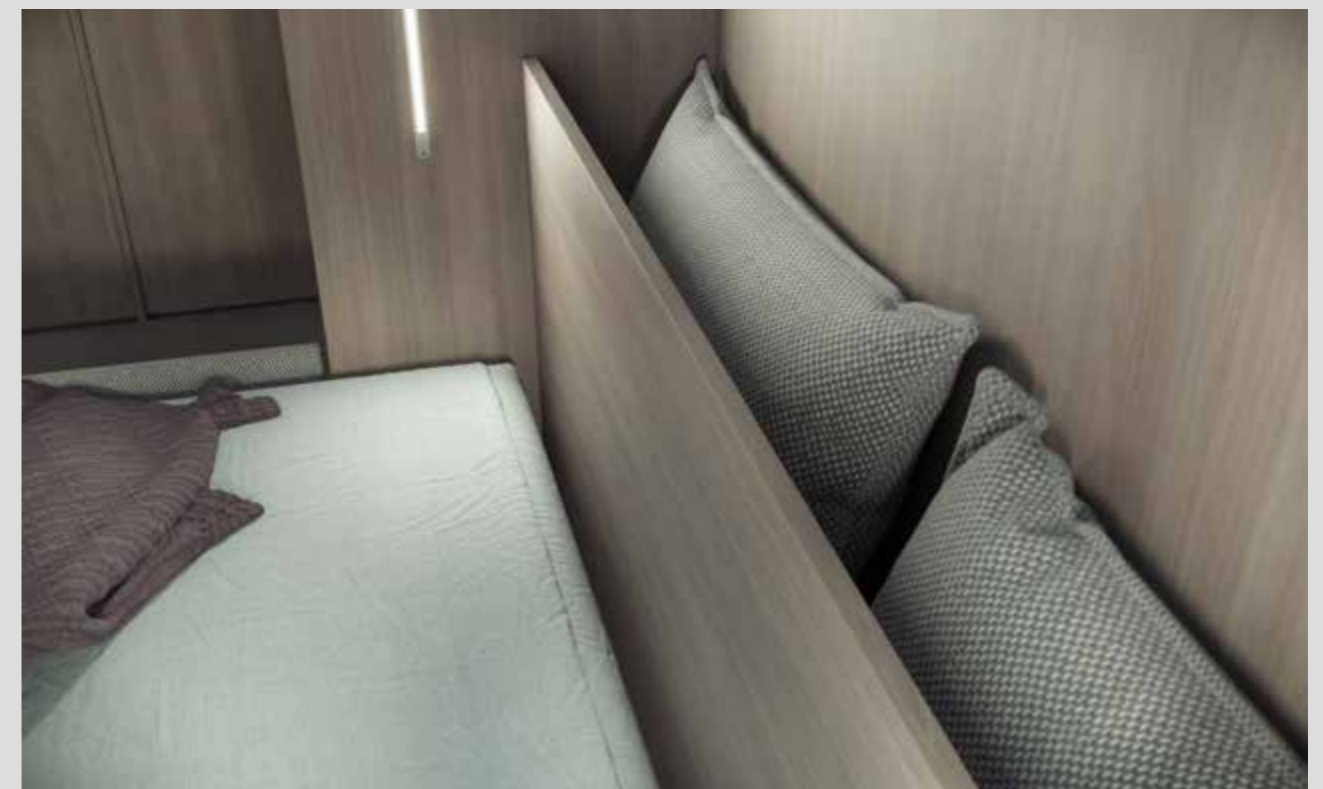

241 ON OFF

ALCOVA SYSTEM

Design by Simone Cagnazzo

Sintesi ideale tra seduta e letto, Alcova System offre soluzioni flessibili per risolvere problemi di spazio all'insegna di un codice di eleganza contemporaneo. Un nuovo concept dell'abitare che svela quanto sia agevole convertire il salotto in camera da letto non con il classico trasformabile ma con una particolarità, la cornice a sbalzo, che crea una seduta confortevole e funzionale, per sfruttare al meglio lo spazio. Con pochi gesti diventa un letto matrimoniale e, in modo altrettanto semplice, ritorna alla configurazione originaria. Ne discende un progetto ampiamente declinato, utilizzabile sia in ambienti contract, che privati. Oltre la versione seduta e letto a scomparsa, può essere configurata in varie soluzioni d'arredo: è possibile configurarla nella versione seduta e schienale con armadiatura, dotata di vari accessori interni, armadio con ante in vetro a soffietto e libreria a giorno con e senza seduta. È disponibile nella vasta gamma di finiture in essenza, nobilitato e laccato della collezione TUMIDEI.

The ideal union between seat and bed, Alcova System offers flexible solutions to solve space problems in the pursuit of a contemporary elegance code. A new living concept which makes easier the transformation of the living area into a bedroom without the traditional murphy bed, but with a detail, a sticking out frame, which creates a comfortable and functional seat, in the aim of saving space at best. With a few steps, it turns into a double bed and, in the same easy way, it comes back to the previous configuration. The result is a multifaceted project which can be used in both home and contract environment. Besides the seat and murphy bed version, there are further design configurations: it is possible to set it up in the same seat version but with wardrobes behind, supplied with several internal accessories, or with hinged or folding glass doors wardrobes or open bookcase, with or without seat. It is available in the whole range of finishes, veneer, melamine and lacquered of the TUMIDEI collection.

RETE VERTICALE MATRIMONIALE DOUBLE VERTICAL FRAME



RETE ORIZZONTALE MATRIMONIALE DOUBLE HORIZONTAL FRAME



ALCOVA VERTICALE L / W 177,6 cm

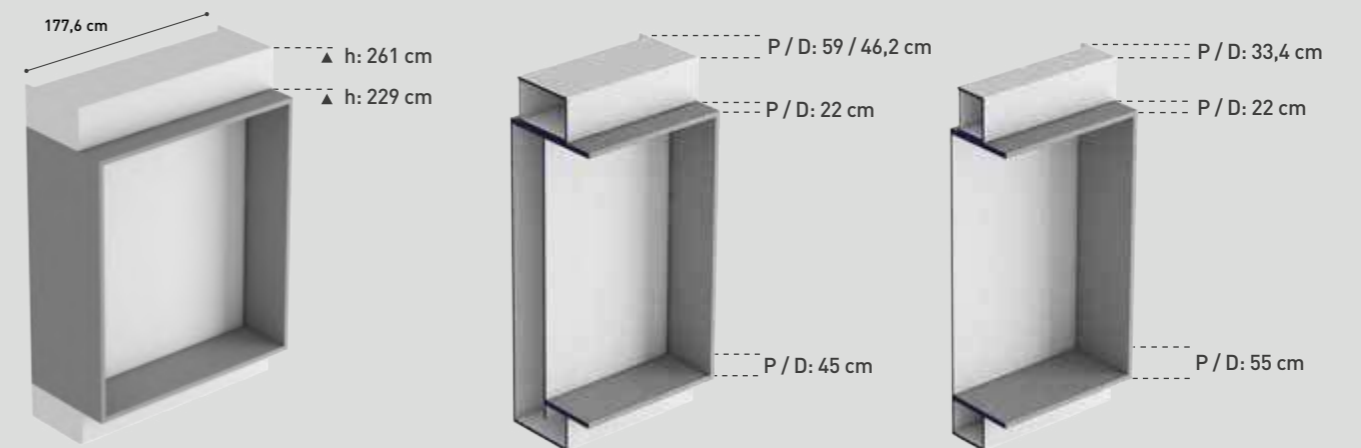

ALCOVA ORIZZONTALE L / W 213,6 cm

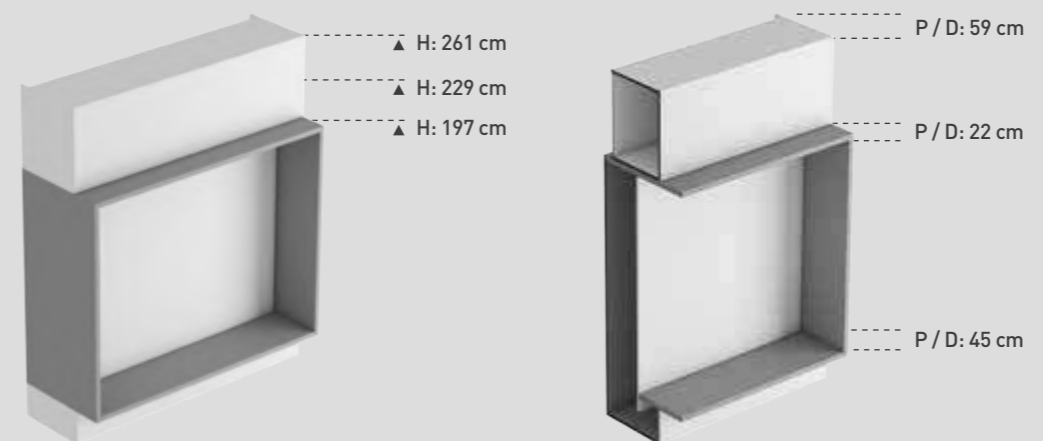

ALCOVA LIGHT L / W 177,6 cm

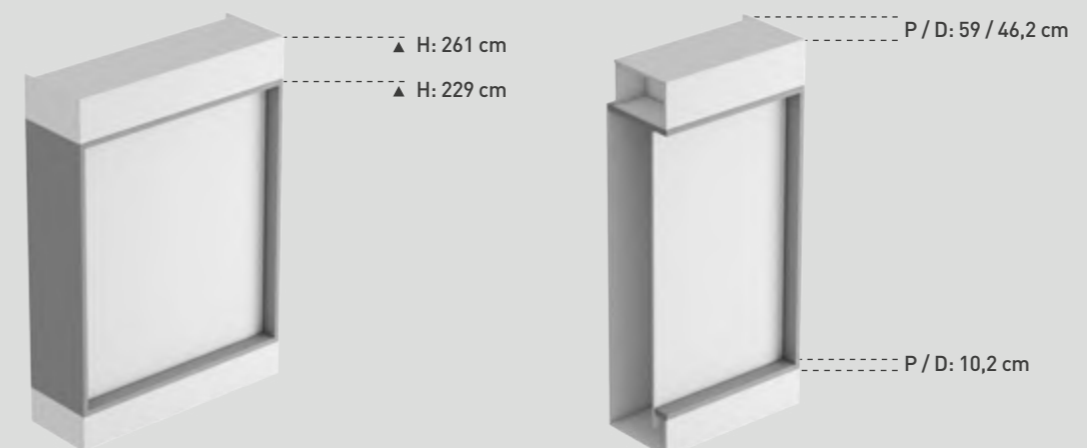

ALCOVA SYSTEM

ESEMPI DI COMPOSIZIONI
EXAMPLES OF CONFIGURATION

ESEMPI DI COMPOSIZIONI
EXAMPLES OF CONFIGURATION

P / D 33,4 cm / H 229-261 cm

Alcova con seduta Alcova with seat:
L / W 177,6 cm A / H 229 / 261 cm P / D 55,4 cm

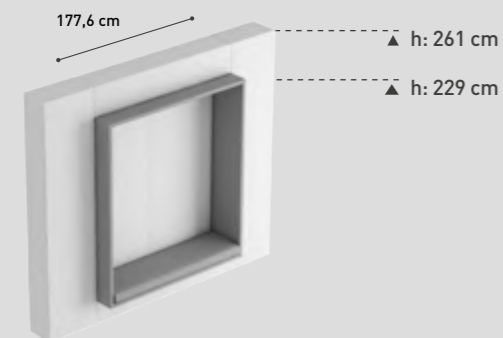

Cuscino Seduta Seat Cushion:
L / W 169 cm A / H 10 cm P / D 55 cm

Da affiancare a colonne P 33,4 cm
To combine with columns D 33,4 cm

Alcova con libreria Alcova with bookcase
L / W 177,6 cm A / H 229 / 261 cm P / D 55,4 cm



Alcova con seduta e libreria Alcova with seat and bookcase
L / W 177,6 cm A / H 229 / 261 cm P / D 55,4 cm



Alcova con ante a soffietto in vetro
Alcova with folding glass doors
L / W 177,6 cm A / H 229 / 261 cm P / D 55,4 cm



Con ripiani interni in vetro / legno
With internal glass / wood shelves

Alcova con ante a soffietto in vetro
Alcova with folding glass doors
L / W 177,6 cm A / H 229 / 261 cm P / D 55,4 cm



Con ripiani interni e tubi appendiabiti
With internal shelves and hanging rails

P / D 59 cm / H 229-261 cm

Alcova con seduta e letto verticale Alcova with seat and vertical bed
L / W 177,6 cm A / H 229 / 261 cm P / D 81 cm

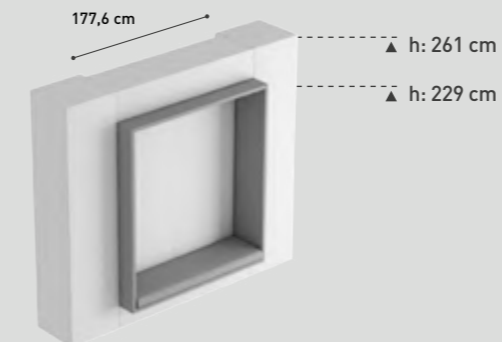

Cuscino Seduta Seat Cushion:
L / W 169 cm A / H 10 cm P / D 45 cm

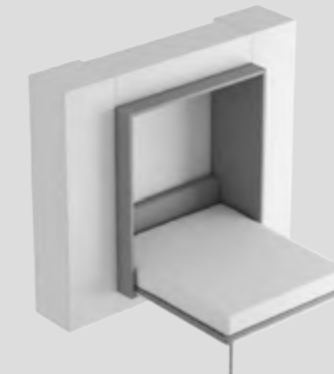

Materasso Mattress
L / W 155 / 160 cm A / H 20 cm P / D 195 / 200 cm
Profondità aperto Depth when open 222,9 cm

P / D 46,2 / 59 cm / H 229-261 cm

Alcova con seduta e 4 ante Alcova with seat and 4 doors
L / W 177,6 cm A / H 229 / 261 cm P / D 68,2 / 81 cm

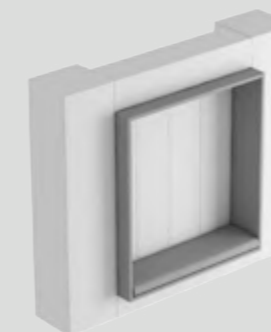

Cuscino Seduta Seat Cushion:
L / W 169 cm H 10 cm P / D 45 cm



Con ripiani
With shelves



Con pomoli
With knobs

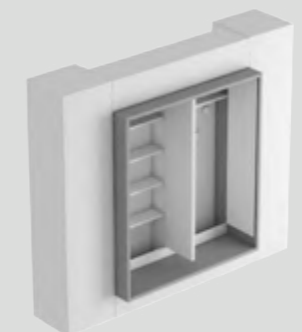

Con ripiani + pomoli
With shelves + knobs

Attrezzatura interna Internal equipment

Alcova con ante a soffietto in vetro
Alcova with folding glass doors
L / W 177,6 cm A / H 229 / 261 cm P / D 68,2 - 81 cm

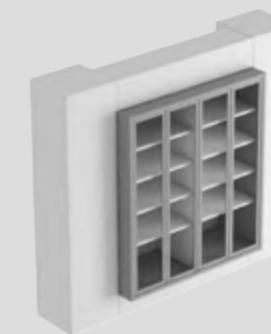

Con ripiani interni in vetro / legno
With internal glass / wood shelves

Alcova con ante a soffietto in vetro
Alcova with folding glass doors
L / W 177,6 cm A / H 229 / 261 cm P / D 68,2 - 81 cm



Con ripiani interni e tubi appendiabiti
With internal shelves and hanging rails

ALCOVA SYSTEM

ESEMPI DI COMPOSIZIONI
EXAMPLES OF CONFIGURATION

P / D 59 cm

Alcova con seduta e letto orizzontale Alcova with seat and horizontal bed
L / W 213,6 cm A / H 197 cm P / D 81 cm

Materasso Mattress
L / W 165 / 170 cm A / H 20 cm P / D 195 / 200 cm
Profondità aperto Depth when open
190,9 cm

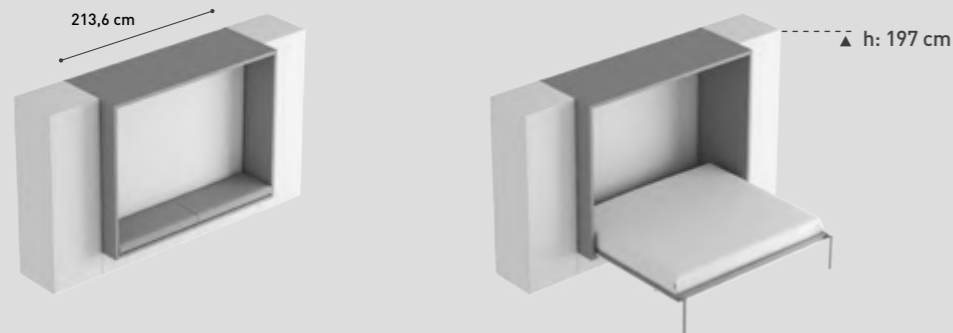

Alcova con seduta e letto orizzontale Alcova with seat and horizontal bed
L / W 213,6 cm A / H 229 cm P / D 81 cm

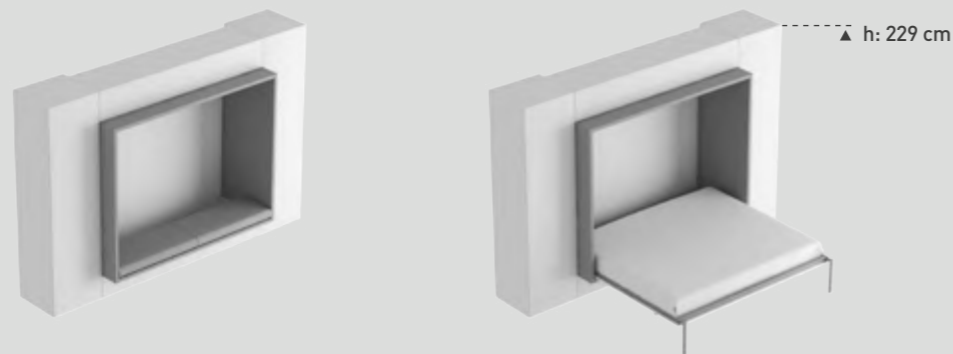

Alcova con seduta e letto orizzontale Alcova with seat and horizontal bed
L / W 213,6 cm A / H 261 cm P / D 81 cm

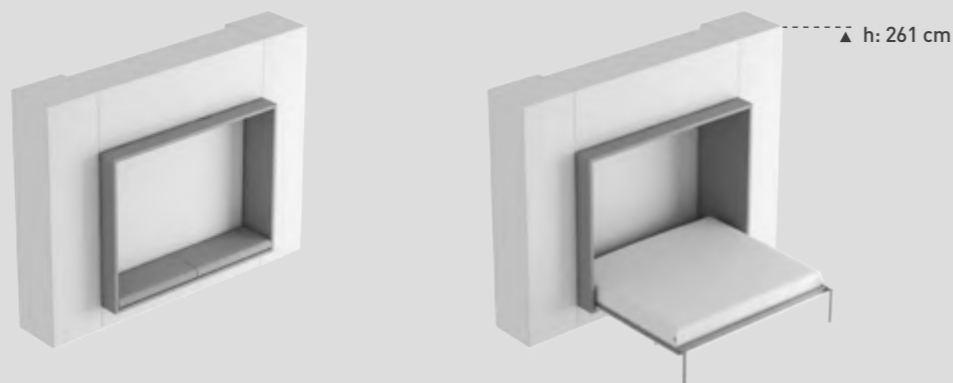

2 cuscini seduta 2 seat cushions
L / W 102,5 cm A / H 10 cm P / D 45 cm

ALCOVA LIGHT

ESEMPI DI COMPOSIZIONI
EXAMPLES OF CONFIGURATION

P / D 46,2 - 59 cm / H 229-261 cm

Alcova Light con letto Alcova Light with bed
L / W 177,6 cm A / H 229 / 261 cm P / D 46,2 / 59 cm

Materasso Mattress
L / W 155 / 160 cm A / H 20 cm P / D 195 / 200 cm
Profondità aperto Depth when open
222,9 / 235,7 cm

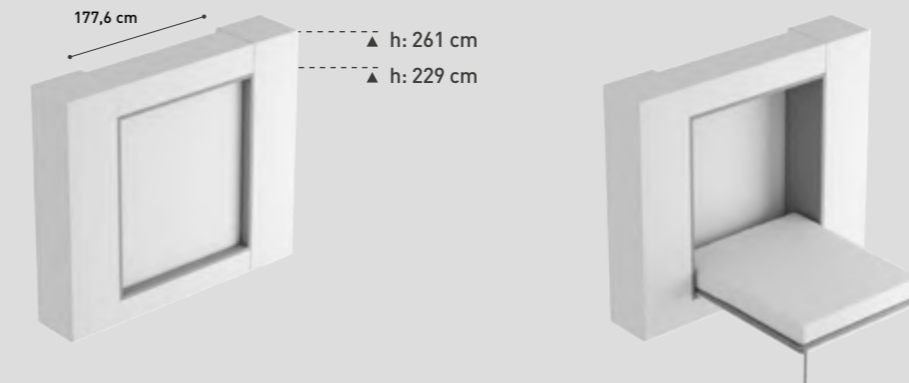

ALCOVA LIGHT + FLIP

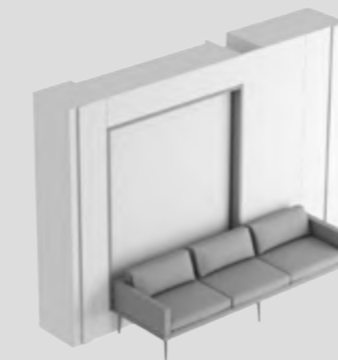

ALCOVA LIGHT + FLUFFY

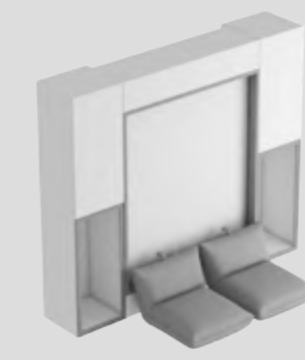

MANIGLIA ALCOVA
ALCOVA HANDLE
L / W 2,7 cm A / H 4 cm



PUSH PULL

Alcova Light è caratterizzata da una cornice rientrante ad effetto quadro, dotata di una luce integrata nella parte superiore interna. Permette vari tipi di personalizzazioni, con finiture e decorazioni grafiche della collezione TUMIDEI. È disponibile nella vasta gamma di finiture in essenza, nobilitato e laccato della collezione TUMIDEI.

Alcova Light is characterized by a recessing frame with painting effect, supplied with integrated light in the upper internal part. It allows different kinds of customizations, using the finishes and the graphic decorations from TUMIDEI collection. It is available in the whole range of finishes, veneer, melamine and lacquered of the TUMIDEI collection.

FLIP SOFA

Design Simone Cagnazzo

Flip è una collezione di divani rigorosi, ispirati ad un design puro. Il sistema di imbottiti Flip rivoluziona il concetto di divano che diventa modulare e dimezzabile nella sua altezza totale. Gli schienali del divano e i cuscini delle sedute sono completamente abbattibili, e tutta la struttura superiore reclinabile, in questo modo il divano può essere posto frontalmente al Block System e Alcova Light.

FLIP is a collection of austere sofas, inspired by pure design. The FLIP system of upholstered elements transforms the concept of sofa which becomes modular and splittable along its total height. The backs of the sofa and the seat cushions are completely flippable and all the upper structure is reclining. In this way, the sofa can be placed in front of the Block System and Alcova Light.



Lo schienale del divano Flip è sdoppiabile in altezza, per fungere da comodo poggia testa.
The back of the Flip sofa is splittable in its height in order to work as practical headrest.

FOCUS

Il divano è caratterizzato dal dettaglio della maniglia in pelle, che permette la trasformazione e l'appoggio a terra dello schienale.
One of the main features is the leather handle, which enables to transform the sofa by resting the back on.

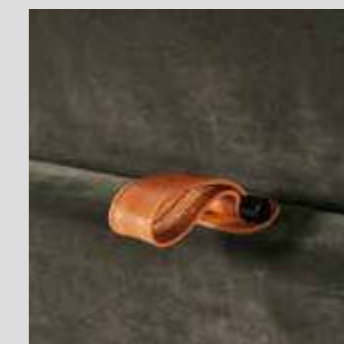

Piede versione legno in rovere tinto nero carbone.
Version with feet in oak wood painted in carbone finish.



Piede versione metallo taglio laser e verniciato in smalto epossidico.
Version with metal feet, laser-cut and epoxy-lacquered.



Il divano Flip completamente abbattibile permette l'apertura orizzontale e verticale dei letti matrimoniali orizzontali e verticali dei sistemi Block e Alcova.

The Flip sofa, once flip-opened, allows the opening of the horizontal and vertical beds of Block System and Alcova Light.

FLIP SOFA

Design Simone Cagnazzo

Un divano unico, scomposto e riconfigurato si può trasformare in poltrona, love seat, divano due posti e tre posti, con penisola, piano o vassoio laterale. Le gambe sottili, contribuiscono a rendere l'imbottito molto leggero e possono essere in metallo taglio laser e verniciato in smalto epossidico, oppure in rovere tinto nero carbone.

A unique sofa, modular and customizable, which turns into an armchair, a love seat, a two or three seater sofa, with peninsula, lateral top or plate. The fine legs give to the sofa a very light aspect, they can be in laser-cut and epoxy-lacquered metal or in lacquered oak.

FLIP POLTRONA / ARMCHAIR
poltrona 1 posto 1 seater armchair
L / W 88 cm H 70 cm P / D 82 cm



FLIP LOVE SEAT
Love seat 1 posto e mezzo Love seat 1 and 1/2 seater
L / W 124 cm H 70 cm P / D 82 cm



FLIP SOFA
Divano 2 posti 2 seater sofa
L / W 169 cm H 70 cm P / D 82 cm



FLIP SOFA
Divano 3 posti 3 seater sofa
L / W 258 cm H 70 cm P / D 82 cm



FLIP SOFA
Divano 2 posti e penisola laterale 2 seater sofa and peninsula
L / W 250 cm H 70 cm P / D 82 cm



FLIP SOFA
Divano 2 posti e piano in legno 2 seater sofa and wooden top
L / W 250 cm H 70 cm P / D 82 cm



FLIP SOFA
Divano 2 posti e vassoio in legno 2 seater sofa and wooden plate
L / W 250 cm H 70 cm P / D 82 cm



Piano o vassoio laterale.
Side top or plate



FLUFFY SOFA

Design Simone Cagnazzo

Solare e morbida presenza per FLUFFY.

Il perfetto incontro tra il comfort e colore, FLUFFY è un sistema di divani flessibili studiati per il totale relax. Disponibili in due differenti larghezze, si contraddistinguono per il particolare meccanismo interno che li rende completamente reclinabili, trasformandoli in sacchi/pouf morbidi e confortevoli.

Sunny and soft presence for FLUFFY. The perfect match between comfort and color, FLUFFY is a flexible sofas system designed for the total relax. Available in two different sizes, they are characterized by a special internal mechanism which makes them completely reclining and turns them into soft and comfortable poufs.



FLUFFY SMALL



L / W 80 cm H 60 cm P / D 105 cm



L / W 80 cm H 30 cm P / D 120 cm

FOCUS

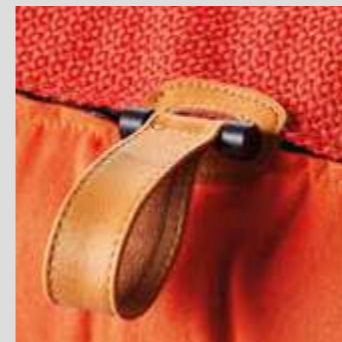

Il FLUFFY è caratterizzato dal dettaglio della maniglia in pelle, che permette una facile presa per reclinare lo schienale.

One of the main features of FLUFFY is the leather handle, which enables an easy grip to recline the back.

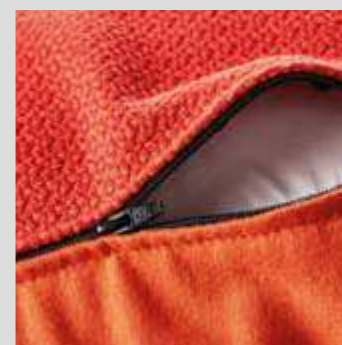

Fluffy è sfoderabile e le diverse fodere sono tra loro intercambiabili.

Fluffy is unlining and the different covers are interchangeable.



FLUFFY LARGE



L / W 115 cm H 60 cm P / D 105 cm



L / W 115 cm H 30 cm P / D 120 cm

TWICE SYSTEM

Design Simone Cagnazzo

Il concetto di TWICE permette la creazione di contenitori unici, free-standing, o ancorati a parete, con elementi pensili o a terra. Attraverso lo scorrimento del piano superiore a ponte, si crea un piano scrittoio che, sdoppiandosi a libro, si trasforma a sua volta in un pratico e originale tavolo da pranzo. Il sistema TWICE può essere personalizzato dando la possibilità di avere pezzi decorativi in tonalità oppure in contrasto, secondo dove sono sistemati, permettendo di creare un mobile che è grafico o discreto, secondo le situazioni. Il tavolo può avere finitura in essenza, nobilitato o laccato, gli elementi a terra hanno finitura in essenza, nobilitato, laccato o anche ante in vetro, mentre gli elementi pensili sono solo in finitura di essenza o laccato, oltre alle ante in vetro.

The TWICE concept leads the creation of unique, free-standing or hanging boxes. The sliding of the upper top creates a desk which, once opened like a book, can be converted into a practical and original dining table. The TWICE system can be customized by having decorative items, matching tones or in contrast, in order to create a piece of furniture which can be graphic or sober, depending on the situations. The table can be in wood, melamine or lacquered finish. In addition to these finishes, floor units can also have glass doors, whereas hanging units can be in wood or lacquered finish only, with the chance of adding glass doors.

TWICE SYSTEM CON ELEMENTO A TERRA TWICE SYSTEM WITH FLOOR ELEMENT



L / W 186 cm H 78,8 cm P / D 45,7



L / W 165 cm H 68,3 cm P / D 46,2 cm



L / W cm 186 H 76 cm P / D 91,5 cm

TWICE SYSTEM CON ELEMENTO SOSPESO TWICE SYSTEM WITH HANGING ELEMENT



L / W 186 cm H 78,8 cm P / D 45,7



L / W 165 cm H 40,8 cm P / D 43,9 cm



L / W 186 cm H 76 cm P / D 91,5 cm

ESEMPI DI COMPOSIZIONE EXAMPLES OF CONFIGURATION

TWICE SYSTEM CON ELEMENTO A TERRA TWICE SYSTEM WITH FLOOR ELEMENT media versione sospesa + consolle a terra sdoppiabile console open version + console floor version splittable



L / W 186 cm H 78,8 cm P / D 45,7 / 91,5 cm

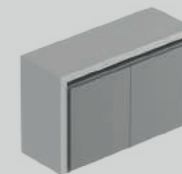

L / W 131 cm H 78,8 cm P / D 45,7 / 91,5 cm

TWICE SYSTEM CON ELEMENTO SOSPESO TWICE SYSTEM WITH FLOOR ELEMENT H 40,8 cm

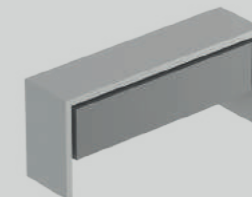

L / W 186 cm H 78,8 cm P / D 45,7 / 91,5 cm

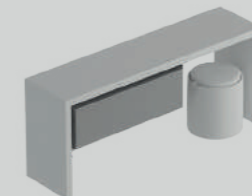

L / W 186 cm H 78,8 cm P / D 45,7 / 91,5 cm

TWICE SYSTEM CON ELEMENTI SOSPESI TWICE SYSTEM WITH HANGING ELEMENT H 55 cm

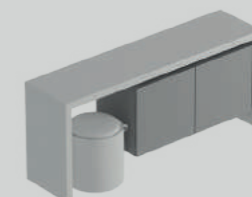

L / W 186 cm H 78,8 cm P / D 45,7 / 91,5 cm

FOCUS

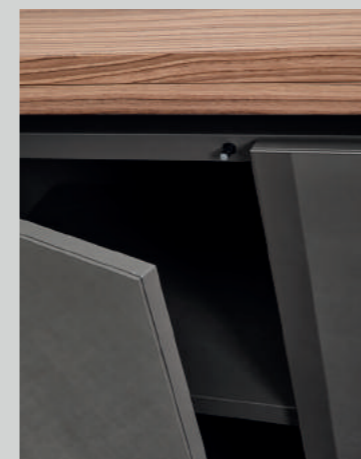

TWIST SYSTEM

Design Simone Cagnazzo

Il tavolo TWIST si trasforma in scrivania, attraverso la rotazione del piano superiore si crea uno scrittoio, che sdoppiandosi a libro, si trasforma a sua volta in un tavolo da studio. Sotto il tavolo sono ancorati diversi tipi di pensili: multivano, comodini ed elementi orizzontali, della collezione TUMIDEI. Il tavolo e i diversi tipi di pensili possono avere finitura in essenza (no i multivano), nobilitato o laccato.

TWIST table turns into desk. The rotation of the upper top creates desk which, once opened like a book, can be converted into a home office area. Under the desk, several kinds of hanging units are fixed onto wall: multi-section cabinets, drawers and horizontal boxes, from the TUMIDEI collection. Both table and boxes can be in wood (not for wall multi-section cabinets), melamine or lacquered finish.



Alla lunghezza del tavolo aperto vanno aggiunti 26/34 cm per lo spostamento del tavolo dal muro.
Add to the real length of the table 26/34 cm for the wall.

FOCUS



ESEMPI DI COMPOSIZIONE EXAMPLES OF CONFIGURATION

TWIST SYSTEM E PENSILI MULTIVANO

TWIST SYSTEM AND WALL MULTI-SECTION CABINETS

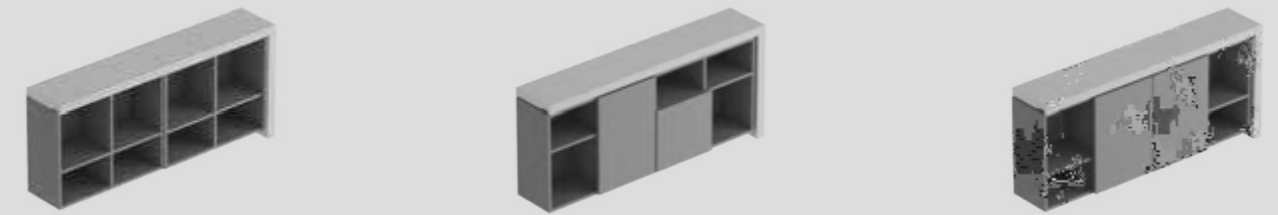

L / W 171,4 cm H 78,8 cm P / D 33,1 / 66,3 cm tavolo aperto open table



L / W 131,2 cm H 78,8 cm P / D 33,1 / 66,3 cm tavolo aperto open table

Alla lunghezza del tavolo aperto vanno aggiunti 26 cm per lo spostamento del tavolo dal muro.
Add 26 cm to the real length of the table to shift it from wall.

TWIST SYSTEM E PENSILI ORIZZONTALI

TWIST SYSTEM AND WALL HORIZONTAL BOXES

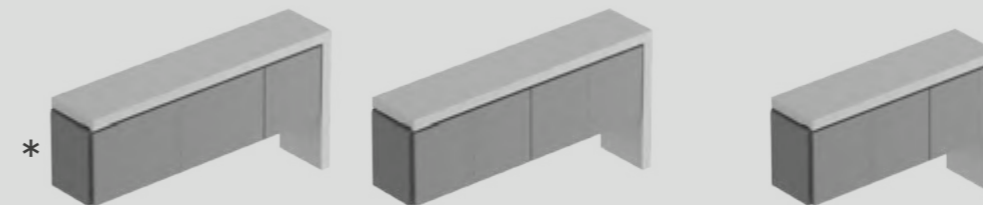

* L / W 154,8 cm H 78,8 cm P / D 33,1 / 66,3 cm tavolo aperto open table
+ 2 cm pannello + 2 cm panel

L / W 118,8 cm H 78,8 cm P / D 33,1 / 66,3 cm tavolo aperto open table
+ 2 cm pannello + 2 cm panel

Alla lunghezza del tavolo aperto vanno aggiunti 26 cm per lo spostamento del tavolo dal muro.
Add 26 cm to the real length of the table to shift it from wall.

TWIST SYSTEM E COMODINI PENSILI

TWIST SYSTEM AND HANGING NIGHT TABLES

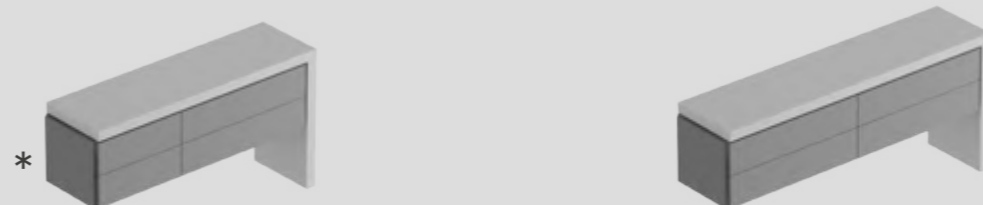

* L 140,6 cm H 78,8 cm P / D 41,1 / 82,3 cm tavolo aperto open table
+ 2 cm pannello + 2 cm panel

L 169,8 cm H 78,8 cm P / D 41,1 cm / 82,3 cm tavolo aperto open table
+ 2 cm pannello + 2 cm panel

Alla lunghezza del tavolo aperto vanno aggiunti 34 cm per lo spostamento del tavolo dal muro.
Add 34 cm to the real length of the table to shift it from wall.

* Pannello necessario per permettere la rotazione del tavolo in caso di accostamento a colonna / armadio / muro
Necessary panel to allow the rotation of the table in case of combination with column / wardrobe / wall

SLIP

Design Simone Cagnazzo



L / W 111 cm H 75,7cm P / D 49,2 cm



L / W 111 cm H 75,7cm P / D 249,2 cm

La consolle SLIP, pratica e decorativa, può essere utilizzata come consolle discreta da ingresso, o può diventare un tavolo da pranzo a tutti gli effetti: grazie ad un semplice meccanismo telescopico, è sufficiente spostare frontalmente il piano per fruire della massima estensione.

The SLIP console is a practical and decorative accessory which can be used as a sober lobby console or a dining table: thanks to its simple telescopic mechanism, you just have to frontally move the top in order to make use of the maximum extension.

TAVOLO ESTRAIBILE PULL-OUT TABLE



L / W 92 cm H 27,5 cm P / D 46,2 cm

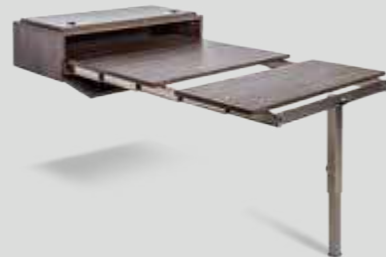

tavolo aperto open table P / D 136,8 cm H 73 cm

Mensola trasformabile in tavolo allungabile fino a una dimensione massima di 180,7 cm. Gamba ad apertura telescopica in metallo, struttura e piani realizzati con i nostri melaminici.

A shelf which turns into an extendible table till the maximum length of 180,7 cm. With telescopic support in metal, structure and top in melamine.

LINEUP SHELF

Design Simone Cagnazzo



L / W 110 cm H 40,8 cm P / D 27,5 cm



L / W 110 cm H 27,5 cm P / D 27,5 cm
L / W 110 cm H 20,4 cm P / D 27,5 cm



L / W 74 cm H 40,8 cm P / D 27,5 cm



L / W 74 cm H 27,5 cm P / D 27,5 cm
L / W 74 cm H 20,4 cm P / D 27,5 cm



L / W 40,8 cm H 40,8 cm P / D 27,5 cm



L / W 40,8 cm H 27,5 cm P / D 27,5 cm
L / W 40,8 cm H 20,4 cm P / D 27,5 cm

La collezione LINEUP offre elementi versatili e modulari, pensati per decorare ambienti di ogni genere. Una collezione ultraccontemporanea per le sue linee basiche e l'idea innovativa, per la personalizzazione dei colori e finiture. Le mensole sono realizzate con piani in metallo ad alta resistenza, verniciati in colore nero. I pannelli a muro sono disponibili nella vasta gamma di finiture in essenza, nobilitato e laccato della collezione TUMIDEI.

The LINEUP collection provides adjustable and modular elements, designed to decorate every interior space. An ultramodern collection thanks to its basic lines and the chance of customizing colours and finishes. The shelves are carried out with high-resistance metal top, painted in black colour. Wall panels are available in the whole range of finishes: wood, melamine and lacquered from the TUMIDEI collection.

FRAME

Design Simone Cagnazzo

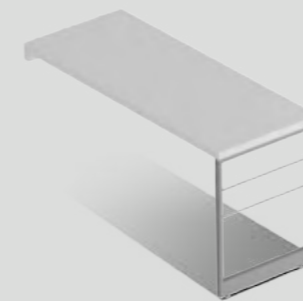

L / W 3 cm H 73,2 cm P / D 58,8 cm

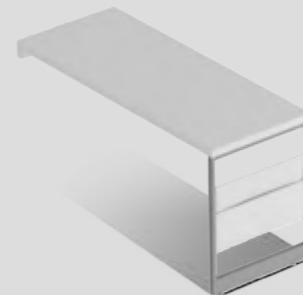

Tasca porta oggetti
Storage pocket

FRAME è una struttura di sostegno in metallo per piani e scrittoi, caratterizzata da una tasca centrale in tessuto, che diventa un pratico contenitore, discreto e funzionale.

Può essere utilizzato come terminale di una scrivania o composto in varie configurazioni per creare tavoli e scrivanie, è presentato in duplice versione: dotato di ruote, oppure con piedi antiscivolo per tavoli free-standing. FRAME può essere laccato in tutti i colori della gamma TUMIDEI, mentre i piani scrittorio sono sempre in nobilitato o essenza.

FRAME is a supporting structure in metal for tops and desks, characterized by a central pocket in fabric, which turns into a practical, discreet and functional storage unit. It can be used as simple support of a desk or composed in several configurations. Two versions are available: with castors or non-slip feet for freestanding tables. FRAME can be lacquered in all the colours of the TUMIDEI range, whereas the writing tops are always in melamine or wood finish only.

ABLE ARMCHAIR

Design Simone Cagnazzo



L / W 66 cm H 63 cm P / D 66 cm

La poltroncina si può ribaltare trasformandosi in piano d'appoggio o in comoda panca centro stanza per due o tre ospiti. L'imbottito è caratterizzato dal dettaglio della maniglia in pelle, che permette la trasformazione e l'appoggio a terra dello schienale. Il rivestimento può essere in tessuto o pelle.

The armchair can be overturned, becoming a flat surface or a practical bench for two or three guests. One of the main features is the leather handle, which enables to transform the armchair by resting the back on the floor. The covering can be in fabric or leather.



L / W 66 cm H 31,5 cm P / D 132 cm

ABLE POUF

Design Simone Cagnazzo



L / W 66 cm H 63 cm P / D 66 cm

ABLE è inoltre dotata di un ottomano imbottito con piano trasformabile in coffee-table. Il rivestimento può essere in tessuto o pelle.

ABLE is also supplied with an upholstered ottoman with convertible top into a coffee table. The covering can be in fabric or leather.



Poggiapiedi Footrest
L / W 52 cm H 28 cm P / D 58 cm

Tavolino Coffee table
L / W 52 cm H 28 cm P / D 58 cm

ON-OFF CLUB CHAIR

Sedia / poltroncina con contenitore. Sotto la seduta si trova un capiente contenitore. Rivestimento disponibile in tutti i tessuti della collezione Tumidei.

Chair / club chair with storage unit. Under the seat, there is a large container. The covering is available in all the fabrics from the Tumidei collection.



Sedia con contenitore
Chair with storage unit
L / W 49 cm H 80,5 cm P / D 50 cm

Poltroncina con contenitore
Club chair with storage unit
L / W 54,5 cm H 80,5 cm P / D 50 cm



ON-OFF BED ARMCHAIR

Elementi di seduta in dimensioni contenute, interpretati con gusto e rivestibili con le stesse scelte del divano. In questa pagina la poltrona a letto che, in meno di un metro quadro, racchiude un vero e proprio letto singolo.

Small seat unit, tastefully designed, to be covered matching the same fabrics of the sofa. This bed armchair encloses a real single bed in no more than one square meter.



L / W 81,5 cm H 73 cm P / D 83 cm



L / W 81,5 cm H 73 cm P / D 203,5 cm

PILL POUF

Design Simone Cagnazzo



SMALL
Ø 45 cm H 47 cm



MEDIUM
Ø 75 cm H 35 cm

PILL è un complemento decisamente moderno, originale e soprattutto versatile poiché può prestarsi contemporaneamente a diversi usi: sollevando la seduta sulla parte superiore del pouf, si accede ad un vano dove riporre i propri oggetti personali, girando e riposizionando la seduta, diventa un pratico coffee-table. Il rivestimento può essere in tessuto o pelle.

PILL is a modern, original and, especially, versatile accessory since, at the same time, it is suitable for different uses: under the pouf seat, there is a place to put the personal items into and, by flipping and replacing the seat, the pouf turns into a practical coffee-table. The covering can be in fabric or leather.



PILL POUF



LARGE
Ø 99 cm H 35 cm

Un solo oggetto può fungere da seduta, da comodino e da scrigno nascosto. PILL è un pouf che arreda la casa e gli spazi contract con una fresca energia. Il pouf è caratterizzato dal dettaglio della maniglia in pelle, che permette l'apertura e la trasformazione dal pouf seduta a coffee-table. Il rivestimento può essere in tessuto o pelle.

A single item works as a seat and as a coffee-table with a secret trunk. PILL is a pouf which decorates your home and contract locations too with a fresh energy. One of the main features is the leather handle, which enables to open the pouf and to transform it into coffee-table.



ON-OFF POUF



L / W 83 cm H 40 cm P / D 91 cm

Il pouf, già presente nell'insieme degli elementi componibili del divano On-Off, si può trasformare in un altro comodo contenitore per coperte, guanciali, libri. Rivestimento disponibile in tutti i tessuti della collezione Tumidei.

The pouf, forming part of the modular elements of the On-Off sofa, can be converted into another practical storage unit for blankets, pillows, books. The covering is available in all the fabrics from the Tumidei collection.



ON-OFF POUF



L / W 49 cm H 52,5 cm P / W 50 cm

Pouf con comodo vano contenitivo dove riporre quello che non trova mai posto in altre zone della casa. Rivestimento disponibile in tutti i tessuti della collezione Tumidei.

Pouf with a practical storage box. The covering is available in all the fabrics from the Tumidei collection.



FINISHES

DRESS IMAGE

MANIGLIE

LACCATI

NOBILITATI

ESSENZE

TESSUTI

DRESS IMAGE

HANDLES

LACQUERED

MELAMINES

WOOD

FABRICS



CARTA DA PARATI IN FIBRA DI VETRO
WALLPAPER IN GLASS FIBERS

Carta da parati in tessuto realizzato con filati speciali di fibre di vetro molto sottili, ignifugo omologato in classe 1. Il tessuto è ecologico e igienico, realizzato con materie prime naturali non è né tossico né contaminabile da agenti biologici. "Certificato da Greenguard", seguendo severi metodi di laboratorio, ed è risultato in linea con gli standard del programma Greenguard Indoor Air Quality.

Wallpaper fabric made with special yarns of very thin glass fibres, fireproof and homologated in CLASS 1. The fabric is ecological and hygienic, made with natural raw materials and it is non-toxic, neither contaminated by biological agents. "CERTIFIED BY GREENGUARD" means that the product was tested following strict laboratory methods, and the result complies with the standards set out in the Greenguard Indoor Air Quality program.



PANNELLI DECORATI CON STAMPE DIGITALI
PANELS WITH DIGITAL PRINTS

Stampe digitali per pareti, armadi e pannellature.
Digital prints for wardrobes and panels.

TUMIDEI utilizza per tutte le ante di armadi comprese quelle con la stampa digitale legni che provengono da coltivazioni ecosostenibili, a basso contenuto di formaldeide e finiti con vernici all'acqua con barriere igienizzanti antibatteriche.

TUMIDEI uses for all its wardrobe doors, also the ones with digital print, wood coming from eco-sustainable cultivated land, with a low-formaldehyde content and lacquered with water-based paints with anti-bacterial barriers.

Tutte le stampe sui prodotti ON OFF sono certificate con il sistema "GREENGUARD" un processo di certificazione in linea con gli standard del programma Greenguard Indoor Air Quality contro le emissioni inquinanti all'interno degli edifici.

All prints on ON OFF product are certified with "GREENGUARD" system, a certifying process complying with the standard set out in the Greenguard Indoor Air Quality program against polluting emissions inside buildings.



LEGENDA LEGEND

**PATTERNS**

Immagine con motivo decorativo replicabile a dimensione fissa o personalizzata.

Image with decorative motif to replicate with fixed or customized size.

**CUSTOM-SIZE**

Immagine con possibilità di scegliere una dimensione personalizzata.

Image with chance of customizing the size.

**FIXED-SIZE**

Immagine con dimensione altezza fissa con possibilità di scegliere la porzione da stampare. Sviluppate in grandi dimensioni potrebbero subire variazioni cromatiche e di definizione.

Image with fixed size (height) and chance of choosing the portion to be printed. Once printed in great dimension, the images might be subjected to changes in colours and resolution.

**CUSTOM-COLOUR**

Immagine personalizzabile con tutti i colori della collezione laccati Tumidei (max 2 colori modificabili).

Image to be customized with all the lacquered colours of the Tumidei collection (max 2 colours).

**COLOUR-PROJECT**

Immagine cromaticamente personalizzabile a progetto con tutti i colori della collezione laccati Tumidei (con supplemento di prezzo, vedi listino).

Image with colours to be customized by project with all the lacquered colours of the Tumidei collection (with supplemente, see pricelist).

DRESS IMAGE

Archivio Tumidei delle immagini fotografiche.

Tumidei's library of photographic images.



DECOR



WD321



WD362 * 1 colore 1 color



WD363 * ▲ ●



WD323



WD324



WD325



ART



WD333



WD335



WD327



WD329



WD330



WD336



WD337



WD340



WD331



WD357



WD358



WD341



WD344



WD345 * ▲ ●

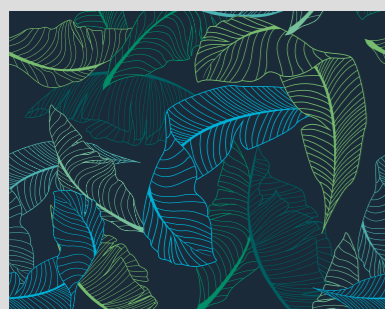

WD359 * ▲ ●



WD360



WD361 ▲ ●



WD364



WD365



WD366

DRESS IMAGE

DRESS IMAGE

DRESS IMAGE



WD367 ■



WD368 ■



WD369 ▲ ●

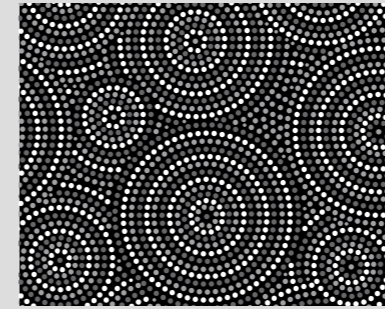

WD457 * ▲ ●

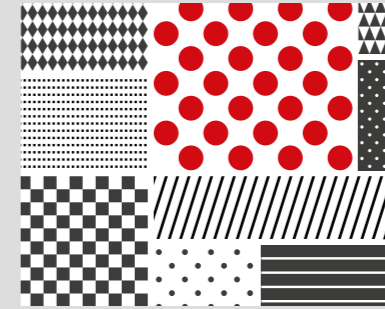

WD458 ▲ ●



WD459 * ▲ ●



WD370 ■

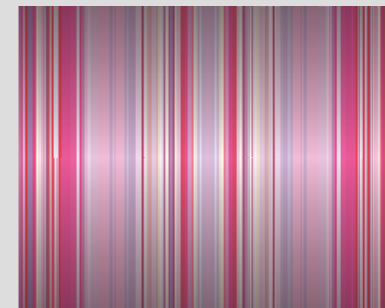

WD460 * ▲ ●



WD461 * ▲ ●



WD346 ■



WD347 ■

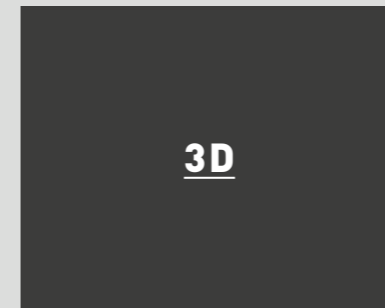

WD462 ● 1 colore 1 color

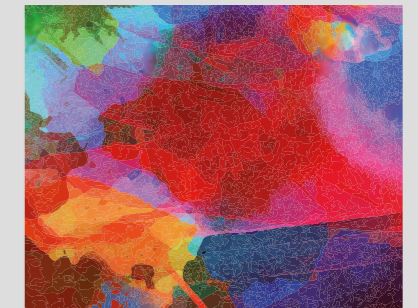

WD463 ■



WD351 * ▲ ●



WD352 * ▲ ●



WD355 ▲ ●



WD464 ■ 1 colore 1 color

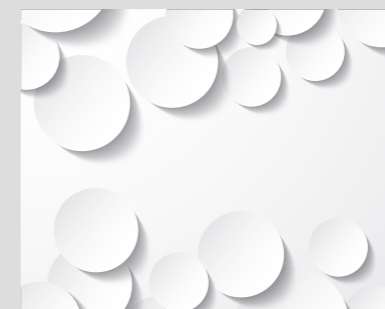

WD465 ▲ ●

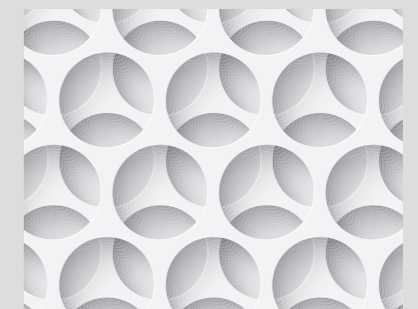

WD466 ▲ ● 1 colore 1 color



WD454 ■

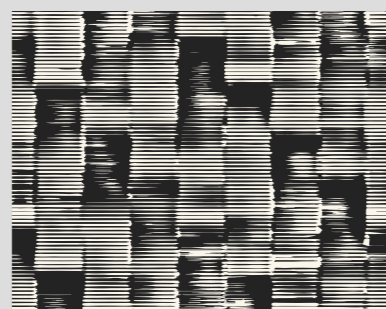

WD455 * ▲ ●



WD456 * ▲ ●

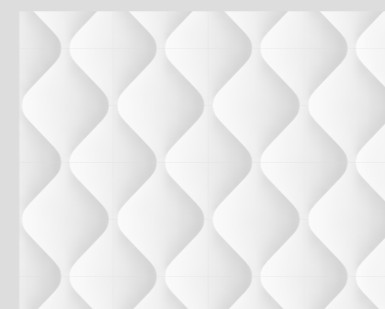

WD467 ▲ ● 1 colore 1 color

MANIGLIE HANDLES

MANIGLIE IN LEGNO E PVC WOODEN AND PVC HANDLES

PVC

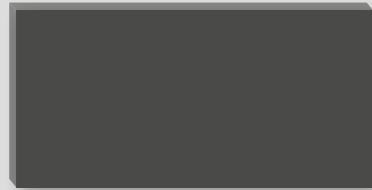

PX78
L / W 18 cm H 10 cm P / D 3,2 cm

Legno Wood



PX77
L / W 5 cm H 5 cm P / D 3,2 cm

PVC

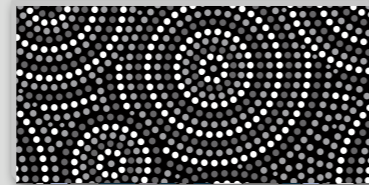

PX79
Immagine da archivio Tumidei o immagine cliente.
Image from Tumidei's library or from customer.

PVC



PX75
L / W 10 cm H 100 cm P / D 3,2 cm

Laccato in tutti i colori da campionario
Lacquered in all colours of the samples

PVC



PX76
L / W 10 cm H 100 cm P / D 3,2 cm

Immagine da archivio Tumidei o immagine cliente
Image from Tumidei's library or from customer

PVC



PX76
L / W 10 cm H 100 cm P / D 3,2 cm

MANIGLIE HANDLES

MANIGLIE IN LEGNO E ACCESSORI WOODEN HANDLES AND ACCESSORIES



PM41
PM41 H 8 cm



PM43
PM41B H 20 cm
PM42 H 33,8 cm
PM43 H 48,6 cm
PM44 H 84,4 cm

SIDE DESIGN BY SIMONE CAGNAZZO



PM67
PM65 H 11 cm
PM66 H 20 cm
PM67 H 110 cm



PM66



PM66



PM65



PM65

SIDE
Orizzontale
Horizontal

SIDE
Verticale
Vertical

APERTURA PUSH PULL PUSH PULL OPENING

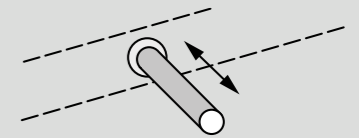

ZM40
Il push-pull va montato solo con ripiani profondità 54,9 cm e, per un funzionamento ottimale, posizionati al centro del vano utile. Solo per ante.
The push-pull opening must be installed on 54,9 cm depth shelves and, for the optimal use, they has to be positioned on the center of the block. Use for doors only.

NZ48
Serratura ad asta
Rod lock



SR12
Serratura a cilindro per cassetto
Cylinder lock for drawer



PX68
L / W 4,2 cm H 6,5 cm
Gancio appendiabiti
Coat hanger hook

MANIGLIE HANDLES

POMOLI E MANIGLIE IN LEGNO WOODEN KNOBS AND HANDLES



PM12L
Ø 2,4 cm

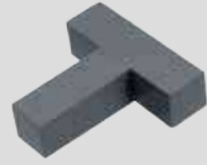

PX71
L / W 7 cm H 7 cm



PX18
L / W 6,2 cm H 5,5 cm P / D 2,5 cm



PX19
Ø 5 cm P 2,7 cm



PX35F Frassino naturale Natural Ash
PX35L Laccato a poro aperto Open pore lacquered
Ø 8 cm P 5 cm



PX36F Frassino naturale Natural Ash
PX36L Laccato a poro aperto Open pore lacquered
Ø 11 cm P 5 cm

POMOLI E MANIGLIE IN ALLUMINIO ALUMINIUM KNOBS AND HANDLES



PM12A
Ø 2,4 cm



PX22
L / W 3,2 cm P 1,6 cm



PX05
L / W 1,2 cm H 17 cm P / D 3,8 cm



PX04
L / W 1 cm H 7,4 cm P / D 3,2 cm



PM52
L / W 0,8 cm H 33 cm
P / D 3 cm



PX01
L / W 2,5 cm H 2,5 cm



PX02
L / W 7,4 cm H 2,5 cm

MANIGLIE HANDLES

MANIGLIE AD INCASSO CON INSERTO RECESSED HANDLES WITH INSERT



PX25LL h 8 cm
PX26LL h 20 cm
PX27LL h 40 cm
PX28LL h 80 cm
PX29LL h 120 cm



PX25LN h 8 cm
PX26LN h 20 cm
PX27LN h 40 cm
PX28LN h 80 cm
PX29LN h 120 cm

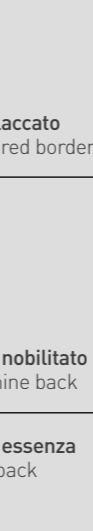

PX25LE h 8 cm
PX26LE h 20 cm
PX27LE h 40 cm
PX28LE h 80 cm
PX29LE h 120 cm

Bordo laccato
Lacquered border

Fondo laccato
Lacquered back

Bordo laccato
Lacquered border

Fondo nobilitato
Melamine back

Fondo essenza
Wood back

MANIGLIE AD INCASSO IN METALLO METAL RECESSED HANDLES

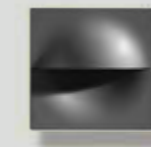

PX73
L 5,5 cm H 5,5 cm



PX74
L 11 cm H 11 cm



PX08
L 5,2 cm H 5,2 cm

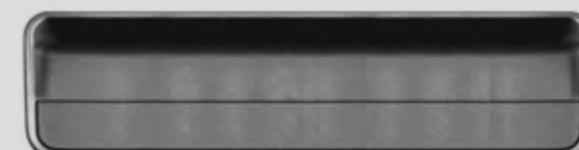

PX09
L 19,4 cm H 5,2 cm

MANIGLIE AD INCASSO RECESSED HANDLES

Ø 3,5 cm



PX06A

Fondo bianco
White back

Bordo alluminio
Aluminium border

Ø 5,2 cm



PX07A

Fondo bianco
White back

Bordo alluminio
Aluminium border

Ø 3,5 cm

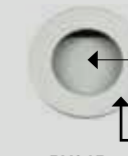

PX06B

Fondo bianco
White back

Bordo bianco
White border

Ø 5,2 cm

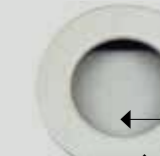

PX07B

Fondo bianco
White back

Bordo bianco
Aluminium border



CODE HANDLE

Design **Simone Cagnazzo**

SISTEMA FUNZIONALE E VERSATILE

La serie di maniglie Code, si sviluppano su tutto il profilo verticale dell'anta armadio, creando un gioco di pieni e vuoti, che dà carattere al sistema armadio. Sono disponibili in due differenti larghezze, possono essere personalizzate con le laccature della gamma Tumidei, in finitura vetro laccato e specchio in tre diverse finiture, ed è possibile personalizzarle con la grande collezione di grafiche presenti nel catalogo Tumidei.

FUNCTIONAL AND VERSATILE SYSTEM

The set of Code handles expands throughout all the vertical profile of the wardrobe door, creating a trick of fullness and emptiness which gives personality to the entire wardrobe system. They are available in two different widths and can be customized with the Tumidei lacquered colours, lacquered glass or three different mirror finishes. In addition to that, it is possible to customize them with the great range of Tumidei graphics collection.



PM63 L 12 cm H 227,1 cm
PM64 L 12 cm H 259,1 cm



PM61 L 20 cm H 227,1 cm
PM62 L 20 cm H 259,1 cm



NOBILITATO
BIANCO
ANTRACITE
MELAMINES
WHITE
ANTRACITE

LACCATO
LACQUERED

VETRO SPECCHIATO
BRONZO
GRIGIO
MIRRORED GLASS
BRONZE / GREY

VETRO RETRO
LACCATO
BACK
LACQUERED GLASS

DRESS IMAGE
COLLECTION
WD 402
DECOR

ESEMPI DI COMPOSIZIONE EXAMPLES OF CONFIGURATION

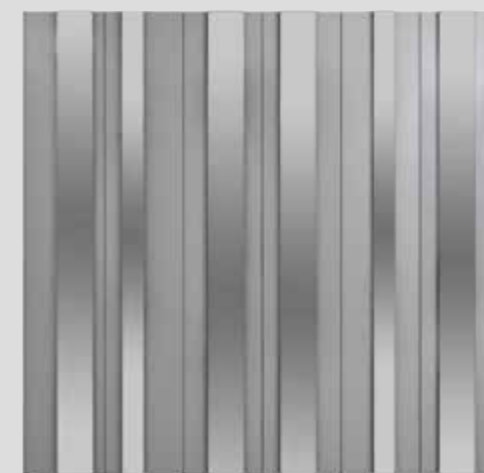

La maniglia Code può essere montata a 10 cm oppure a filo anta.
The Code handle can be assembled at 10 cm or on the door edge.



CODE HANDLE

Design Simone Cagnazzo

Esempi di personalizzazione maniglia Code.
Example of Code handle customization.



DRESS IMAGE
COLLECTION
WD455

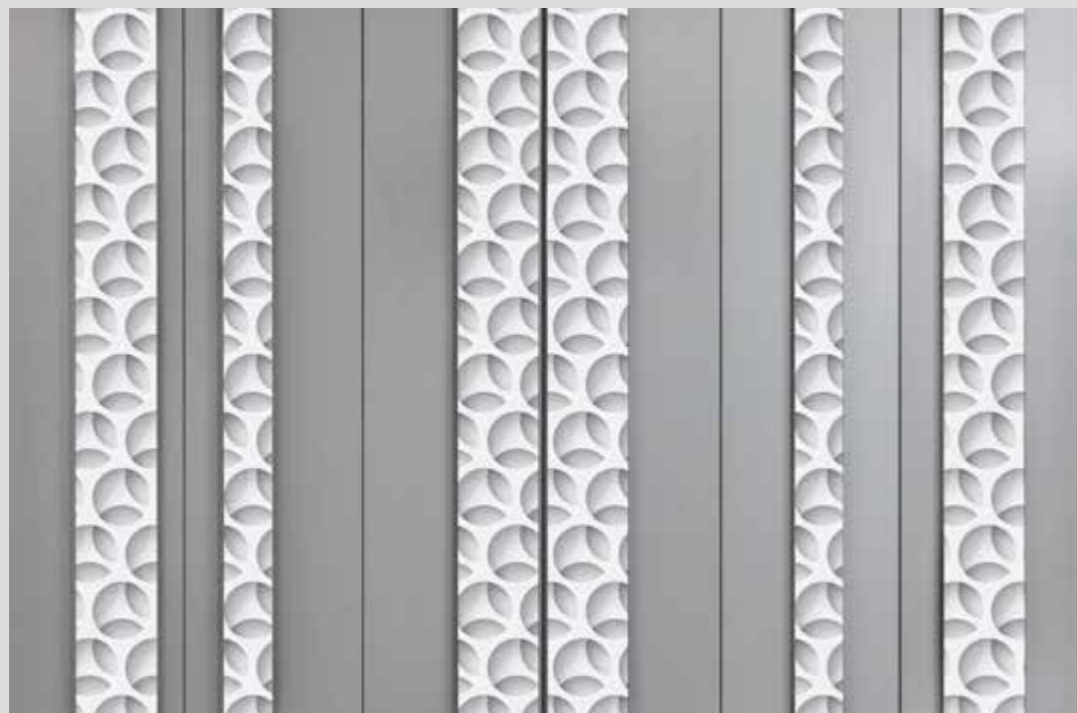

DRESS IMAGE
COLLECTION
WD466

Le maniglie Code sono personalizzabili con la selezione di immagine tratte dalla collezione Dress Image.

The Code handles can be customized with the selection of images taken from the Dress Image collection.



WD368



WD369



WD370



WD346



WD347



WD351



WD352



WD454



WD455

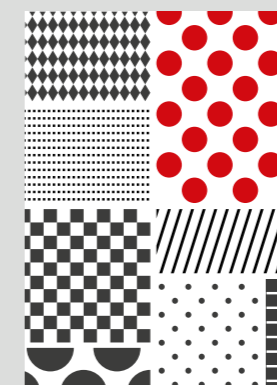

WD458



WD465

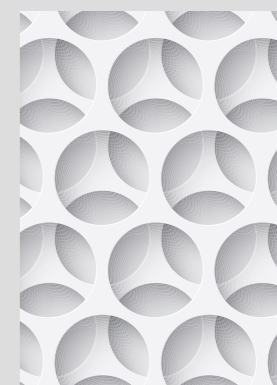

WD466

FINITURE FINISHES

ESSENZE WOODS

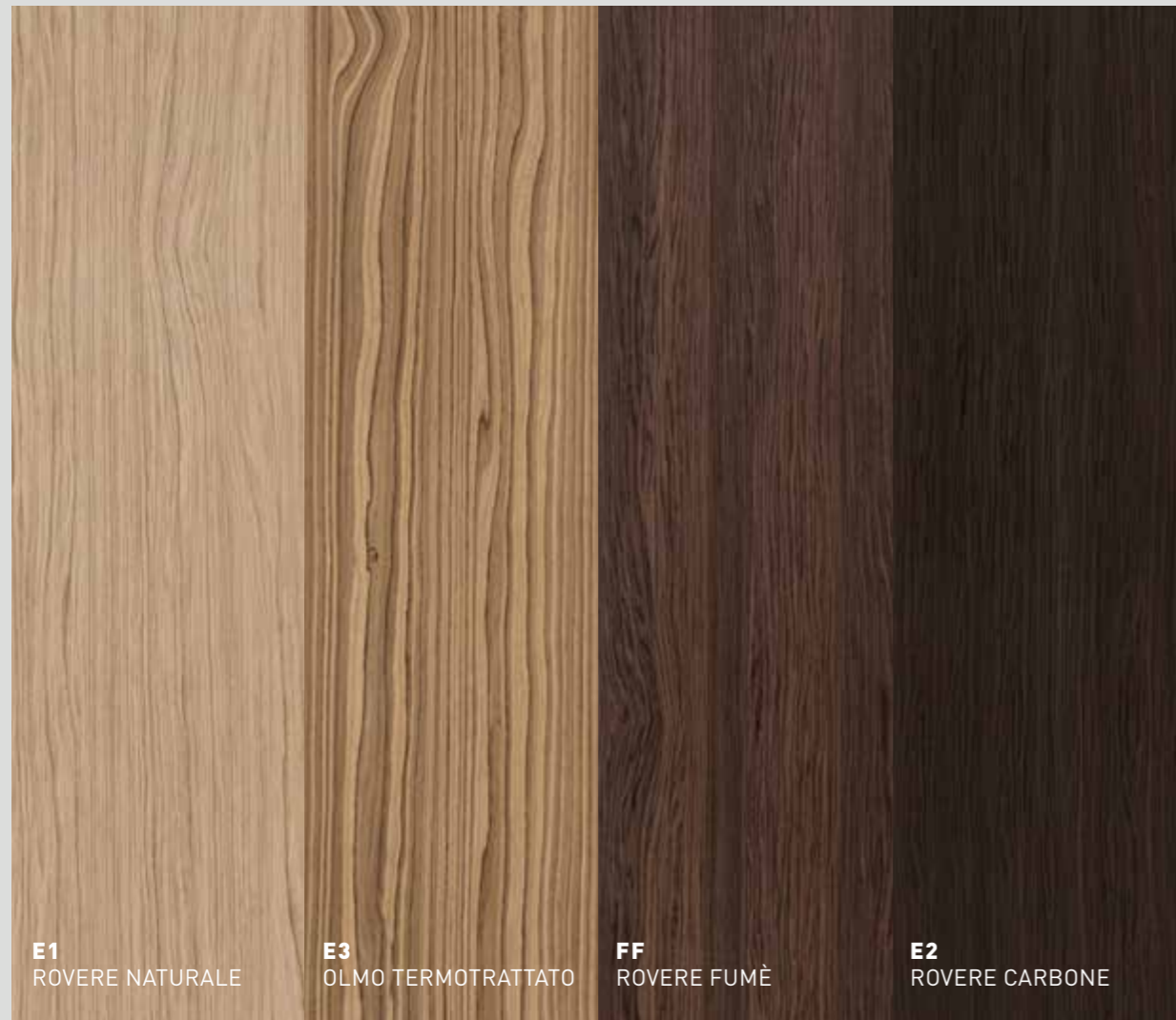

Colori indicativi. Per verificare i toni reali consultare campioni.
Colours as indications. In order to check the real shades, refer to samples.

FINITURE FINISHES

NOBILITATI PER FRONTALI MELAMINES FOR FRONT PARTS



Colori indicativi. Per verificare i toni reali consultare campioni.
Colours as indications. In order to check the real shades, refer to samples.

FINITURE FINISHES

NOBILITATI PER INTERNI MELAMINES FOR INNER PARTS



ALLUMINIO - ATTREZZATURE INTERNE ALUMINIUM - INNER PARTS

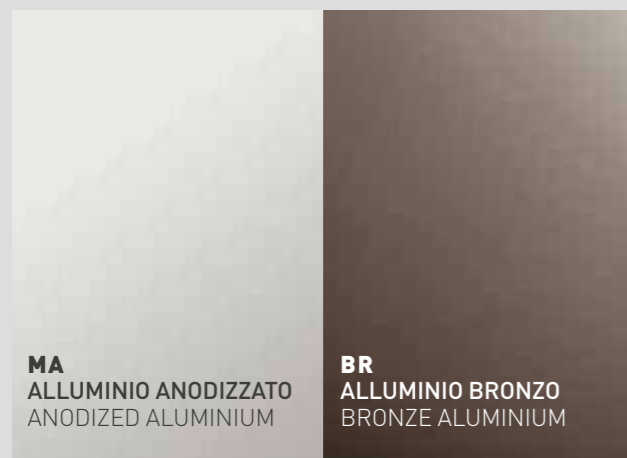

Anta vetro fumè con struttura alluminio nero
Smoked glass door with structure in black aluminium

TUBO PORTA ABITI HANGING RAIL

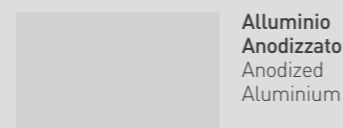
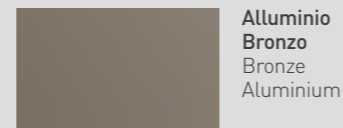

PORTAPANTALONI PULL-OUT RACK FOR TROUSERS



CONTENITORI ESTRAIBILI PULL-OUT SHELVES AND BOWLS

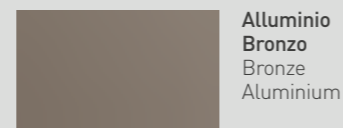

FINITURE FINISHES

LACCATI LACQUERED

43	69	57	18	40	30
Mandarino	Mustard Yellow	Melone	Yellow Rose	Sabbia	Rosa Delicata
83	73	04	03	02	14
Caramello	Verde Jungla	Verde Lime	Verde Tè	Verde Pastello	Cielo
10	79	54	68	49	66
Imola	Ribes	Melanzana	Lampone	Tintoretto	Glicine
71	44	82	24	47	41
Blu Prussia	Cina	Azzurro Polvere	Avio	Argilla	Cappuccino
35	29	78	09	65	01
Avana	Caffè	Tortora	Biscotto	Corda	Magnolia
50	46	81	48	55	42
Lavagna	Muschio	Grigio Fumè	Pioggia	Alluminio	Ghiaccio
20	39				
Nero	Bianco				

Colori indicativi. Per verificare i toni reali consultare campioni.
Colours as indications. In order to check the real shades, refer to samples.

FINITURE FINISHES

TESSUTI FABRICS

VETRO SPECCHIATO MIRRORED GLASS



Colori indicativi. Per verificare i toni reali consultare campioni.
Colours as indications. In order to check the real shades, refer to samples.

VETRO EXTRACHIARO RETRO LACCATO BACK LACQUERED EXTRA-CLEAR

Codici riferimento Laccati
Reference code Lacquered



Colori indicativi. Per verificare i toni reali consultare campioni.
Colours as indications. In order to check the real shades, refer to samples.

CAN CAN - TeD



CAN011

CAN002

CAN025



CAN012

SCUBIDU VICHY- TeB



SCU004

SCU007

SCU006

CONNERY- TeD



CON100

CON032

CON007

Colori indicativi. Per verificare i toni reali consultare campioni.
Colours as indications. In order to check the real shades, refer to samples.

ASTON - TeE



AST025 AST003 AST092

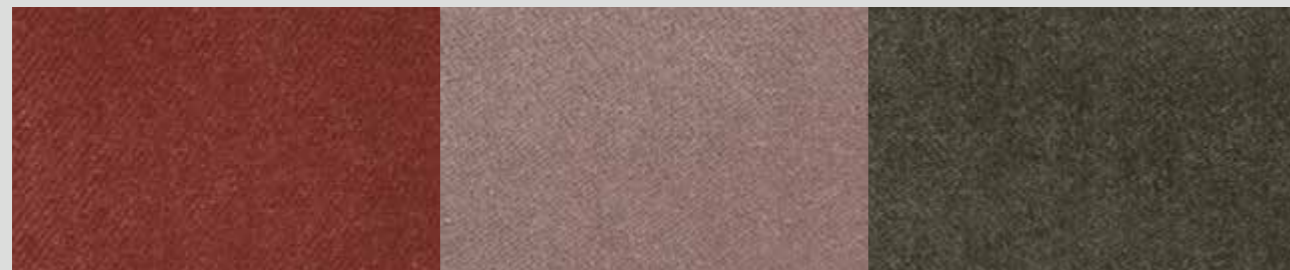

AST053 AST029 AST099

DEUS - TeE



DEU100 DEU413 DEU603



DEU319 DEU604 DEU611



DEU704 DEU800

Colori indicativi. Per verificare i toni reali consultare campioni.
Colours as indications. In order to check the real shades, refer to samples.

BLIZZARD - TeD



BLI018 BLI021 BLI023



BLI016 BLI001 BLI005

MIZAR - TeA



MIZ009 MIZ011 MIZ010



MIZ020 MIZ014 MIZ006

Colori indicativi. Per verificare i toni reali consultare campioni.
Colours as indications. In order to check the real shades, refer to samples.

TESSUTI FABRICS

SESIA - TeB



SES012

SES009

SES028



SES026

SES005

SES030



SES029

SES021

SES003



SES023

SES033

SES016

Colori indicativi. Per verificare i toni reali consultare campioni.
Colours as indications. In order to check the real shades, refer to samples.

TESSUTI FABRICS

GRACE - TeA



GRA001

GRA016

GRA015



GRA022

GRA009

GRA030



GRA006

GRA012

GRA033

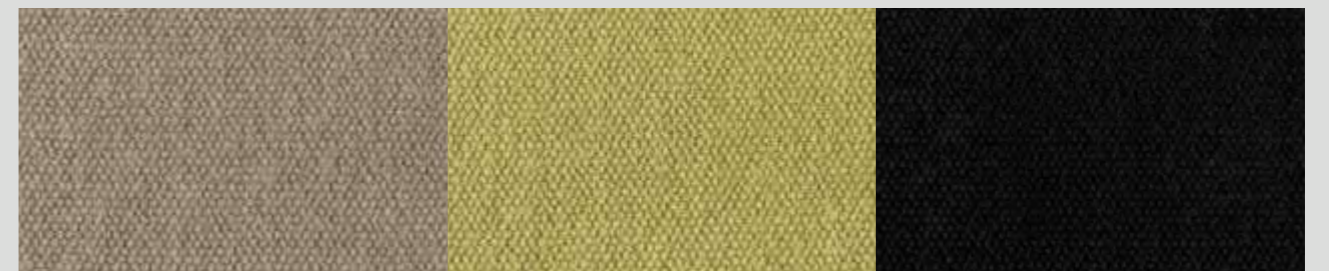

GRA010

GRA011

GRA036

Colori indicativi. Per verificare i toni reali consultare campioni.
Colours as indications. In order to check the real shades, refer to samples.

TESSUTI FABRICS

PELLE MARTELLATA - PeA



MAR765

MAR769

MAR744

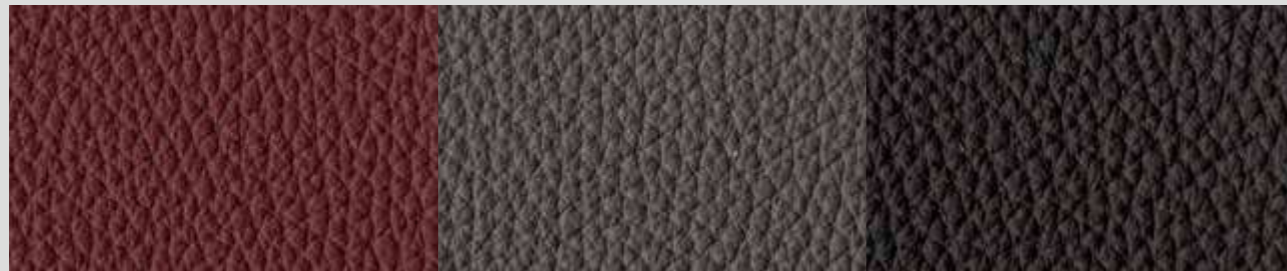

MAR747

MAR752

MAR731

ELEGANCE - PeB



ELE301

ELE304

ELE204

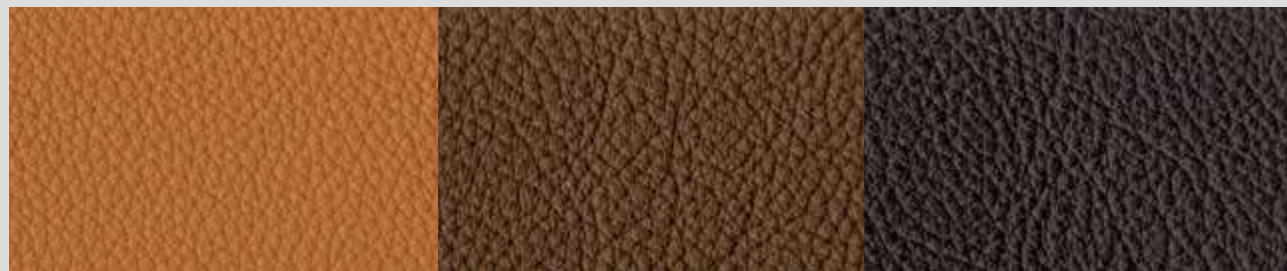

ELE218

ELE217

ELE207

Colori indicativi. Per verificare i toni reali consultare campioni.
Colours as indications. In order to check the real shades, refer to samples.

TESSUTI FABRICS

SAUVAGE - PeB



SAU031

SAU032

SAU034

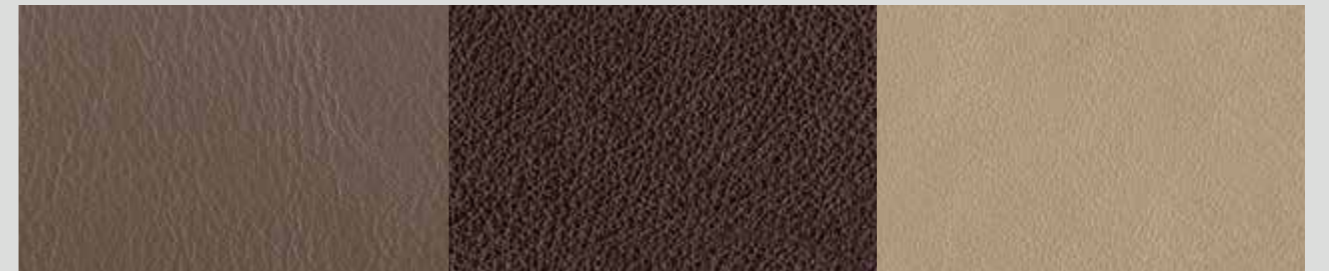

SAU036

SAU037

SAU038

ECOPELLE - TeA



ECO111

ECO101

ECO606

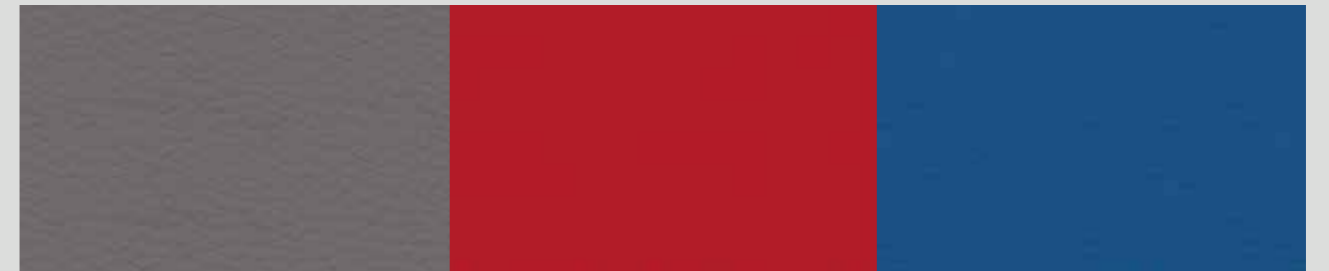

ECO604

ECO315

ECO710

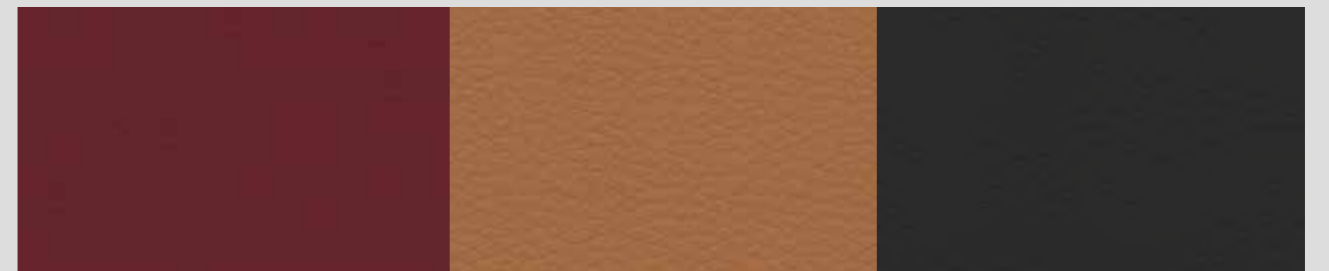

ECO313

ECO412

ECO200

Colori indicativi. Per verificare i toni reali consultare campioni.
Colours as indications. In order to check the real shades, refer to samples.

TUMIDEI®



Nata nel 1958 a Predappio di Romagna, la Tumidei ha alle spalle oltre cinquant'anni di attività in un'epoca caratterizzata in tutto il mondo da un mutamento radicale nella concezione della casa, nel modo di vivere della famiglia e, quindi, nell'arredamento. La ricerca continua di soluzioni d'arredo sempre più sofisticate ed in linea con le esigenze del consumatore ha rappresentato uno dei fattori di successo dell'azienda e lo stimolo per una crescita ponderata e costante nel tempo. Si è creata un'azienda moderna ed attrezzata, che oggi dispone di circa 100 dipendenti e di una superficie di 20.000 mq. Un'azienda di produzione in grado di gestire al meglio l'intera catena produttiva e di garantire la "qualità del prodotto". Qualità, Sicurezza ed Ambiente sono al centro delle strategie della nostra azienda, certificata in conformità alle norme ISO 9001, OHSAS 18001 e ISO 14001. È con grande orgoglio da parte della Direzione, che TUMIDEI ha raggiunto questo traguardo che ad oggi risulta essere, per il settore legno e arredamento, tra le prime certificazioni integrate, emesse dall'Ente di certificazione ICILA marchio di CSI s.p.a. (Gruppo IMQ), ottenendo inoltre il certificato di "ECCELLENZA" rilasciato dall'ente stesso, che sta a testimoniare l'impegno dell'organizzazione a gestire in modo sistematico e secondo modelli standard internazionali riconosciuti, aspetti organizzativi rilevanti e complessi, cioè l'efficacia, l'efficienza, l'impatto ambientale, la salute e la sicurezza dei lavoratori, il trattamento responsabile dei collaboratori, nell'ottica del miglioramento continuo delle prestazioni e dell'impatto sociale delle attività dell'organizzazione. Tumidei utilizza pannelli con certificazione CARB Phase 2, in vigore dal 01/01/2011, che assicura emissioni di formaldeide inferiori a 0.09 ppm.

Sistema Integrato
QUALITÀ - SICUREZZA - AMBIENTE

Integrated System
QUALITY - ENVIRONMENT - SECURITY



Born in 1958 in Predappio di Romagna, Tumidei has over 50 years of experience. During this time-lapse, people all over the world have radically changed their idea of home, of family life and, as a consequence, of interior design. The continuous search for the most sophisticated consumer driven solutions for interior design represents one of the main success factors for Tumidei and the reason for their weighted and consistent growth. Tumidei is now a state-of -the-art business with a modern equipment and ca. 100 employees and 20,000 sq mt of facilities, capable of managing the production chain at its best, guaranteeing the product's best quality. Tumidei is a UNI EN ISO 9001 (quality) ISO 14001 (environment) and OHSAS 18001 (security) certified Company. Tumidei's board is very proud to have achieved this target, also because as of today this is one of the first certifications issued by the ICILA INSTITUTION, brand of CSI s.p.a. (IMQ group) within the wood and furniture sector, to a Company dedicated to home design furnitures. The certification authority has also awarded Tumidei with a certificate of "EXCELLENCE", for its commitment to systematically manage all relevant and complex aspects of the organization (such as effectiveness, efficiency, environmental impact, the workers' health and safety and the fair treatment of co-workers) according to the international standards, towards the continuous improvement of performances and social impact of the Company's activities. Tumidei uses CARB Phase 2 certified panels, in force since 01/01/2001, that ensures formaldehyde emissions below 0.09 ppm.



ATLGROUP®

ATL Group è proprietaria di tre complessi immobiliari per complessivi 65.000 mq coperti. L'azienda opera principalmente su due stabilimenti di proprietà uno dislocato a Faenza (RA) ed uno a Bertinoro (FC), mentre il complesso immobiliare industriale di Forlì è in parte utilizzato dalla Cooperativa CIPES ed in parte destinato a magazzino. Lo stabilimento di Faenza ha una superficie coperta di circa 45.000 mq ed è dedicato alle prime lavorazioni comuni a tutte le linee di prodotto: la falegnameria e il taglio del poliuretano espanso. Nello stesso vengono inoltre svolte le lavorazioni intermedie e finali, taglio, cucito e montaggio, dei prodotti finiti di gamma media e le lavorazioni speciali per le forniture di "contract" e di semilavorati per altri rinomati produttori del settore dell'arredamento. Lo stabilimento di Bertinoro ha una superficie coperta di circa 10.000 mq ed è dedicato alle lavorazioni intermedie e finali per i prodotti di alta gamma: taglio dei rivestimenti in pelle e tessuto, cucito e montaggio. Lo stabilimento di Forlì ha una superficie coperta di circa 10.000 mq ed è oggi utilizzato quale magazzino e come sede operativa della Cooperativa CIPES, che tuttora svolge l'originaria attività di lavorazioni di resine espansive limitatamente ad alcune produzioni speciali.

ATL Group owns three building complexes for a total of 65,000 square meters. The company mainly works in two of these factories, one situated in Faenza (RA) and one in Bertinoro (FC), while the industrial complex in Forlì is partly used by the Cooperative CIPES and partly as a warehouse. The factory in Faenza (RA) has a surface area of approximately 45,000 square meters and is dedicated to first processing phases, common to all product lines as woodworking and cutting of polyurethane foam. In the same premises other manufacturing processes take place as well: cutting, sewing and assembling of mid-range products; special processing for "contract" supplies and semi-finished furniture products for other well-known manufacturers working in the furniture sector. The factory in Bertinoro (FC) has a surface of approximately 10,000 square meters and is dedicated to intermediate and final processing for high-end products: leather and fabric cutting, sewing and assembly. The Forlì unit has a surface of approximately 10,000 square meters and is now used as a warehouse and as the headquarters of the Cooperative CIPES, which still carries out the original business: the processing of polyurethane foams limited to some special productions.



Art Direction

Paola Citterio

Concept

Michela Boglietti

Graphic design

Studioopera

Rendering

Marco Rossetti

Set designer

Paola Citterio

Photo

Marco Anconelli

Riccardo Bianchi

Puntozero

Colour separation

CD Cromo

Print

Modulgrafica

Printed in Italy 6.2018

© 2018, TUMIDEI Spa

Tutti i diritti riservati.

Nessuna parte del presente catalogo

può essere riprodotta o diffusa

con un mezzo qualsiasi, fotocopie,

microfilm o altro, senza il permesso

del titolare del copyright.

All rights reserved.

No part of this catalogue may be

reproduced or transmitted in any way,

by photocopying, microfilm or else,

without permission of the copyright holder.

Le tonalità dei colori rappresentati nel Wallimage

e nel Doorimage, non potranno mai essere

riprodotte fedelmente, sia in relazione al nostro

campionario laccati, che alle immagini presenti

nei nostri cataloghi.

The shade of the colours shown in Wallimage

and Doorimage cannot be faithfully

reproduced, with regard to our lacquered

samples and to the images which are present

in our catalogues.

TUMIDEI®

S. Cassiano in Pennino 57/A - 47016 Predappio (FC) Italy

T. +39 0543.921.076 r.a. - F. +39 0543.921.079

info_italia@tumidei.it - export@tumidei.it - www.tumidei.it



