

TIRAMOLLA

SMART
ITALIAN
PROJECTS



t
TUMIDEI

S M A R

T I T A

L I A N

P R O J

E C T S

TABLE OF CONTENT

TIRAMOLLA

Smart italian projects

SOPPALCHI CON TRAFILA

277/ Mezzanines with profiles

LETTI SCORREVOLI CON TRAFILA

147/ Sliding beds with profiles

LETTI SCORREVOLI

217/ Sliding beds

PONTI CON TRAFILA

235/ Bridges with profiles

PONTI CON TERMINALE

277/ Bridges with end unit

EASY

311/ Easy System

PONTI A SBALZO

395/ Overhang bridges

LETTI A RIBALTA

435/ Foldaway beds

CABINE

503/ Walk-in-closets

DRESS IMAGE

535/ Dress image collections

LETTI E COMPLEMENTI

553/ Beds and accessories

MANIGLIE E FINITURE

599/ Handles and finishes

INDEX COMPOSIZIONI

614/ Configurations index



UN'AZIENDA ED IL SUO TERRITORIO

Fondata nel 1958 a Predappio di Romagna, Tumidei ha alle spalle oltre cinquant'anni di attività in un'epoca caratterizzata in tutto il mondo da un mutamento radicale nella concezione della casa, nel modo di vivere della famiglia e, quindi, nell'arredamento. La ricerca continua di soluzioni d'arredo sempre più sofisticate ed in linea con le esigenze del consumatore ha rappresentato uno dei fattori di successo dell'azienda e lo stimolo per una

crescita ponderata e costante nel tempo. Si è creata un'azienda moderna ed attrezzata, che oggi dispone di circa 100 dipendenti e di una superficie di 15.000 mq. Un'azienda di produzione in grado di gestire al meglio l'intera catena produttiva e di garantire la "qualità del prodotto". Tumidei è certificata secondo le norme UNI EN ISO 9001 (qualità), ISO 14001 (ambiente), OHSAS 18001 (sicurezza).

A COMPANY AND ITS AREA

Founded in 1958 in Predappio di Romagna, Tumidei has over 50 years of experience. In this time span, people all over the world have radically changed their idea of home, family life and, consequently, of interior design. The ongoing research for extremely sophisticated, consumer driven solutions for interior design is one of Tumidei's success factors and the reason for the Company's well-pondered and consistent growth. Tumidei is now a state-of-the-art business with about 100 employees and 15.000 sqm premises, where the production chain is managed at its best, guaranteeing top quality products. Tumidei is certified UNI EN ISO 9001 (quality), ISO 14001 (environment) and OHSAS 18001 (safety).

UNE ENTREPRISE ET SON TERRITOIRE

Née en 1958 à Predappio di Romagna, Tumidei est forte de plus de cinquante ans d'activité à une époque qui aura été marquée, dans le monde entier, par un changement radical de la conception de la maison, de la façon de vivre en famille et donc de l'ameublement. Ses recherches continues, qui ont donné naissance à des solutions d'ameublement toujours plus sophistiquées et conformes aux exigences des consommateurs, ont constitué l'un des facteurs de réussite clé de l'entreprise et le stimulus d'une croissance pondérée et constante dans le temps. Une société moderne et équipée a ainsi pu voir le jour, qui compte aujourd'hui environ 100 employés sur une surface de 15 000 m². Une entreprise de production capable de gérer au mieux l'ensemble de la chaîne de fabrication et de garantir la «qualité du produit». Tumidei est certifiée UNI EN ISO 9001 (qualité), ISO 14001 (environnement), OHSAS 18001 (sécurité).

UNA EMPRESA Y SU TERRITORIO

Nacida en 1958 en Predappio di Romagna, Tumidei tiene tras de sí más de cincuenta años de actividad en una época caracterizada en todo el mundo por un cambio radical en la concepción de la casa, en el modo de vivir de la familia y, por lo tanto, en la decoración. La búsqueda continua de soluciones decorativas cada vez más sofisticadas y en línea con las exigencias del consumidor ha representado uno de los factores de éxito de la empresa y el estímulo para un crecimiento ponderado y constante con el tiempo. Se ha creado una empresa moderna y equipada, que hoy dispone de unos 100 trabajadores y de una superficie de 15.000 m². Una empresa de producción capaz de gestionar mejor toda la cadena de producción y de garantizar la "calidad del producto". Tumidei está certificada según las normas UNI EN ISO 9001 (calidad), ISO 14001 (ambiente), OHSAS 18001 (seguridad).

ФАБРИКА И ЕЁ ТЕРРИТОРИЯ

Основанная в 1958 году в Предапью ди Романья, фабрика Tumidei имеет почти 50-летний опыт работы, который пришелся как раз на тот период, когда во всем мире концепция домашнего очага была радикально переосмыслена, также как и концепция обустройства жилища, а именно мебелировки. Постоянный поиск новых интерьерных решений с одной стороны, а так же, желание удовлетворить все запросы заказчика с другой, являются одной из причин успеха предприятия и стимулом для постоянного роста качества продукции. Родается современное, оснащенное с учетом всех передовых технологий, предприятие, которое на сегодняшний день насчитывает более 120 сотрудников и занимает площадь в 20.000 м2. Это промышленное предприятие полного производственного цикла, что, в свою очередь, является гарантией «высокого качества продукции». У«Tumidei» имеются сертификаты в соответствии с европейскими стандартами Uni En ISO 9001 (качество), ISO 14001 (окружающая среда), OHSAS 18001 (безопасность).

UNA STORIA DI FAMIGLIA

A FAMILY HISTORY

Tumidei's a family company.
Three generations in a flow of growth, changes and passion
in order to always be connected with a constantly evolving
world.

UNE HISTOIRE FAMILIALE

Tumidei est une entreprise familiale.
Trois générations dans une suite de croissance, de
mutation et de passion, dans le but de s'adapter sans
cesse à un monde en évolution constante.



Da sinistra / From left:

Arch. Alexander Bagnai
Gualtiero Tumidei
Fiorella Fiorini
Emanuele Tumidei
Dott. Filippo Fiumana
Lorena Tumidei
Vladimiro Fiumana
Stefano Bagnai

Tumidei un'azienda a conduzione familiare.
Tre generazioni in un susseguirsi di crescita,
mutamento e passione, per allinearsi
costantemente ad un modo in continua evoluzione.

UNA HISTORIA FAMILIAR

Tumidei es una empresa familiar.
Tres generaciones en una sucesión de crecimiento, de
cambio y de pasión, para estar siempre en línea con un
mundo en constante evolución.

ФАБРИКА

Tumidei - это семейный бизнес, уже три поколения работают и
развивают компанию с настоящей страстью и преданностью
делу.

DESIGN & DESIGNERS



MOLTENI&MARELLI

Carlo Marelli e Massimo Molteni aprono lo Studio nel 1977 dopo la laurea in Architettura presso il Politecnico di Milano, realizzando progetti di design industriale, di architettura e di interni, di direzione artistica e di immagine coordinata. Il design per la produzione industriale ha avuto nel tempo come partner aziende prestigiose del settore. Gli incarichi di design e grafica includono complementi d'arredo, mobili per la zona giorno e notte, accessori per mobili, cucine, segnaletica e packaging. Quelli di interior design comprendono allestimenti per show-room, stand fieristici, spazi commerciali e abitazioni. In architettura la progettazione ha interessato edifici di uso pubblico (a carattere civile e religioso), residenze, spazi commerciali e produttivi. Carlo Marelli e Massimo Molteni vivono e lavorano a Cantù.

Carlo Marelli and Massimo Molteni opened their Firm in 1977 having graduated in Architecture from the Polytechnic University of Milan, creating projects for the industrial design, architecture and interior design, artistic direction and coordinated image sectors. In design and graphics, they have worked on furnishing accessories, living room and bedroom furniture, kitchens, signage and packaging. Their interior design work includes showrooms, exhibition stands, commercial and residential areas. In the field of architecture they have created buildings for public use (civil and religious), homes, commercial and production buildings. Carlo Marelli and Massimo Molteni live and work in Cantù.



MARCO FUMAGALLI

Nel 2001 nasce MARCARCHstudio, al centro è lo sviluppo di progetti residenziali. Obiettivo è un'idea del progetto dell'abitare che consenta il superamento dei limiti del tradizionale rapporto end user – designer / architetto. L'impegno è attivo in diversi settori: nell'architettura residenziale e nella progettazione di spazi pubblici. Oggi è un team multidisciplinare con progetti nel settore dell'architettura, product design, interior design, comunicazione, immagine coordinata e direzione artistica. Nel 2010 lo studio vince il "iDot Design Award" e nel 2013- 2014 il "Furniture China Design Award", nel 2015 Good Design Award, Reddot Design Award, IF Design Award e European Consumers Choice Award.

In 2001, the Architect Marco Fumagalli founded MARCARCHstudio. Residential architecture is at the centre of developing projects. The aim is an idea of a living design that lets the traditional relationship between user and architect override its limits. Sectors of the design of arrangements, showrooms and public spaces are being developed. Today, it has a multi-disciplinary team that results in approaches in different sectors: architecture, product design, interior design, communication, branding, corporate identity studies and art direction. In 2010 the Studio won the "iDot Design Award", in 2013-2014 won the "Furniture China Design Award". In 2015 Good Design Award, Reddot Design Award, IF Design Award and European Consumers Choice Award, in 2016 won the "Best touch and feel" Star Property Award Malaysia on Lumi development ID project, 2017 Reddot Design Award.



SIMONE CAGNAZZO

Simone Cagnazzo, classe 1978, si diploma al liceo artistico, successivamente studia design e comunicazione all'Università del progetto di Reggio Emilia. Partito dal product design e dall'interior design nel 2008 inizia la propria carriera indipendente aprendo il proprio studio a Modena coordinando progetti di Art direction e negli anni lo studio sviluppa competenze in diversi settori grazie ad un approccio integrato e strategico all'Art Direction. Oggi lo Studio Cagnazzo è composto da un team di professionisti del design e della comunicazione coordinato direttamente da Simone. Lo studio risponde prontamente alle specificità di ogni cliente e alle differenti scale di progetto.

Simone Cagnazzo, born in 1978, graduated from art school, then studied design and communications at the "Università del Progetto" in Reggio Emilia. Starting with product and interior design, Simone starts his career as self-employed architect by opening his firm in Modena, coordinating projects of Art Direction; through the years, his Firm develops competencies in different sectors thanks to an integrated and strategic approach to Art Direction. Today the Simone Cagnazzo Firm has a team of professionals in design and communication, lead directly by Simone himself. The Firm can satisfy the specific needs of each customer, in projects of different sizes.

UNA REALTÀ INTERNAZIONALE

A Tokyo come a Chicago, a Buenos Aires come a Mosca le qualità italiane vengono esaltate attraverso le eccellenze che da secoli sono esportate in tutto il mondo: cibo, arte, moda, ma non solo. Lo stile Tumidei, che coniuga una concezione artigianale del lavoro a una vision imperniata di modernità, è stata la chiave d'accesso per diffondersi in 50 Paesi di tutti i cinque Continenti.

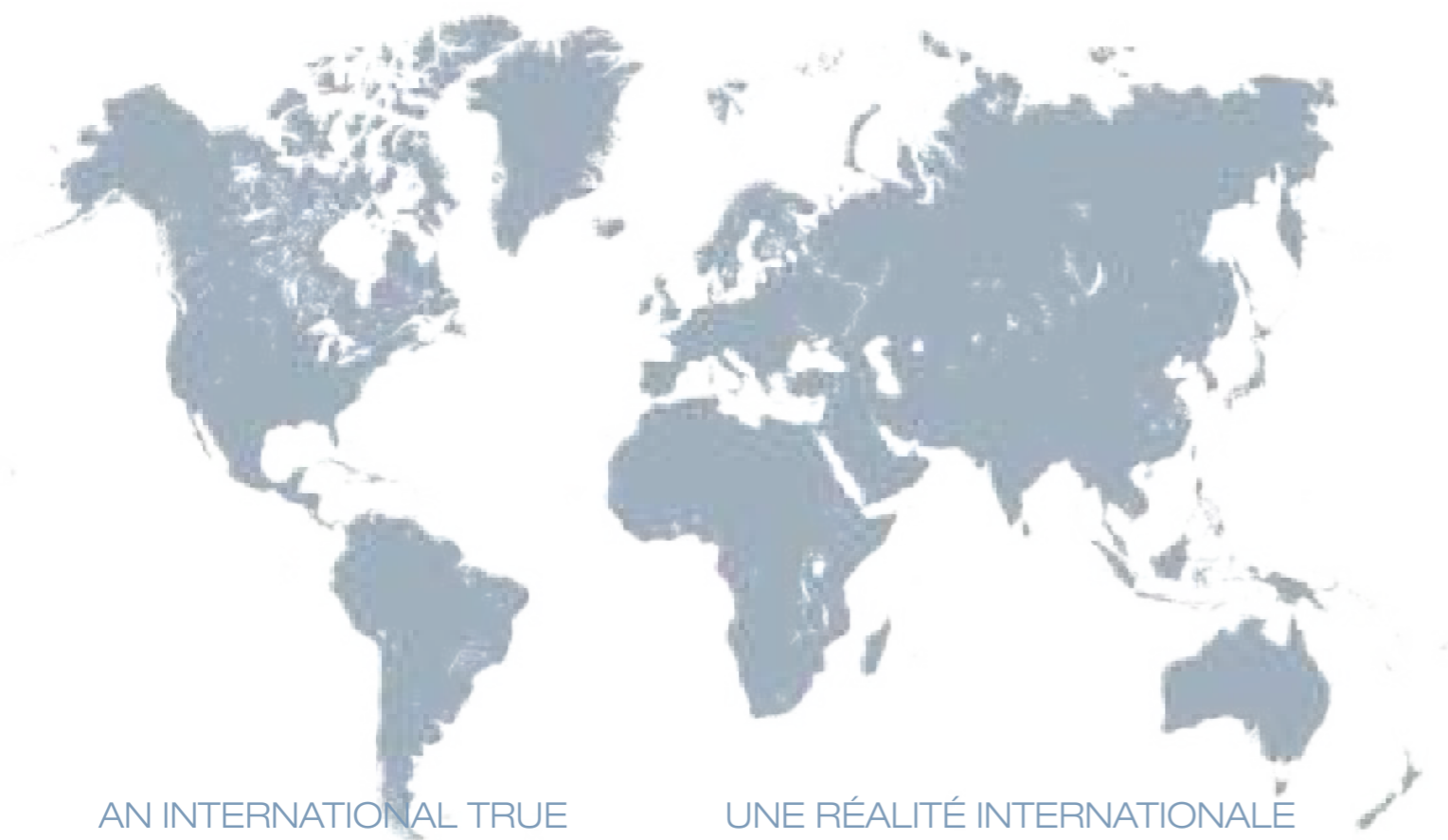

AN INTERNATIONAL TRUE

In Tokyo or in Chicago, in Buenos Aires or in Moscow: Italian qualities are recognized all over the world through the excellent products that have been exported for centuries: food, art and fashion, among others. Tumidei's style, combining craftsmanship and a state-of-the-art vision, has been the key to the Company's diffusion in over 50 countries in all 5 Continents.

UNA REALIDAD INTERNACIONAL

En Tokio, como en Chicago, Buenos Aires o Moscú, se ensalzan las cualidades italianas mediante las excelencias que, desde hace siglos, son exportadas a todo el mundo: comida, arte, moda, pero no sólo eso. El estilo Tumidei, que conjuga una concepción artesanal del trabajo con una visión impregnada de modernidad, fue la llave de acceso para expandirse y difundirse a más de 50 países de los cinco continentes.

UNE RÉALITÉ INTERNATIONALE

À Tokyo comme à Chicago, à Buenos Aires comme à Moscou, la qualité italienne se décline dans les produits d'excellence exportés depuis des siècles dans le monde entier : la nourriture, l'art, la mode bien sûr mais pas seulement. Le style Tumidei, qui conjugue conception artisanale du travail et perspective axée sur la modernité a été notre clé d'accès à 50 pays aux quatre coins du globe.

РЕАЛЬНОСТЬ НА МЕЖДУНАРОДНОМ УРОВНЕ

В Токио как и в Чикаго, в Буэнос-Айресе, как и в Москве, итальянское качество славится благодаря своей продукции, которая экспортируется по всему миру на протяжении веков: кухня, искусство, мода, и не только. Стиль Tumidei, который сочетает в себе концепцию ручной работы и современное видение, послужил ключом для выхода на рынок в 50 странах на пяти континентах.

IL RAPPORTO CON L'AMBIENTE

La Tumidei nell'anno 2006 ha ottenuto la certificazione UNI EN ISO 14001. Strumento di gestione volontario, riguardante l'ambiente che sta a testimoniare da parte della Tumidei un profondo rispetto per l'ambiente, la salvaguardia delle risorse naturali, il corretto utilizzo delle materie prime ed il risparmio energetico. Tumidei ha realizzato un impianto fotovoltaico di potenza complessiva di 700 kWp su di una area complessiva di 11.350 metri quadrati che immetterà "ENERGIA ELETTRICA SOLARE" direttamente negli impianti di produzione per far sì che oltre il 70% del fabbisogno energetico venga soddisfatto nell'assoluto rispetto ambientale. Vengono inoltre utilizzati legni che provengono da coltivazioni ecosostenibili, a basso contenuto di formaldeide e finiti con vernici all'acqua con barriere igienizzanti antibatteriche.



OUR RELATIONSHIP WITH THE ENVIRONMENT

Tumidei is a uni en iso 14001 certified company since 2006. This certification is a voluntary set of standards which Tumidei has used to design and implement an effective environmental management system, testifying its respect for the environment, the preservation of natural resources, the fair use of raw materials and energetic saving. Tumidei installed a photovoltaic system of 700 kwip on a total area of 11.350 M². This system will produce "SOLAR ELECTRICAL ENERGY" for the production plant and equipments, meeting 70% of the company's energetic needs. Furthermore we use wood coming from eco-sustainable cultivated land, with a low-formaldehyde content and lacquered with water-based paints with anti-bacterial barriers.

PRIORITÉ À L'ENVIRONNEMENT

La société Tumidei a obtenu en 2006 la certification UNI EN ISO 14001. Outil de gestion volontaire en matière d'environnement, elle illustre le profond respect que l'entreprise accorde à l'environnement, à la protection des ressources naturelles, au bon usage des matières premières et aux économies d'énergie. Tumidei a réalisé une installation photovoltaïque d'une puissance globale de 700 kWp sur un espace total de 11 350 mètres carrés en vue de fournir de « L'ÉNERGIE SOLAIRE ÉLECTRIQUE » directement aux installations de production de manière à ce que plus de 70 % de ses besoins énergétiques soient satisfaits dans le respect le plus absolu de l'environnement. Nous utilisons également du bois provenant de cultures forestières respectueuses de l'environnement, à faible contenu en formaldéhyde et dont les finitions sont effectuées en utilisant des vernis à l'eau à barrières hygiénisantes antibactériennes.

UNA RELACIÓN CON EL MEDIO AMBIENTE

La empresa Tumidei obtuvo en el año 2006 el certificado UNI EN ISO 14001. Instrumento de gestión voluntario, referente al medio ambiente y que testimonia por parte de Tumidei un profundo respeto por el medio ambiente, la salvaguardia de los recursos naturales, la correcta utilización de las materias primas y el ahorro energético. La empresa Tumidei ha realizado una instalación fotovoltaica de una potencia global de 700 kWp en una área total de 11.350 metros cuadrados que introducirá "ENERGÍA ELÉCTRICA SOLAR" directamente en las instalaciones de producción para hacer que se satisfaga más del 70% de la demanda energética con el respeto más absoluto del medio ambiente. Además, se utilizan leñas que proceden de cultivaciones sostenibles ecológicamente, con bajo contenido de formaldehído y acabados con barnices al agua con barreras higienizantes antibacterianas.

ВЗАИМОСВЯЗЬ С ОКРУЖАЮЩЕЙ СРЕДОЙ

Добровольный выбор системы управления, затрагивающей окружающую среду, со стороны Tumidei, является свидетельством проявления абсолютного уважения по отношению к окружающей среде, сохранению природных ресурсов, рациональному использованию сырья и энергообережению. Tumidei использует фотоэлектрические станции общей мощностью 700 кВт, размещаемые на общей площади в 11.350 квадратных метров и поставляющие "солнечное электричество" непосредственно в производственные цеха, что удовлетворяет 70% потребности в энергии с абсолютным уважением к окружающей среде.

Il "Sistema integrato" QUALITÀ-AMBIENTE-SICUREZZA

È con grande orgoglio da parte della Direzione, che TUMIDEI ha raggiunto questo traguardo che ad oggi risulta essere, per il settore legno e arredamento, tra le prime certificazioni integrate, emesse dall'Ente di certificazione ICILA marchio di CSI s.p.a. (Gruppo IMQ), ottenendo inoltre il certificato di "ECCELLENZA" rilasciato dall'ente stesso, che sta a testimoniare l'impegno dell'organizzazione a gestire in modo sistematico e secondo modelli standard internazionali riconosciuti, aspetti organizzativi rilevanti e complessi, cioè l'efficacia, l'efficienza, l'impatto ambientale, la salute e la sicurezza dei lavoratori, il trattamento responsabile dei collaboratori, nell'ottica del miglioramento continuo delle prestazioni e dell'impatto sociale delle attività dell'organizzazione. Tumidei utilizza pannelli con certificazione CARB Phase 2, in vigore dal 01/01/2011, che assicura emissioni di formaldeide inferiori a 0.09 ppm.



"Integrated system" QUALITY-ENVIRONMENT-SECURITY

Tumidei's board is very proud to have achieved this target, also because as of today this is one of the first certifications issued by the ICILA INSTITUTION, brand of CSI s.p.a. (IMQ group) within the wood and furniture sector, to a Company dedicated to home design furnitures. The certification authority has also awarded Tumidei with a certificate of "EXCELLENCE", for its commitment to systematically manage all relevant and complex aspects of the organization (such as effectiveness, efficiency, environmental impact, the workers' health and safety and the fair treatment of co-workers) according to the international standards, towards the continuous improvement of performances and social impact of the Company's activities. Tumidei uses CARB Phase 2 certified panels, in force since 01/01/2001, that ensures formaldehyde emissions below 0.09 ppm.

"Système intégré" QUALITÉ-ENVIRONNEMENT-SÉCURITÉ

C'est avec une grande fierté que la direction de l'entreprise a atteint cet objectif qui, à l'heure actuelle dans le secteur du bois et de l'ameublement, reste l'une des premières certifications remises par l'Organisme de certification ICILA brand CSI s.p.a. (Group IMQ) à une société spécialisée dans le mobilier domestique. Cet organisme nous a également décerné un autre certificat d'«EXCELLENCE» qui illustre la volonté de l'entreprise de gérer de manière systématique et selon des modèles internationaux normalisés et reconnus des aspects structurels importants et complexes à savoir l'efficacité, les performances, l'impact environnemental, la santé et la sécurité des travailleurs ainsi que le traitement responsable des collaborateurs dans la perspective de l'amélioration continue des prestations et de l'impact social de l'activité de notre société.

Tumidei utilise panneaux avec certification CARB Phase 2, en vigueur de 01/01/2011, qu'elle assure émissions de formaldéhyde inférieurs à 0.09 ppm.

"Sistema integrado" CALIDAD-AMBIENTE-SEGURIDAD

Es con gran orgullo por parte de la Dirección de la Empresa tras haber alcanzado esta meta que hoy resulta estar, para el sector de la madera y decoración, entre los primeros certificados emitidos por el ente certificador ICILA marca CSI s.p.a. (Grupo IMQ) con respecto a una Empresa del sector de decoración de casas. Además, el Ente certificador expide otro certificado denominado "EXCELENCIA" que testimonia el compromiso de la organización para gestionar de manera sistemática y según los modelos estándar internacionales reconocidos, aspectos organizativos relevantes y complejos, es decir, la eficacia, la eficiencia, el impacto ambiental, la salud y la seguridad de los trabajadores, el trato responsable de los colaboradores con vistas a la mejora continua de las prestaciones y del impacto social de la actividad de la organización.

Tumidei utiliza paneles con certificación CARB Phase 2, en vigor del 01/01/2011, que asegura emisiones de formaldehído inferior a 0.09 ppm.

«Система Интеграции» КАЧЕСТВО-ОКРУЖАЮЩАЯ СРЕДА-БЕЗОПАСНОСТЬ

Достижение этого рубежа, к большой гордости Управления Tumidei, в секторе производства и обработки древесины и мебели, сегодня является одной из первых интегрированных сертификаций, выданных Органом по сертификации ICILA входящая в состав компании CSI s.p.a. (Gruppo IMQ), а также получение сертификата „ ECCELLENZA „, предоставленное тем же самым Органом, является свидетельством стараний организации в управлении с постоянством и в соответствии с признанными международными стандартами, весомыми и сложными организационными аспектами, такими как эффективность, продуктивность, воздействие на окружающую среду, здоровье и безопасность трудящихся, ответственное отношение к сотрудникам, с целью постоянного повышения производительности и социального влияния деятельности организации.

Tumidei с 01/01/2011 использует в производстве мебели сертифицированные панели CARB Phase 2, гарантирующие эмиссию формальдегида ниже 0.09 мг/м3.



ISO 9001=Qualità

Poniamo particolare attenzione nella scelta di materie prime atossiche e a bassa emissione di formaldeide perché la tutela della salute di chi usa i nostri prodotti e dei nostri collaboratori è una priorità inderogabile. Ogni giorno lavoriamo per mantenere ed aumentare la fiducia dei clienti, l'impegno per la qualità serio e costante della Tumidei è testimoniato dalla certificazione ISO 9001 e dalle verifiche periodiche degli Ispettori dell'Ente di Certificazione ICILA brand di CSI s.p.a. (Gruppo IMQ), sicuri che "fare bene" sia l'arma vincente per il mercato di oggi e di domani.

ISO 9001=Quality

We care especially about the choice of non-toxic materials and low formaldehyde emission raw materials because we care about the health of those who use our products and those who work with us. Every day we work for increasing our clients' trust, our constant and serious commitment for quality is testified by the ISO 9001 certification and by the frequent inspections by the certification authority ICILA brand CSI s.p.a. (Gruppo IMQ) supervisors. We believe that "working well" is the best way to work in today's and tomorrow's market.

ISO 9001=Qualité

Nous mettons une attention particulière dans le choix de matières premières atoxiques et à bas contenu de formaldéhyde parce que la tutelle de la santé de ceux qui emploient nos produits et de nos collaborateurs est une priorité inéluctable. Nous travaillons chaque jour pour garder et accroître la confiance des clients ; l'engagement sérieux et constant de la société Tumidei pour la qualité est attesté par la certification ISO 9001 et par les vérifications périodiques des Inspecteurs de l'Organisme de certification ICILA brand CSI s.p.a. (Gruppo IMQ), et nous sommes convaincus que "bien faire" est la formule gagnante pour le marché d'aujourd'hui et de demain.

ISO 9001=Calidad

ponemos particular atención en la selección de las materias primas atóxicas (barnices al agua sin solventes peligrosos) y al bajo contenido de formaldeído (paneles en Clase E1) porque la tutela de la salud de los que utilizan nuestros productos y de nuestros colaboradores es una prioridad inderogable. Cada día trabajamos para mantener y aumentar la confianza de los clientes, el compromiso por una calidad seria y constante de Tumidei se representa mediante el certificado ISO 9001 y las comprobaciones periódicas del Ente Certificador ICILA brand CSI s.p.a. (Gruppo IMQ), seguros de que "trabajar bien" sea el elemento ganador para el mercado de hoy y de mañana.

ISO 9001=Качество

Мы уделяем особое внимание выбору нетоксичного сырья с низким содержанием формальдегида, заботясь о здоровье тех, кто пользуется нашей продукцией, и тех, кто ее производит, что является нашей неоспоримой прерогативой. Каждый день мы работаем для того, чтобы сохранить и усилить доверие наших клиентов, ответственность и обязательство по сохранению высокого качества TUMIDEI подтверждено сертификатом ISO 9001 и периодическими контролями со стороны инспекторов Института Сертификации ICILA входящая в состав компании CSI s.p.a. (Gruppo IMQ), и мы уверены в том, что «делать хорошо» это оружие, позволяющее нам побеждать на рынке сегодняшнего и завтрашнего дня.

OHSAS 18001=Sicurezza

Il conseguimento della certificazione del proprio Sistema di Gestione per la Sicurezza e la Salute del Lavoro, rilasciata da ICILA brand di CSI s.p.a. Gruppo IMQ, in conformità alla specifica OHSAS 18001, costituisce ampia garanzia dell'impegno profuso dalla Tumidei al fine di controllare e gestire al meglio i rischi per la sicurezza e la salute connessi con le attività lavorative, favorendone la minimizzazione in un'ottica di miglioramento continuo che si fonda sul coinvolgimento, sulla sensibilizzazione, sulla consapevolezza e sulla formazione di tutto il personale coinvolto, dipendente ed esterno.

OHSAS 18001=Security

The OHSAS 18001 certification of a Company's health and safety management systems issued by ICILA brand CSI s.p.a. (Gruppo IMQ) is a certain warranty for Tumidei's engagement for controlling and managing at its best the health and safety risks associated to working operations, aiming at their reduction and at continuous improvement by involving, raising commitment and awareness of all inhouse staff and contractors involved in the production process.

OHSAS 18001=Sécurité

L'obtention de la certification de son Système de Gestion pour la Sécurité et la Santé du Travail, délivrée par ICILA brand CSI s.p.a. (Gruppo IMQ) conformément au détail OHSAS 18001, constitue une vaste garantie de l'engagement abondant de TUMIDEI au fin de contrôler et gérer au mieux les risques pour la sécurité et la santé joints avec les activités ouvrables en favorisant sa minimisation dans un but d'amélioration continue qui se base sur l'implication, sur la sensibilisation, sur la prise de conscience et sur la formation du personnel concerné, salarié et extérieur.

OHSAS 18001=Seguridad

El logro de la certificación del propio sistema de gestión para la seguridad y la salud del trabajo emitido por la ICILA brand CSI s.p.a. (Gruppo IMQ) de acuerdo con la especificación OHSAS 18001, constituye una amplia garantía del compromiso hecho de la tumidei con el fin de controlar y dirigir mejor posible los riesgos para la seguridad y la salud relacionados con las actividades del trabajo favoreciendo la minimización con vistas a una mejora continua que se basa en la implicación, la sensibilización, la conciencia y la formación de todo el personal implicado, dependiente y externo.

OHSAS 18001=Безопасность

Получение сертификации собственной Системы Управления по безопасности и охране здоровья трудящихся, предоставленной ICILA входящая в состав компании CSI s.p.a. (Gruppo IMQ), в соответствии с OHSAS 18001, дает уверенную гарантию исполнения взятого TUMIDEI обязательства по контролю и управлению наилучшим образом аспектов безопасности и охраны здоровья трудящихся, связанных с производством, способствующей минимизации с целью постоянного улучшения на основе вовлечения, сенсбилизации, сознательности, профессиональной подготовки внутреннего работающего персонала, а так же внешних сотрудников.

ISO 14001=Ambiente

La Tumidei con l'ottenimento della certificazione del proprio Sistema di Gestione Ambientale, rilasciata da ICILA brand di CSI s.p.a. (Gruppo IMQ), in conformità alla normativa internazionale ISO 14001, dimostra di aver raggiunto e di mantenere un comportamento ecologicamente compatibile mediante il continuo controllo degli aspetti (cause) e degli impatti (effetti) ambientali connessi alle proprie attività e prodotti.

ISO 14001=Environment

By certifying its environmental management system by the certification authority ICILA brand CSI s.p.a. (Gruppo IMQ) according to the iso 14001 standards, Tumidei demonstrates that reaching and maintaining an eco-friendly behaviour, through the continuous controls of environmental aspects (causes) and impacts (effects) involved in its production and activities, is one of its main goals. the certification has been issued by icila(the leader certification authority for the wood and design sector).

ISO 14001=Environnement

La TUMIDEI avec l'obtention de la certification de son Système de Gestion Environnementale, délivrée par ICILA brand CSI s.p.a. (Gruppo IMQ), conformément à la réglementation internationale ISO 14001, montre d'avoir rejoint et de maintenir un comportement écologiquement compatible par des contrôles continus des aspects (causes) et des impacts (effets) de l'environnement liés à ses activités et produits.

ISO 14001=Ambiente

La Tumidei con el logro de la certificación del propio sistema de gestión ambiental, emitido por la ICILA brand CSI s.p.a. (Gruppo IMQ), en cumplimiento con las normas internacionales ISO 14001 demuestra de haber obtenido y de mantener una conducta ecologicamente compatible mediante el continuo control de los aspectos (causas) y de los impactos (efectos) ambientales relacionados a las propia actividad y productos.

ISO 14001=окружающая среда

Получение Tumidei сертификации собственной Системы управления воздействием на окружающую среду, от института ICILA входящая в состав компании CSI s.p.a. (Gruppo IMQ), в секторе производства и обработки древесины и мебели, в соответствии с международным нормативом ISO 14001, доказывает достижение и соблюдение экологически совместимого поведения, посредством постоянного контроля аспектов (причин) и воздействия (эффектов) на окружающую среду от деятельности собственного производства и производимой продукции.



PERCHÉ “TIRAMOLLA”?

Per la Versatilità: comporre all'infinito senza limiti attraverso una struttura di tubi e trafilati in alluminio liberando la fantasia con l'utilizzo di numerose finiture. Per la progettualità e la fantasia: progetti al centimetro.

Tubi e trafilati, piani e mensole, vengono tagliati con dimensioni e forme che più ti aggradano, anche su vostro disegno. Ti potrai divertire a decorare con una personalizzazione unica i tuoi mobili attraverso la stampa digitale di ante e pannelli utilizzando vernici ecologiche e abbinandole a decorazioni murali su carte in fibra di vetro stampate con inchiostri atossici “Greenguard” per creare ambienti unici coordinati. E poi tanti motivi ancora per la tua scelta: dagli ecopannelli a basso contenuto di formaldeide, alle vernici ad acqua con delle speciali barriere antibatteriche, tutte le nostre certificazioni per i collaudi di soppalchi, aperture di cassette e cerniere, bordi resistenti all'acqua.

Se vuoi saperne di più sulla nostra qualità scarica dal nostro sito il catalogo “ABOUT US”.

WHY “TIRAMOLLA”?

For the Versatility: composing endlessly with no limits, through a tubular structure and contours in aluminium, letting fantasy loose with the use of many finishes. For modularity and fantasy: projects made to the centimetre. Tubes and profiles, tops and shelves are cut in the sizes and shapes that you prefer, also upon your drawing. You can have fun decorating your furniture as you like, through the digital print of doors and panels using ecological paints and matching them to wall decorations on papers in glass fibers printed with “Greenguard” non-toxic inks, to create unique coordinated environments. There are also many other reasons to choose us: the eco-panels with low content of formaldehyde, water-based paints with special anti-bacterial barriers, all our certifications for mezzanines testing, opening of drawers and hinges, water-resistant borders. If you want to find out more on our quality, download the “ABOUT US” leaflet from our website.

POURQUOI “TIRAMOLLA”?

Pour la polyvalence: composer à l'infini et sans limites grâce à une structure de tubes et de profils en aluminium qui donne libre cours à l'imagination avec nombreux finitions.

Pour la conceptualité et l'imagination: des projets au centimètre. Tubes et profils, plateaux et tablettes: tous sont découpés dans les dimensions et les formes que vous préférez et même, si vous le souhaitez, d'après votre projet. Vous pourrez vous amuser à décorer vos meubles en les personnalisant de manière unique grâce à l'impression numérique des portes et des panneaux avec des vernis écologiques ou en les associant à des décorations murales sur du papier en fibre de verre imprimé avec des encres atoxiques «Greenguard» pour créer des environnements coordonnés sans pareil. Mais les raisons de nous choisir ne s'arrêtent pas là et en voici d'autres: nos éco-panneaux à faible contenu en formaldéhyde, nos vernis à l'eau avec barrières antibactériennes spéciales ainsi que toutes nos certifications relatives aux essais des mezzanines, aux ouvertures de tiroirs et de charnières et aux bords résistants à l'eau.

Si vous souhaitez en savoir plus sur la qualité de nos produits, veuillez télécharger la brochure «ABOUT US» sur notre site.

POR QUÉ “TIRAMOLLA”?

Por la Versatilidad: componer sin límites a través de una estructura de tubos y trellados de aluminio liberando la fantasía con el uso de numerosos acabados.

Para el proyecto y la fantasía: proyectos realizados al centímetro. Tubos y trellados, planos y repisas, se cortan con las dimensiones y formas que más te gustan, también con tu diseño. Te podrás divertir decorando con una personalización única tus muebles mediante la impresión digital de puertas y paneles utilizando barnices ecológicos y combinándolos con decoraciones murales en papel de fibra de vidrio estampadas con tintas no tóxicas “Greenguard” para crear ambientes únicos coordinados. Además, muchos otros motivos para tu elección: desde los paneles ecológicos con bajo contenido de formaldehído, a los barnices al agua con barreras antibacterianas especiales, todos nuestros certificados para las pruebas de altillos, aperturas de cajones y bisagras, bordes resistentes al agua. Si quieres saber más sobre nuestra calidad, descarga desde nuestro sitio web el fascículo “ABOUT US”

ПОЧЕМУ “TIRAMOLLA”?

Гибкость: проектировать до бесконечности без ограничений с помощью системы труб и алюминиевых профилей, освобождая фантазию через многочисленные отделки.

Проектирование и фантазия: проекты до сантиметра. Трубы и профили, столешницы и полки, изготавливаемые полностью под размер и желаемую форму, даже по Вашему рисунку. Получайте удовольствие, декорируя уникальной персонализацией вашу мебель, благодаря цифровой печати на дверках шкафов и панелях, с использованием экологических красок и сочетая их с декоративными обоями из стекловолокна, печать на которых произведена нетоксичными красками “Greenguard” для создания уникальных координированных интерьеров. А также ряд других причин для Вашего выбора: от экопанелей с низким содержанием формальдегида, до красок на водной основе, создающих антибактериальные барьеры, сертификация на основе испытаний на прочность подиумов, открытия ящиков и петель, водостойкость канта. Если вы желаете узнать больше про наше качество, скачайте с нашего веб-сайта брошюру «ABOUT US»



OOOOOOOOOOOO
OOOOOOOOOOOO

CREA IL TUO STILE

Nativi digitali, social per natura, nomadi per istinto: ecco lo stile dei giovani del nuovo millennio. Per loro occorrono spazi dinamici, sempre connessi e votati alla libertà assoluta. La risposta è Tiramolla, un progetto capace di stare sempre al passo con i tempi e di trasformarsi in base ai gusti e alle esigenze. Lo stile è tutto da inventare, nordico minimal, romantico decor, urban contemporaneo, un unico mondo, moltissimi stili.

CREATE YOUR STYLE

Digital natives, naturally social, instinctively globe-trotters: this is the new-millennium youngsters' style. They need dynamic spaces, always connected and designed for the absolute freedom. Tiramolla is the answer: a project able to always be in line with the times and able to change itself following different tastes and needs. Style is all to be invented: Nordic minimal, romantic décor, contemporary urban. One world, many different styles.

CREE TON STYLE

Numériques innés, sociaux par nature, nomades par instinct : voilà le style des jeunes gens du nouveau millénaire. Pour eux, il faut des espaces dynamiques et destinés à leur liberté absolue. Tiramolla est la réponse, soit un projet capable d'évoluer avec les temps et de s'adapter selon les goûts et les exigences. Un style tout à inventer, nordique minimal, romantique, urbain contemporain, un seul monde, beaucoup de styles.

CREA TU ESTILO

Nativos digitales, sociales por naturaleza, nómades por instinto: eso es el estilo de los jóvenes del nuevo milenio. Para ellos sirven espacios dinámicos y destinados a su libertad absoluta. Tiramolla es la respuesta, un proyecto capaz de avanzar con los tiempos y de convertirse según los gustos y las exigencias. Un estilo todo que inventar, nórdico minimal, romántico, urbano contemporáneo, un único mundo, muchos estilos.

СОЗДАЙ СВОЙ СТИЛЬ

Поколение диджитал, общительные по своей натуре, со страстью к путешествиям - это стиль молодежи нового тысячелетия. Для них необходимы динамичные пространства, предоставляющие полную свободу. Ответ - Tiramolla, проект, который идет в ногу со временем, и соответствует потребностям и образу жизни молодежи. Большие возможности составления композиций, бесконечный выбор персонализированных решений в концепции "smart". Один мир - множество стилей.

DECOR / ROMANTIC STYLE



CONTEMPORARY / URBAN STYLE



6/9 years



LET'S PLAY



11Y

UN PERCORSO DI CRESCITA

Tiramolla è fatto su misura per i giovani di oggi e di domani, perché cresce con loro attraverso una collezione dove trovano posto letti a scomparsa, armadi sotto i letti, ante e pareti personalizzate con stampe digitali, dispositivi wireless e accessori 4.0. Ogni progetto nasce per rispondere alle necessità di un percorso di crescita, dal gioco al lavoro attraverso le diverse età dello studio. Componibile a piacere, personalizzabile all'infinito, iperhitech con un occhio allo stile: in una parola "smart".

GROWING WITH YOU

Tiramolla is designed for the youngsters of today and tomorrow as it grows up with them through a collection where pull-out beds, wardrobe built under the beds, doors and bookshelves tailored with digital prints, wireless devices and 4.0 accessories can be found. Every project is made to respond to growing up needs, from game to work throughout the different school ages. Modular, endlessly customizable, extremely hi-tech, focused on style: in one word "smart".

ON GRANDIT AVEC TOI

Tiramolla est fait sur mesure pour les jeunes d'aujourd'hui et de demain parce qu'il grandit avec eux à travers une collection où des lits escamotables, des armoires au-dessous des lits, des portes et des parois décorés d'impressions numériques, des appareils sans fil et des accessoires 4.0 prennent leur place. Chaque projet naît pour répondre aux exigences d'une entière trajectoire de croissance, du jeu au travail en passant par les différentes étapes d'étude. Modulaire, à personnaliser sans cesse, iperhitech, avec un accent sur le style : en un mot « smart ».

CRECEMOS JUNTOS

Tiramolla está hecho a medida para los [...] toman su asiento. Cada proyecto nace para satisfacer las necesidades de toda una trayectoria de crecimiento, desde el juego hasta el trabajo pasando através de las varias fases de estudio. Modular, siempre personalizable, iperhitech, con una atención especial hacia el estilo: en una palabra, "smart".

РАЗВИВАЕМСЯ ВМЕСТЕ С ВАМИ

Tiramolla creata special pentru tinerii de azi si de maine, deoarece creste impreuna cu ei printr-o colectie in care gasesc loc paturi retractabile, dulapuri sub paturi, usi si pereti personalizate cu imprimeuri digitale, dispozitive wireless si accesorii 4.0. Fiecare proiect este conceput pentru a raspunde la nevoile unui proces de dezvoltare, de la joaca la munca printr-un proces de studiu. Modular, personalizabil la nesfarsit, iperhitech, cu un accent pe stil: intr-un cuvant "smart".

18^Y



LET'S STUDY

LET'S WORK



21^Y



14^Y

LET'S THINK



25/30^{years}

#FASHION GIRL

SOPPALCHI CON TRAFILA
Mezzanines with profiles



CONFIGURATION

301





Configuration 301

DESCRIZIONE TECNICA / TECHNICAL DATA

Q.TA Q.TY	CODICE CODE	A / H	L / W	P / D	DESCRIZIONE / DESCRIPTION
2	EZ43	106,0	3,0	31,6	Supporto metallico per 3 mensole / Metal support for 3 shelves
1	GT08	220,4	8,0	8,0	Tubo quadro 8x8 cm per piani accoppiati con piastra e livellatore / Intermediate square tube 8x8 cm for joint tops with plate and level adjuster
1	GT12	220,4	8,0	8,0	Tubo quadro 8x8 cm angolare con piastra e livellatore / Angular square tube 8x8 with plate and level adjuster
4	KBR43	2,8	111,5	46,2	Mensola lineare per cremagliera / Linear shelf for rack
1	KK9I	68,0	111,5	46,2	Cassettiera interna con 3 cassetti e 2 ripiani / Inner chest of drawers with 2 drawers and 2 shelves
1	LB61	32,0	100,0	200,0	Letto singolo con trafila scorrevole su ruote unidirezionali / Single bed with sliding profiles and one-way castors
7	LB7A	2,8	52,8	27,9	Ripiano per vano scala / Shelf for stair section
4	LB7C	2,8	50,0	57,8	Ripiano per vano scala / Shelf for stair section
1	LBX6V	178,4	250,2	62,6	Scala a composizione / Stair
5	LQ03	219,7	47,1	2,0	Pannello di chiusura con angolare su filo interno tubi / Closing panel with corner bracket
2	LQ06	219,7	111,5	2,0	Pannello di chiusura con angolare su filo interno tubi / Closing panel with corner bracket
2	LQ09	219,7	114,2	2,0	Pannello di chiusura con angolare su filo interno tubi / Closing panel with corner bracket
1	LS03V	219,3	57,0	2,0	Pannello di chiusura verticale per soppalco / Vertical closing panel for mezzanine
1	LSA3ML	219,1	54,2	2,0	Anta battente singola per chiusura vano sotto soppalco (m.) / Single hinged door for mezzanine closure (mtl.)
2	LSA3ML	219,1	55,5	2,0	Anta battente singola per chiusura vano sotto soppalco (m.) / Single hinged door for mezzanine closure (mtl.)
1	LW07X	73,0	99,5	211,0	Letto SYSTEM STAR singolo imbottito fisso con testata e schiena H.58.5 cm / SYSTEM STAR upholstered single fixed bed with headboard and back H.58.5 cm
5	MGLMQ5T	36,8	106,0	2,0	Maggiorazione laccatura schiena / Supplement for lacquered back
1	MGT3	219,3	57,0	2,0	Maggiorazione per livellatore e predisposizione per fissaggio a trafila / Supplement for level adjuster and set up for profiles fixing
1	MP31	24,5	50,0	54,5	Scala angolare con 1 gradino / Corner stair with 1 step
1	MP96	22,0	50,0	56,5	Pedana con cassetto / Base with drawer
1	MP97	22,0	100,0	56,5	Pedana con cassetto / Base with drawer
3	MQA47	40,8	110,0	31,1	Elemento pensile orizzontale con 3 vani a giorno e 1 anta doppia / Horizontal wall box with 3 open sections and 1 double door
2	MQA48	40,8	110,0	31,1	Elemento pensile orizzontale con 3 vani a giorno e 1 anta doppia / Horizontal wall box with 3 open sections and 1 double door
2	PR3P	90,0	51,5	2,0	Protezione per scale in policarbonato trasparente / Protection for stairs in transparent polycarbonate
3	PR3Q	90,0	114,0	2,0	Protezione per scale in policarbonato trasparente / Protection for stairs in transparent polycarbonate
3	PX28LL	4,0	80,0	0,2	Maniglia ad incasso rettangolare con fondo e bordo laccato / Recessed rectangular handle with lacquered back and edge
1	S301A	223,4	250,0	125,0	Sistema trafila per soppalco / Profiles system for mezzanine
1	S301B	223,4	250,0	125,0	Sistema trafila per soppalco / Profiles system for mezzanine
1	S301C	223,4	250,0	60,6	Sistema trafila per soppalco / Profiles system for mezzanine
1	SE72	90,5	65,0	65,0	Sedia con ruote e regolabile in altezza con scocca in legno e basamento in metallo / Chair on castors adjustable in height with wooden structure and metal base
1	SE79	90,5	65,0	65,0	Seduta imbottita sfoderabile per SE72 e SE76 / Upholstered and removable seat for SE72 and SE76
3	TB94	6,5	111,0	2,0	Tubo appendiabiti in alluminio / Linear hanging rail in aluminium
1	TE08	50,0	98,0	10,0	Testata imbottita sfoderabile / Upholstered and removable headboard
1	TQ34	77,2	166,6	59,2	Scrivania spessore 4 cm predisposto per aggancio a muro o pannello con 1 gamba telaio in metallo / Desk thickness 4 cm set up for fixing onto wall or panel with 1 metal frame leg
1	UV99	100,0	508,9	0,1	Stampa digitale su pannello con immagine archivio Tumidei o cliente / Digital print on panel with image from Tumidei' library or from customer
2	VS23	40,0	40,0	20,5	Mensola T-BOX L 40 cm / T-BOX shelf W 40 cm
4	VS24	20,0	43,5	20,5	Mensola T-BOX L 43.5 cm / T-BOX shelf W 43.5 cm
1	VS25	20,0	56,5	20,5	Mensola T-BOX L 56.5 cm / T-BOX shelf W 56.5 cm

INGOMBRI / DIMENSIONS

CONFIGURATION

301

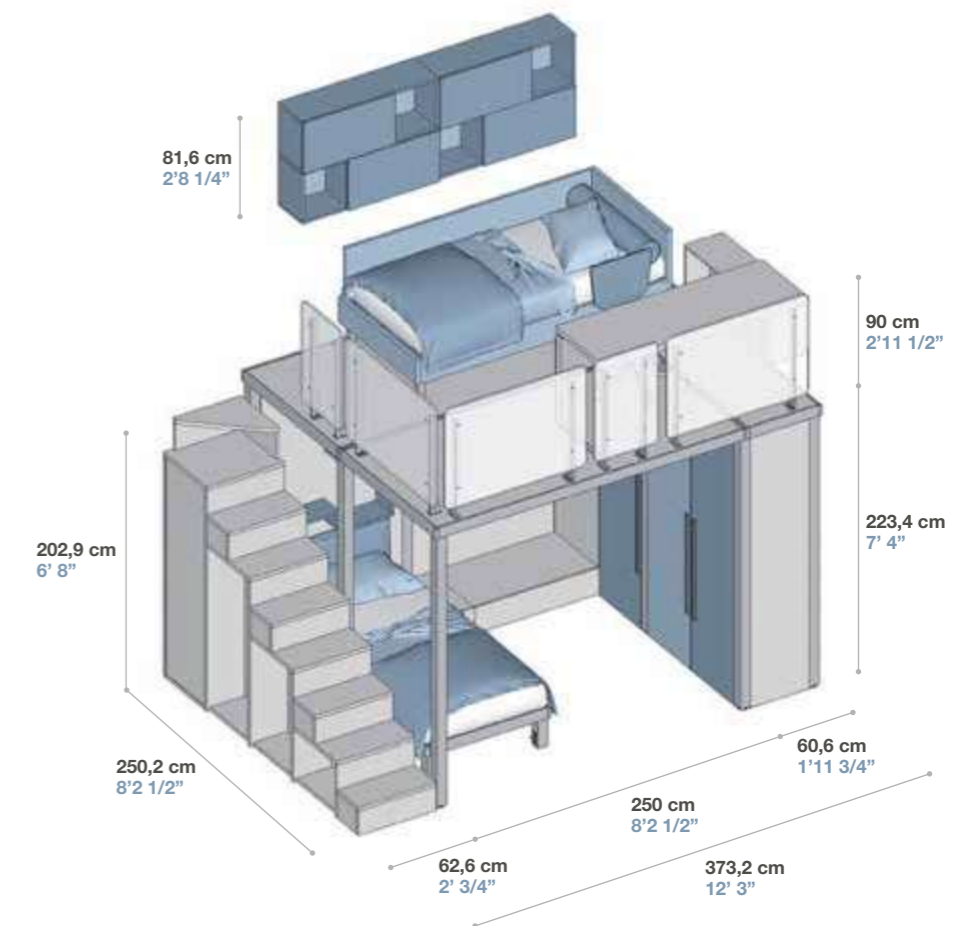

FINITURE / FINISHES

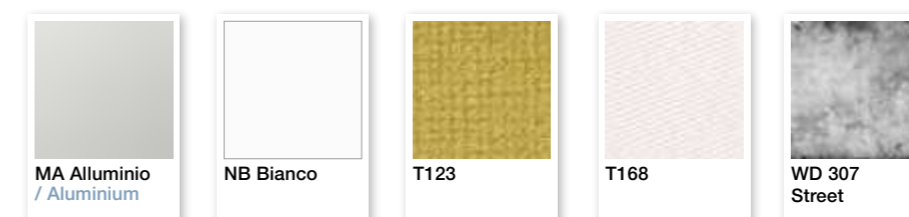





DESCRIZIONE TECNICA / TECHNICAL DATA

Q.TA Q.TY	CODICE CODE	A / H	L / W	P / D	DESCRIZIONE / DESCRIPTION
1	FF48	261,0	2,8	46,2	Fianco SYSTEM 28 / SYSTEM 28 Side
1	FT20	62,6	250,0	2,0	Pannello generico a mq sp. 20 / General panel per sqm th. 20
2	GH63	73,2	5,0	5,0	Tubo quadro 5x5 cm con piastra e piede per sostegno piani / Floor square tube 5x5 cm with plate and foot for tops support
2	GT11	195,4	8,0	8,0	Tubo quadro 8x8 cm centrale con piastra e livellatore / Central square tube 8x8 with plate and level adjuster
1	GU30	8,0	121,0	8,0	Traverso orizzontale / Horizontal beam
2	KK83	5,8	9,5	2,8	Passacavo rettangolare in pvc / Rectangular cable-router in pvc
1	LBX6	178,4	250,2	62,6	Scala con vani e ante con apertura push-pull / Stairs with open sections and doors with push-pull opening
1	LE92X	10,2	128,6	206,6	Letto EVO 1 piazza e mezzo senza testata / EVO 3/4 bed without upholstered headboard
3	LS03V	193,7	111,5	2,0	Pannello di chiusura verticale per soppalco / Vertical closing panel for mezzanine
2	LSA09	193,7	102,0	2,0	Pannello di chiusura laterale soppalco / Closing side panel for mezzanine
1	LW42X	75,0	99,5	211,0	Letto SYSTEM SCRIGNO singolo imbottito fisso con testata e schiena H.75 cm / SYSTEM SCRIGNO upholstered single fixed bed with headboard and back H.75 cm
2	MGLAN56	191,7	61,2	2,0	Maggiorazione laccatura anta / Supplement for door lacquering
1	MGLLB7H	178,4	250,2	62,6	Maggiorazione laccatura anta / Supplement for door lacquering
1	MGLLB7K	178,4	250,2	62,6	Maggiorazione laccatura anta / Supplement for door lacquering
1	MGLLB7L	178,4	250,2	62,6	Maggiorazione laccatura anta / Supplement for door lacquering
1	MGSP02	62,6	250,0	2,0	Maggiorazione per spinatura / Supplement for doweling
1	MGT2	193,7	102,0	2,0	Maggiorazione per oblo su pannello / Supplement for porthole on panel
1	MJB24	4,0	127,0	110,9	Piano sagomato / Shaped top
2	MQ94	63,0	110,0	33,4	Contenitore con piedi 8x8 cm con 3 vani e ribalta / Cabinet with 8x8 feet and 3 section with tilt door
1	PR3R	90,0	173,0	2,0	Protezione per scale in polycarbonato trasparente / Protection for stairs in transparent polycarbonate
1	PR3T	243,0	212,6	2,0	Protezione per scale in polycarbonato trasparente / Protection for stairs in transparent polycarbonate
1	PUF8	41,5	115,5	5,0	Formella imbottita sfoderabile / Upholstered and removable shape
2	Q507	261,0	61,6	46,2	Colonna libreria SYSTEM 28 da comp. 302 / Bookcase column SYSTEM 28 from comp. 302
1	Q508A	261,0	123,2	46,2	Colonna libreria SYSTEM 28 da comp. 302 / Bookcase column SYSTEM 28 from comp. 302
1	Q508B	93,2	120,4	35,4	Colonna libreria SYSTEM 28 da comp. 302-303 / Bookcase column SYSTEM 28 from comp. 302-303
1	S147A	198,4	250,0	125,0	Soppalco con piano trafile / Mezzanine with profiles
1	S147B	198,4	250,0	125,0	Soppalco con piano trafile / Mezzanine with profiles
1	SE72	90,5	65,0	65,0	Sedia con ruote e regolabile in altezza con scocca in legno e basamento in metallo / Chair on castors adjustable in height with wooden structure and metal base
1	SE79	90,5	65,0	65,0	Seduta imbottita sfoderabile per SE72 e SE76 / Upholstered and removable seat for SE72 and SE76
2	TBE4	6,6	4,5	41,0	Tubi appendiabiti alluminio / Closet rod in aluminium
1	TS88	1,2	251,0	47,2	Top di finitura / Finishing top
1	ZM40	175,4	0,0	0,0	Apertura push-pull / Push-pull opening

INGOMBRI / DIMENSIONS

CONFIGURATION
302

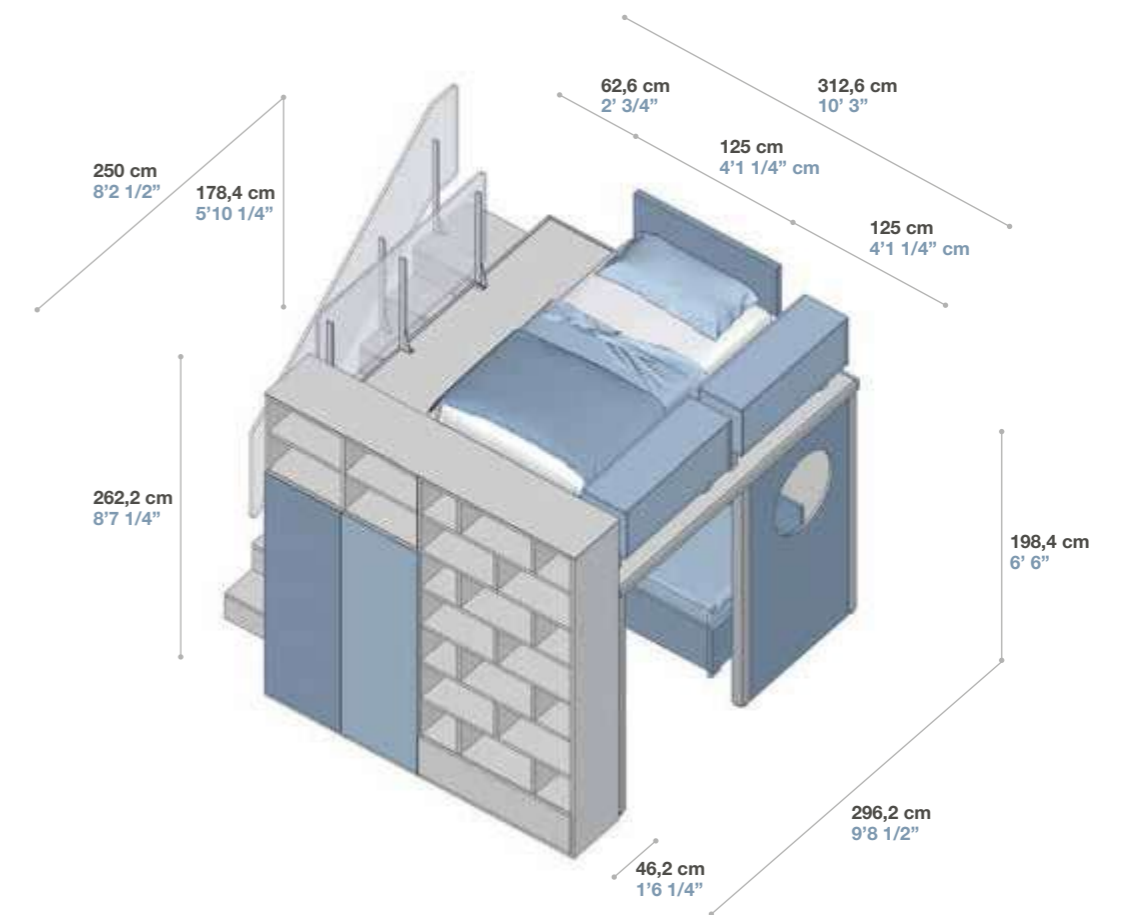

FINITURE / FINISHES

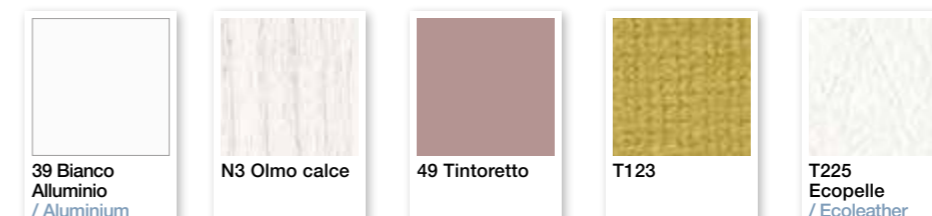

#GLAM TRAVELLER GUY

SOPPALCHI CON TRAFILA
Mezzanines with profiles



CONFIGURATION
303



DESCRIZIONE TECNICA / TECHNICAL DATA

Q.TA Q.TY	CODICE CODE	A / H	L / W	P / D	DESCRIZIONE / DESCRIPTION
1	CSL05	34,0	52,3	43,7	Comodino a terra con 2 cassetti / Floor night table with 2 drawers
1	CSL09	34,0	81,5	43,7	Comodino a terra con 1 cassettone / Floor night table with 1 high drawer
1	FF49	293,0	2,8	46,2	Fianco SYSTEM 28 / SYSTEM 28 side
1	FT20	34,8	111,5	2,0	Pannello generico a mq sp. 20 / General panel per sqm th. 20
1	FT20	94,6	151,6	2,0	Pannello generico a mq sp. 20 / General panel per sqm th. 20
1	FT20	94,6	159,0	2,0	Pannello generico a mq sp. 20 / General panel per sqm th. 20
2	GT11	195,4	8,0	8,0	Tubo quadro 8x8 cm centrale con piastra e livellatore / Central square tube 8x8 with plate and level adjuster
2	KK83	5,8	9,5	2,8	Passacavo rettangolare in pvc / Rectangular cable-router in pvc
6	LB7A	2,8	52,8	27,9	Ripiano per vano scala / Shelf for stair section
3	LB7C	2,8	50,0	57,8	Ripiano per vano scala / Shelf for stair section
1	LBX6V	178,4	250,2	62,6	Scala a composizione / Stair
1	LH96S	41,4	148	203,6	Letto CLIO matrimoniale con rete a doghe / Double bed CLIO with slats
1	LS03V	193,7	111,5	2,0	Pannello di chiusura verticale per soppalco / Vertical closing panel for mezzanine
2	LS03V	190,3	117,0	2,0	Pannello di chiusura verticale per soppalco / Vertical closing panel for mezzanine
1	LSA08	190,3	48,5	2,0	Pannello di chiusura laterale soppalco / Closing side panel for mezzanine
2	LSA09	193,7	102,0	2,0	Pannello di chiusura laterale soppalco / Closing side panel for mezzanine
1	LW44X	75,0	99,5	211,0	Letto SYSTEM SCRIGNO singolo imbottito fisso con testata pediera e schiena H.75 cm / SYSTEM SCRIGNO upholstered single fixed bed with headboard, footboard and back H.75 cm
1	MGSP02	34,8	111,5	2,0	Maggiorazione per spinatura / Supplement for doweling
1	MGSP02	94,6	151,6	2,0	Maggiorazione per spinatura / Supplement for doweling
1	MGSP02	94,6	159,0	2,0	Maggiorazione per spinatura / Supplement for doweling
1	MGT2	193,7	102,0	2,0	Maggiorazione per oblo su pannello / Supplement for porthole on panel
2	PR3Q	90,0	114,0	2,0	Protezione per scale in policarbonato trasparente / Protection for stairs in transparent polycarbonate
1	PR3R	90,0	173,0	2,0	Protezione per scale in policarbonato trasparente / Protection for stairs in transparent polycarbonate
1	PR3T	243,0	212,6	2,0	Protezione per scale in policarbonato trasparente / Protection for stairs in transparent polycarbonate
3	PX26LL	4,0	20,0	0,2	Maniglia ad incasso rettangolare con fondo e bordo laccato / Recessed rectangular handle with lacquered back and edge
3	Q490	293,0	61,6	46,2	Colonna libreria SYSTEM 28 da comp. 303 / Bookcase column SYSTEM 28 from comp. 303
1	Q491	293,0	123,2	46,2	Colonna libreria SYSTEM 28 da comp. 303 / Bookcase column SYSTEM 28 from comp. 303
1	Q508B	93,2	120,4	35,4	Colonna libreria SYSTEM 28 da comp. 302-303 / Bookcase column SYSTEM 28 from comp. 302-303
1	S303A	198,4	250,0	125,0	Sistema trafilato per soppalco / Profiles system for mezzanine
1	S303B	198,4	250,0	125,0	Sistema trafilato per soppalco / Profiles system for mezzanine
1	S303C	198,4	250,0	62,0	Sistema trafilato per soppalco / Profiles system for mezzanine
1	SE10	97,0	65,0	65,0	Sedia con ruote e regolabile in altezza con scocca imbottita sfoderabile e basamento in metallo / Chair on castors adjustable in height with upholstered and removable structure and metal base
2	TBE4	6,6	4,5	41,0	Tubi appendiabiti alluminio / Closet rod in aluminium
1	TFA01	76,2	229,0	59,0	Scrivania indipendente con piano trafilato / Self-standing desk with profiles
1	TS89	1,2	151,6	51,9	Top di finitura / Finishing top
1	TS89	1,2	159,0	51,9	Top di finitura / Finishing top
1	UV99	100,0	352,0	0,1	Stampa digitale su pannello con immagine archivio Tumidei o cliente / Digital print on panel with image from Tumidei' library or from customer

INGOMBRI / DIMENSIONS

CONFIGURATION
303

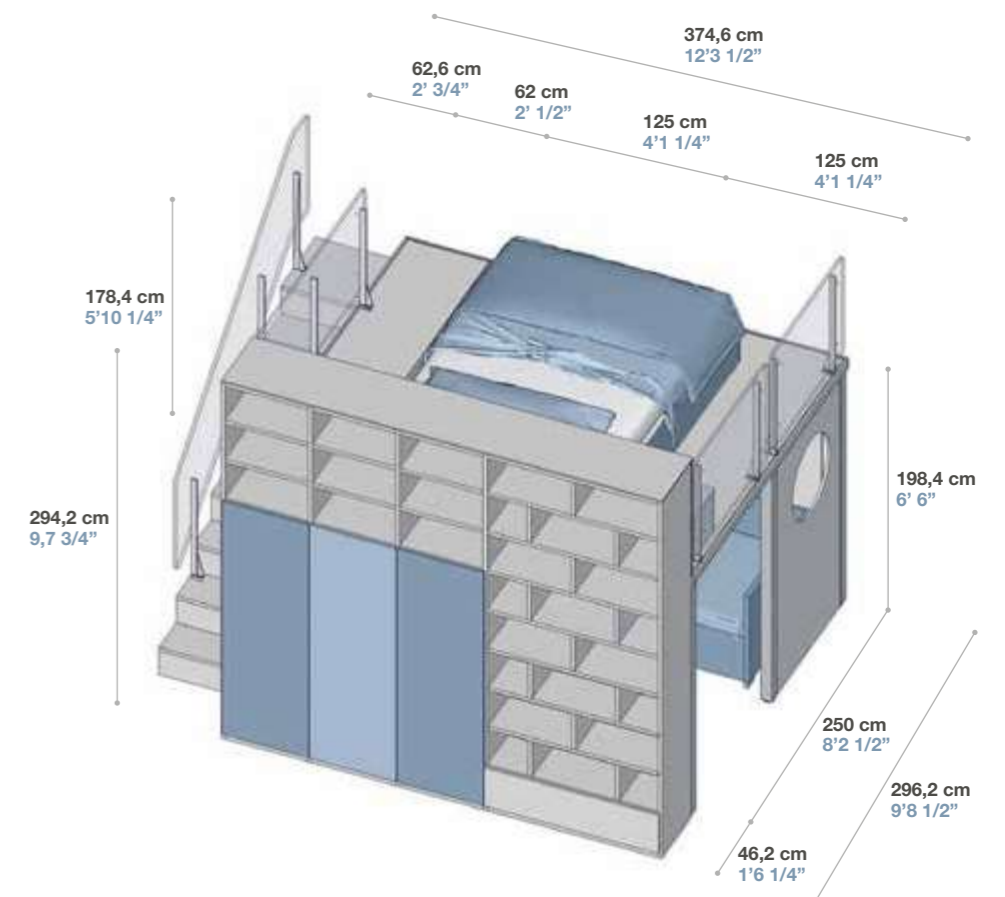

FINITURE / FINISHES

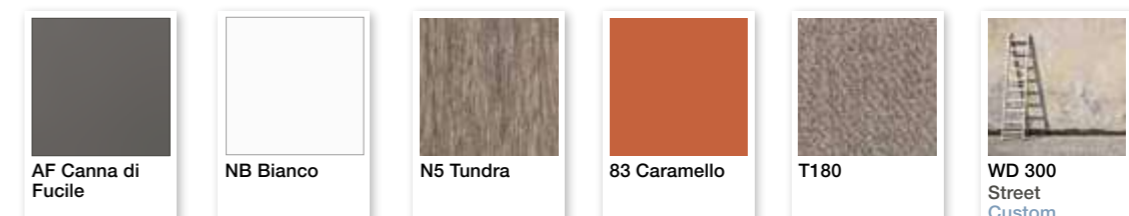

CONFIGURATION
304



Configuration 304



Tavolo abbattibile.
Fall-front table.



DESCRIZIONE TECNICA / TECHNICAL DATA

Q.TA Q.TY	CODICE CODE	A / H	L / W	P / D	DESCRIZIONE / DESCRIPTION
2	B211	101,0	85,6	56,8	Colonna armadio 2 ante / Column wardrobe 2 doors
1	B212	101,0	85,6	56,8	Colonna armadio 6 cassetti / Column wardrobe with 6 drawers
2	FN43	101,0	3,2	59,0	Fianco finale SYSTEM 32 / End side SYSTEM 32
1	FN43	101,0	3,2	59,0	Fianco finale SYSTEM 32 / End side SYSTEM 32
1	FN53	101,0	2,5	56,8	Divisore intermedio / Intermediate Partition
1	FNA43	101,0	3,2	75,5	Fianco SYSTEM 32 / SYSTEM 32 side
1	GT6PL	106,2	8,0	8,0	Tubo quadro 8x8 cm angolare o centrale con livellatore / Angular or central square tube 8x8 with level adjuster
1	GT86L	106,2	8,0	8,0	Tubo quadro 8x8 cm con livellatore per piani accoppiati / Square tube 8x8 cm with level adjuster for joint tops
1	LE92X	10,2	128,6	206,6	Letto EVO 1 piazza e mezzo senza testata / EVO 3/4 bed without upholstered headboard
2	LSA43	100,1	55,6	2,0	Ante a soffietto per chiusura vano sotto soppalco / Accordion doors to close under mezzanine area
1	ME32	2,8	35,6	33,4	Mensola lineare con reggimensola a scomparsa / Linear shelf with concealed bracket
2	MK36	2,8	75,4	27,4	Mensola lineare sagomata da comp. 304 / Linear shelf with shape from comp. 304
2	MQ73	18,0	52,3	41,5	Comodino pensile con 1 cassetto / Hanging night table with 1 drawer
2	PR32	75,0	100,0	2,0	Protezione in metallo per soppalco / Metal protection for mezzanine
2	PR35	50,0	100,0	2,0	Rivestimento in tessuto con tasche per protezione PR31 e PR32 / Covering in fabric with pockets for protections PR31 and PR32
1	PUF8	41,5	115,0	5,0	Formella imbottita sfoderabile / Upholstered and removable shape
6	PX73	5,5	5,5	0,4	Maniglia ad incasso quadrata con presa in rilievo / Squared recessed handles with grip
6	PX74	11,0	11,0	0,6	Maniglia ad incasso quadrata con presa in rilievo / Squared recessed handles with grip
1	S304A	109,2	266,6	125,0	Sistema trafia per soppalco / Profiles system for mezzanine
1	S304B	109,2	266,6	125,0	Sistema trafia per soppalco / Profiles system for mezzanine
1	SC74	170,0	98,4	64,5	Scala a ventaglio per soppalco H.109.2 cm / Fan-shaped stair for mezzanine H.109.2 cm
1	SE72	90,5	65,0	65,0	Sedia con ruote e regolabile in altezza con scocca in legno e basamento in metallo / Chair on castors adjustable in height with wooden structure and metal base
1	SE79	90,5	65,0	65,0	Seduta imbottita sfoderabile per SE72 e SE76 / Upholstered and removable seat for SE72 and SE76
1	TQ92	2,8	166,6	59,0	Scrivania pensile spessore 2.8 cm abbattibile a parete / Wall fall-front desk thickness 2.8 cm
2	VS25	20,0	56,5	20,5	Mensola T-BOX L 56.5 cm / T-BOX shelf W 56.5 cm
1	VS26	20,0	100,0	20,5	Mensola T-BOX L 100 cm / T-BOX shelf W 100 cm

INGOMBRI / DIMENSIONS

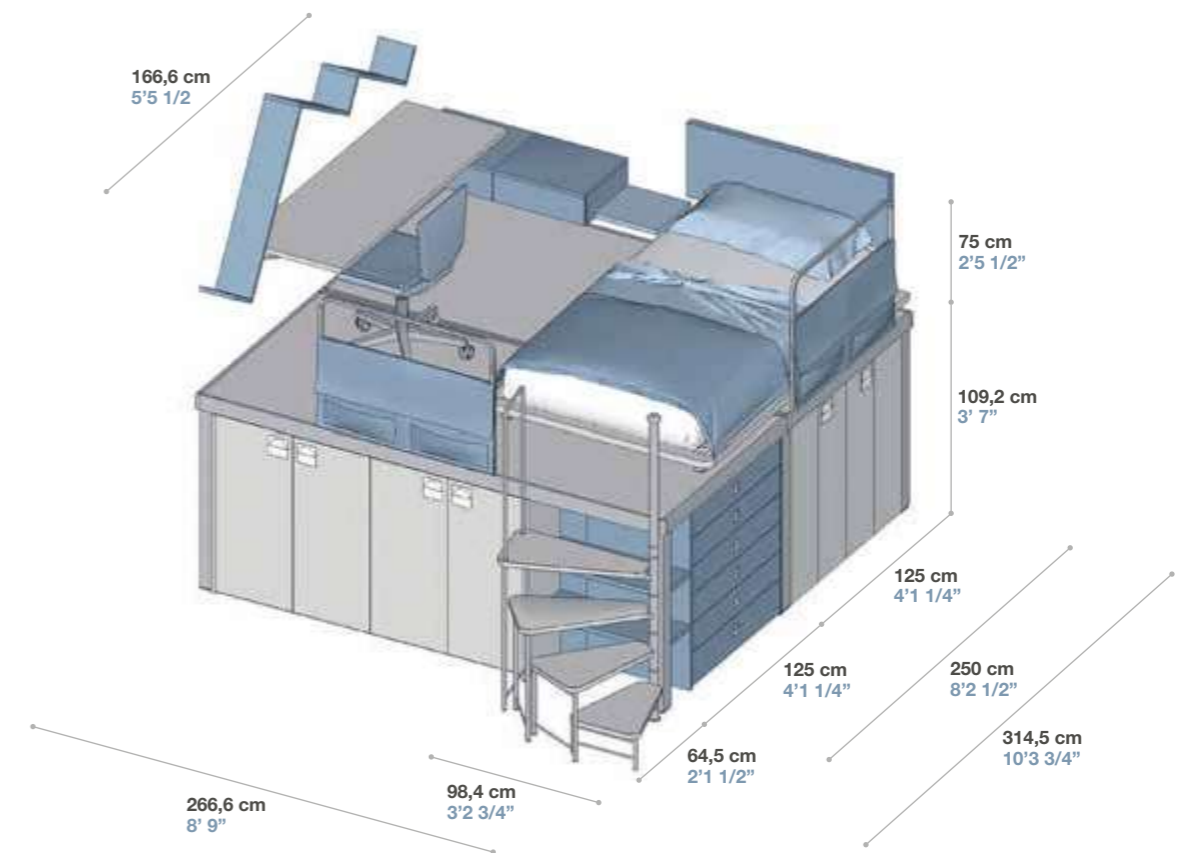
CONFIGURATION
304

FINITURE / FINISHES

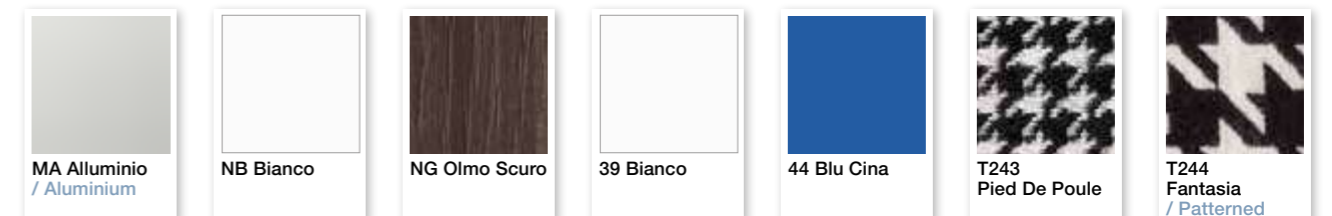

#PRETTY DANCER

SOPPALCHI CON TRAFILA
Mezzanines with profiles



Configuration 305

CONFIGURATION
305





DESCRIZIONE TECNICA / TECHNICAL DATA

Q.TA Q.TY	CODICE CODE	A / H	L / W	P / D	DESCRIZIONE / DESCRIPTION
1	B100	197,0	41,6	56,8	Colonna armadio 1 anta / Column wardrobe 1 door
1	B146	261,0	85,6	56,8	Colonna armadio 2 ante / Column wardrobe 2 doors
1	FN46	197,0	3,2	59,0	Fianco SYSTEM 32 / SYSTEM 32 Side
1	FN48	261,0	3,2	59,0	Fianco SYSTEM 32 / SYSTEM 32 Side
1	FN76	197,0	1,2	56,8	Fianco spessore 1,2 cm / Side thickness 1,2 cm
1	FN78	261,0	1,2	56,8	Fianco spessore 1,2 cm / Side thickness 1,2 cm
1	GR23	73,2	4,0	59,0	Gamba telaio in metallo / Frame leg in metal
1	KR82	32,5	100,0	5,0	CITY SCAPE "LONDON" / CITY SCAPE "LONDON"
1	LR35	53,2	96,6	203,5	Letto BIG singolo inferiore su ruote con rete a doghe e coppia cassetti / BIG single lower bed on castors with slatted base and couple of drawers
1	LS03V	136,5	115,5	2,0	Pannello di chiusura verticale per soppalco / Vertical closing panel for mezzanine
1	LS46	59,5	106,0	2,0	Pannello di chiusura laterale soppalco / Closing side panel for mezzanine
1	LSA03	136,5	106,0	2,0	Pannello di chiusura laterale soppalco / Closing side panel for mezzanine
1	LSA44	132,1	81,0	2,0	Ante a soffietto per chiusura vano sotto soppalco / Accordion doors to close under mezzanine area
1	MGS2	4,0	130,0	59,0	Maggiorazione 1 raggiatura 5 cm / Supplement for 1 radius 5 cm
1	MGT3	136,5	115,5	2,0	Maggiorazione per livellatore e predisposizione per fissaggio a trafilata / Supplement for level adjuster and set up for profiles fixing
1	MP31	24,5	50,0	54,5	Scala angolare con 1 gradino / Corner stair with 1 step
1	MP96	22,0	50,0	56,5	Pedana con cassetto / Base with drawer
1	MY04	4,0	130,0	59,0	Piano sagomato o lineare senza supporti laterali / Shaped or linear top
1	PR31	50,0	100,0	2,0	Protezione in metallo per soppalco / Metal protection for mezzanine
1	PR32	75,0	100,0	2,0	Protezione in metallo per soppalco / Metal protection for mezzanine
2	PR35	50,0	100,0	2,0	Rivestimento in tessuto con tasche per protezione PR31 e PR32 / Covering in fabric with pockets for protections PR31 and PR32
5	PX78	10,0	18,0	3,2	Maniglia rettangolare / Rectangular handle
1	S163	141,2	216,0	125,0	Soppalco singolo / Single mezzanine
1	S164	64,2	226,0	125,0	Soppalco singolo / Single mezzanine
1	SC72	66,0	66,0	55,2	Scala a ventaglio per soppalco H.66.2 cm / Fan-shaped stair for mezzanine H.66.2 cm
1	SE72	90,5	65,0	65,0	Sedia con ruote e regolabile in altezza con scocca in legno e basamento in metallo / Chair on castors adjustable in height with wooden structure and metal base
1	SE79	90,5	65,0	65,0	Seduta imbottita sfoderabile per SE72 e SE76 / Upholstered and removable seat for SE72 and SE76
1	TBK33	6,5	200,0	2,0	Tubo appendiabiti in alluminio / Linear hanging rail in aluminium
1	TE09	50,0	123,0	10,0	Testata imbottita sfoderabile / Upholstered and removable headboard
1	UV99	100,0	146,8	0,1	Stampa digitale su pannello con immagine archivio Tumidei o cliente / Digital print on panel with image from Tumidei library or from customer
1	VS24	20,0	43,5	20,5	Mensola T-BOX L 43.5 cm / T-BOX shelf W 43.5 cm
2	VS25	20,0	56,5	20,5	Mensola T-BOX L 56.5 cm / T-BOX shelf W 56.5 cm
1	VS26	20,0	100,0	20,5	Mensola T-BOX L 100 cm / T-BOX shelf W 100 cm

INGOMBRI / DIMENSIONS

CONFIGURATION
305

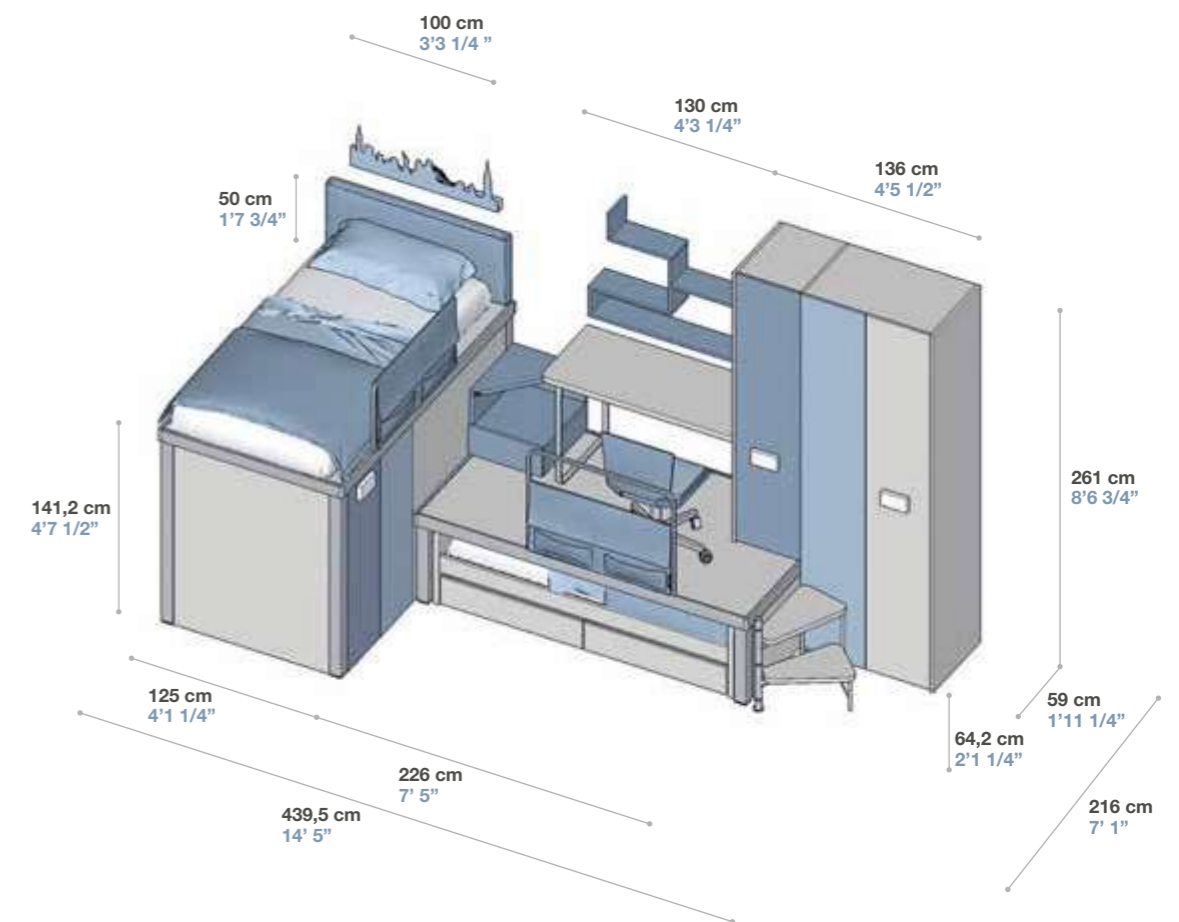

FINITURE / FINISHES

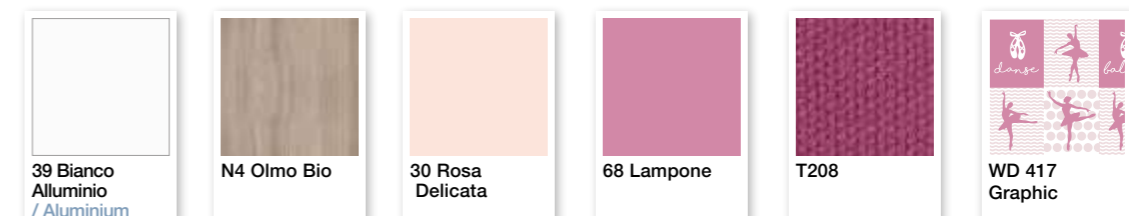

CONFIGURATION
306





DESCRIZIONE TECNICA / TECHNICAL DATA

Q.TA Q.TY	CODICE CODE	A / H	L / W	P / D	DESCRIZIONE / DESCRIPTION
1	B100	197,0	41,6	56,8	Colonna armadio 1 anta / Column wardrobe 1 door
1	B146	261,0	85,6	56,8	Colonna armadio 2 ante / Column wardrobe 2 doors
1	FN46	197,0	3,2	59,0	Fianco SYSTEM 32 / SYSTEM 32 Side
1	FN48	261,0	3,2	59,0	Fianco SYSTEM 32 / SYSTEM 32 Side
1	FN76	197,0	1,2	56,8	Fianco spessore 1,2 cm / Side thickness 1,2 cm
1	FN78	261,0	1,2	56,8	Fianco spessore 1,2 cm / Side thickness 1,2 cm
1	KR83	35,5	100,0	5,0	CITY SCAPE "NEW YORK" / CITY SCAPE "NEW YORK"
1	LR35	53,2	96,6	203,5	Letto BIG singolo inferiore su ruote con rete a doghe e coppia cassetti / BIG single lower bed on castors with slatted base and couple of drawers
1	LS46	59,5	106,0	2,0	Pannello di chiusura laterale soppalco / Closing side panel for mezzanine
2	LSA03	136,5	106,0	2,0	Pannello di chiusura laterale soppalco / Closing side panel for mezzanine
1	LSA44	132,1	81,0	2,0	Ante a soffietto per chiusura vano sotto soppalco / Accordion doors to close under mezzanine area
1	MGT3	136,5	106,0	2,0	Maggiorazione per livellatore e predisposizione per fissaggio a trafila / Supplement for level adjuster and set up for profiles fixing
3	ML84	24,0	50,0	25,0	Mensola in metallo con fianchi e schiena in legno spessore 2 cm / Metal shelf with sides and wooden back thickness 2 cm
3	PM66	0,8	20,0	4,0	Maniglia Side H. 200 / Side handle H. 200
1	PR31	50,0	100,0	2,0	Protezione in metallo per soppalco / Metal protection for mezzanine
2	PR32	75,0	100,0	2,0	Protezione in metallo per soppalco / Metal protection for mezzanine
3	PR35	50,0	100,0	2,0	Rivestimento in tessuto con tasche per protezione PR31 e PR32 / Covering in fabric with pockets for protections PR31 and PR32
1	S163	141,2	216,0	125,0	Soppalco singolo / Single mezzanine
1	S164	64,2	226,0	125,0	Soppalco singolo / Single mezzanine
1	SC70	190,2	109,4	68,8	Scala a ventaglio per soppalco H.141.2 cm / Fan-shaped stair for mezzanine H.141.2 cm
1	SC72	66,0	66,0	55,2	Scala a ventaglio per soppalco H.66.2 cm / Fan-shaped stair for mezzanine H.66.2 cm
1	SE72	90,5	65,0	65,0	Sedia con ruote e regolabile in altezza con scocca in legno e basamento in metallo / Chair on castors adjustable in height with wooden structure and metal base
1	SE79	90,5	65,0	65,0	Seduta imbottita sfoderabile per SE72 e SE76 / Upholstered and removable seat for SE72 and SE76
1	TBK33	6,5	200,0	2,0	Tubo appendiabiti in alluminio / Linear hanging rail in aluminium
1	TE09	50,0	123,0	10,0	Testata imbottita sfoderabile / Upholstered and removable headboard
1	TQ83	24,0	178,5	59,0	Scrittoio pensile spessore 4 cm con fascia H.20 cm / Wall desk thickness 4 cm with strip H.20 cm
1	UV99	100,0	314,4	0,1	Stampa digitale su pannello con immagine archivio Tumidei o cliente / Digital print on panel with image from Tumidei' library or from customer
1	ZM40	195,1	0,0	0,0	Apertura push-pull / Push-pull opening
2	ZM40	259,1	0,0	0,0	Apertura push-pull / Push-pull opening

INGOMBRI / DIMENSIONS

CONFIGURATION
306

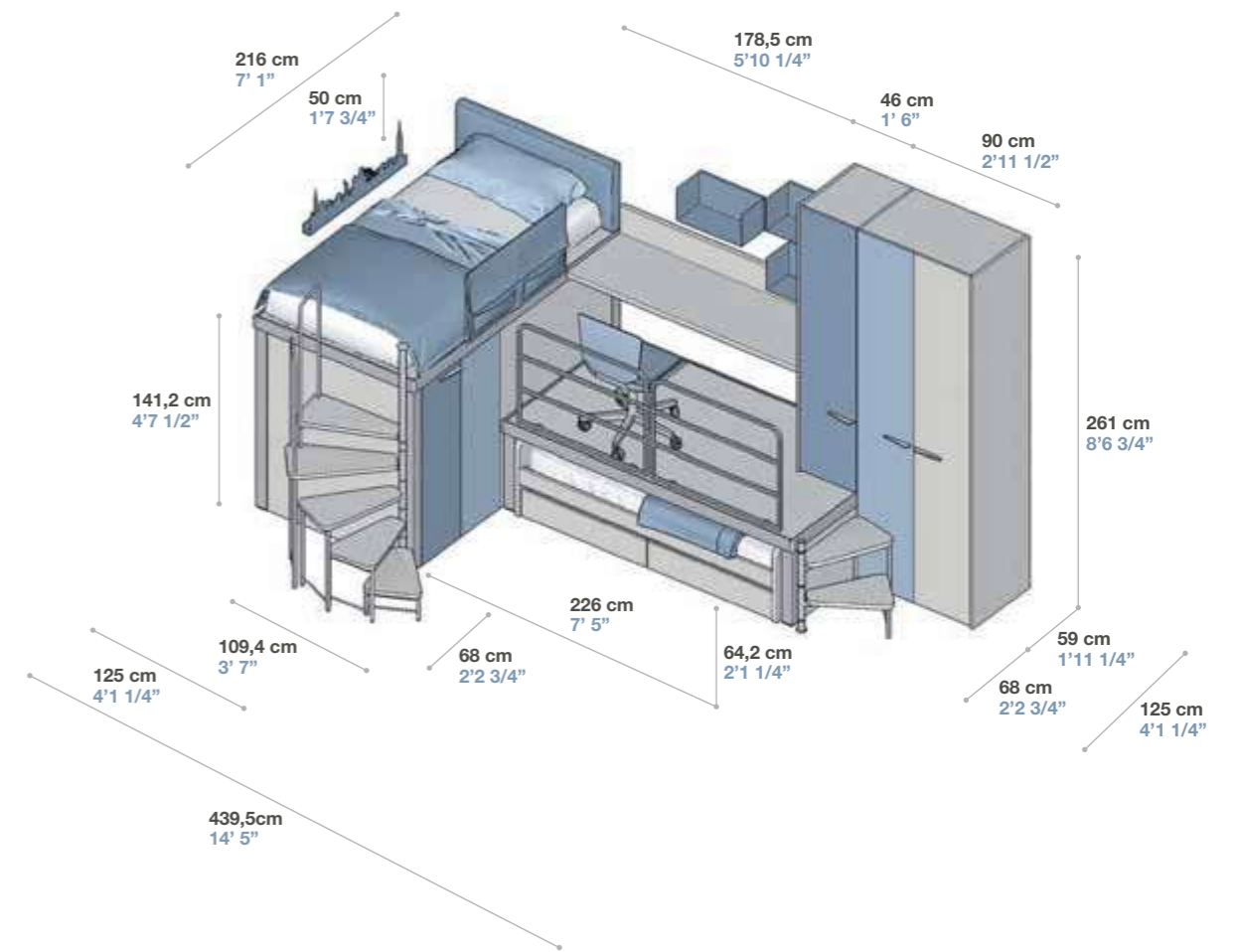

FINITURE / FINISHES



CONFIGURATION
307



DESCRIZIONE TECNICA / TECHNICAL DATA

Q.TA Q.TY	CODICE CODE	A / H	L / W	P / D	DESCRIZIONE / DESCRIPTION
1	B100	197,0	41,6	56,8	Colonna armadio 1 anta / Column wardrobe 1 door
2	B213	53,0	56,4	56,8	Colonna 3 cassetti da comp. 307 / 3-drawers column from comp. 307
2	EZ42	72,2	3,0	31,6	Supporto metallico per 2 mensole / Metal support for 2 shelves
2	FN42	53,0	3,2	59,0	Fianco finale SYSTEM 32 / End side SYSTEM 32
2	FN46	197,0	3,2	59,0	Fianco SYSTEM 32 / SYSTEM 32 Side
1	FN52	53,0	2,5	56,8	Divisore intermedio / Intermediate partition
2	KBR12	2,8	106,0	46,2	Mensola lineare / Linear shelf
1	KR83	35,5	100,0	5,0	CITY SCAPE "NEW YORK" / CITY SCAPE "NEW YORK"
1	LS46	59,5	106,0	2,0	Pannello di chiusura laterale soppalco / Closing side panel for mezzanine
1	LS56	59,5	54,2	2,0	Pannello di chiusura laterale soppalco / Closing side panel for mezzanine
2	LSA03	136,5	90,5	2,0	Pannello di chiusura laterale soppalco / Closing side panel for mezzanine
1	LSA54	132,1	106,0	2,0	Ante a soffietto per chiusura vano sotto soppalco / Accordion doors to close under mezzanine area
1	PR31	50,0	100,0	2,0	Protezione in metallo per soppalco / Metal protection for mezzanine
1	PR32	75,0	100,0	2,0	Protezione in metallo per soppalco / Metal protection for mezzanine
1	PUF8	41,5	115,0	5,0	Formella imbottita sfoderabile / Upholstered and removable shape
7	PX77	5,0	5,0	3,2	Maniglia quadrata / Square handle
1	PX78	10,0	18,0	3,2	Maniglia rettangolare / Rectangular handle
1	S160	141,2	200,0	125,0	Soppalco singolo / Single mezzanine
1	S161	61,0	195,0	125,0	Soppalco singolo / Single mezzanine
1	SC70	190,2	109,4	68,8	Scala a ventaglio per soppalco H.141.2 cm / Fan-shaped stair for mezzanine H.141.2 cm
1	SC72	66,0	66,0	55,2	Scala a ventaglio per soppalco H.66.2 cm / Fan-shaped stair for mezzanine H.66.2 cm
1	SE10	97,0	65,0	65,0	Sedia con ruote e regolabile in altezza con scocca imbottita sfoderabile e basamento in metallo / Chair on castors adjustable in height with upholstered and removable structure and metal base
1	TBK66	6,5	140,0	2,0	Tubo appendiabiti in alluminio / Linear hanging rail in aluminium
1	TQ83	24,0	144,5	59,0	Scrivania pensile spessore 4 cm con fascia H.20 cm / Wall desk thickness 4 cm with strip H.20 cm
1	UV99	100,0	225,0	0,1	Stampa digitale su pannello con immagine archivio Tumidei o cliente / Digital print on panel with image from Tumidei' library or from customer
1	VS24	20,0	43,5	20,5	Mensola T-BOX L 43.5 cm / T-BOX shelf W 43.5 cm
1	VS26	20,0	100,0	20,5	Mensola T-BOX L 100 cm / T-BOX shelf W 100 cm

INGOMBRI / DIMENSIONS

CONFIGURATION
307

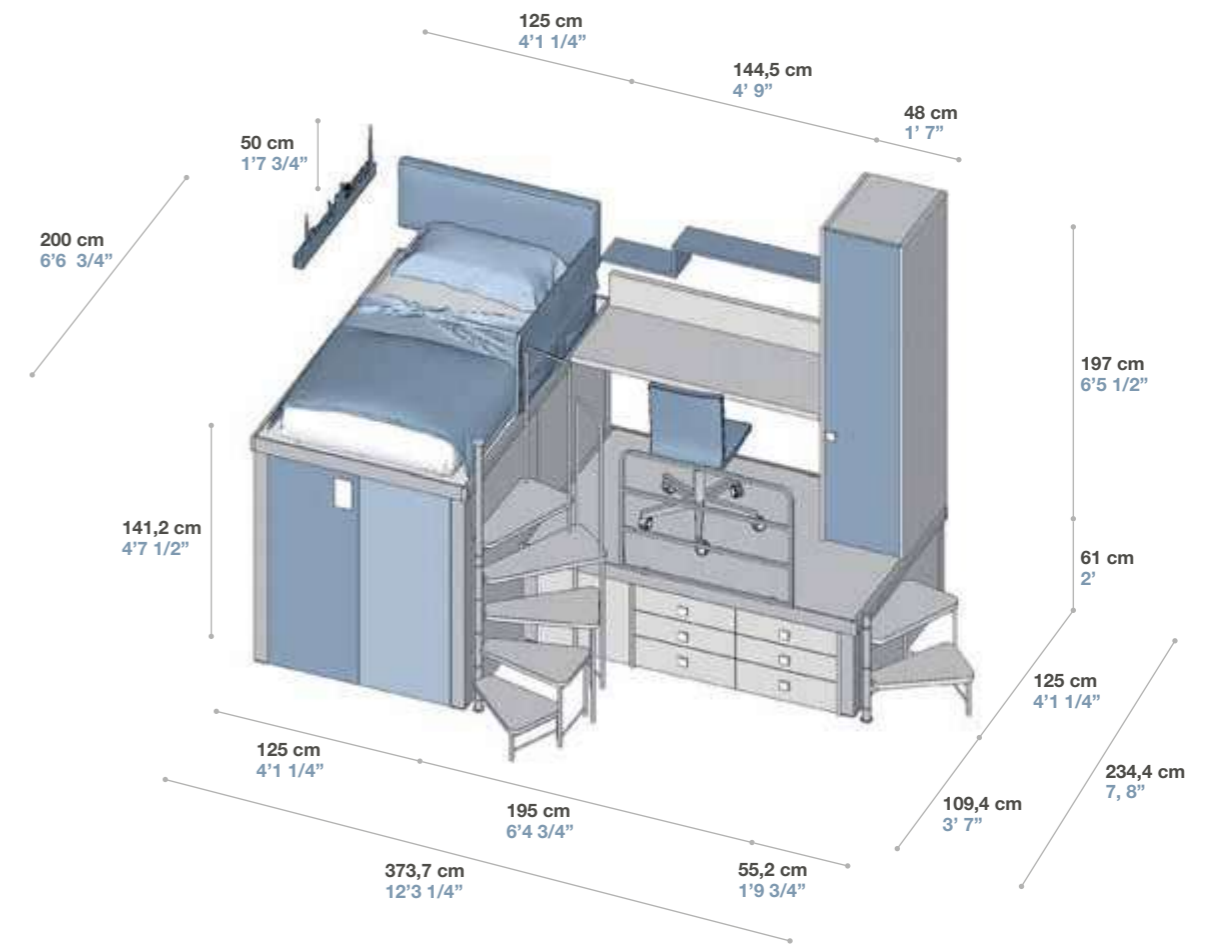

FINITURE / FINISHES

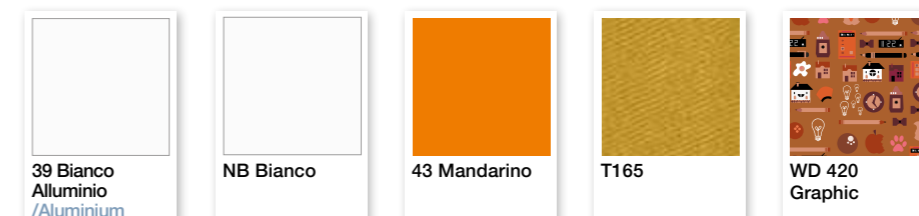



#NORDIC GUYS

SOPPALCHI CON TRAFILA
Mezzanines with profiles

R

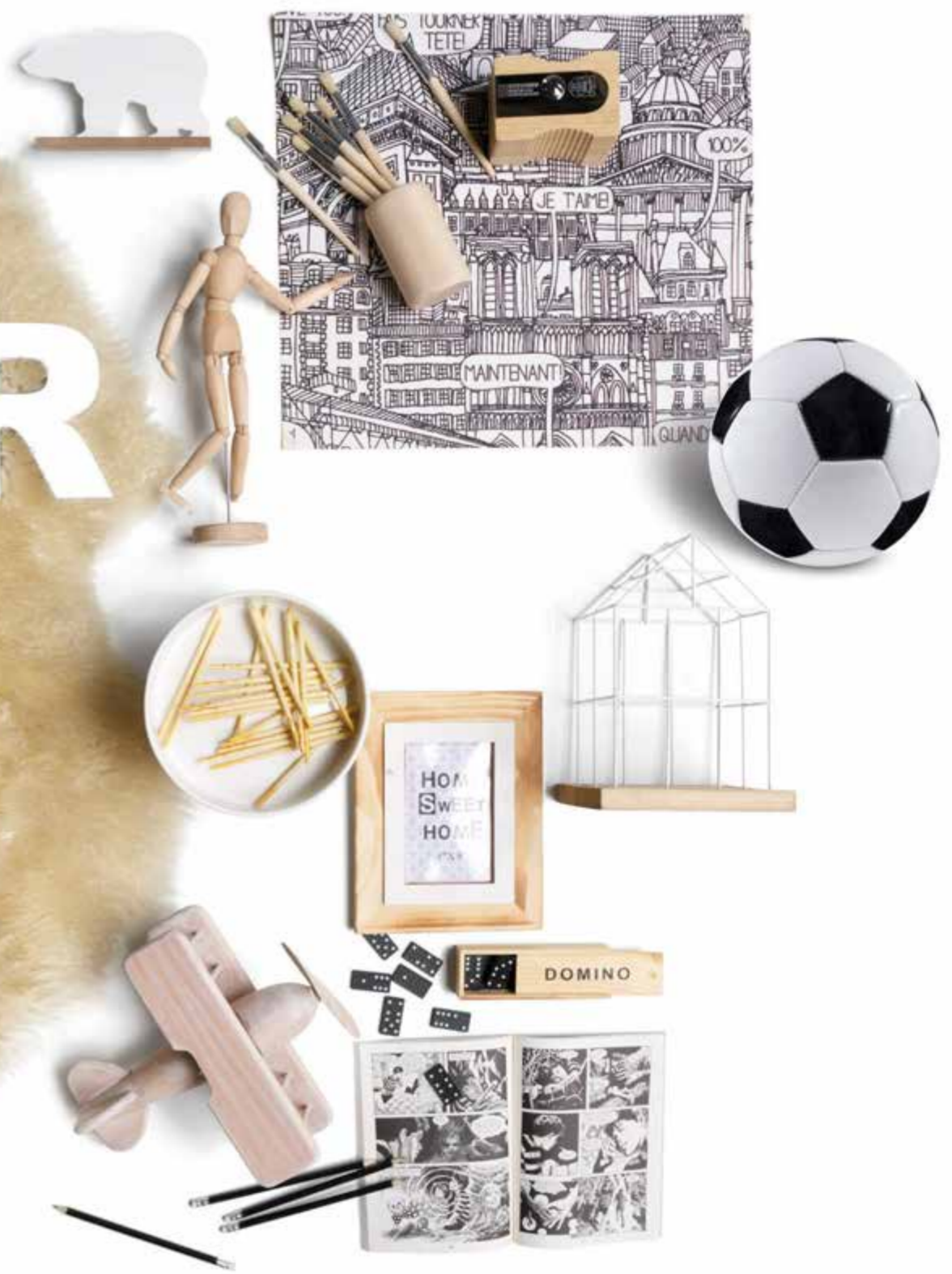





DESCRIZIONE TECNICA / TECHNICAL DATA

Q.TA Q.TY	CODICE CODE	A / H	L / W	P / D	DESCRIZIONE / DESCRIPTION
1	B225	133,0	56,4	56,8	Colonna armadio 1 anta e 4 cassetti / Column wardrobe with 1 door and 4 drawers
2	FN44	133,0	3,2	59,0	Fianco finale SYSTEM 32 / End side SYSTEM 32
1	LH36X	41,4	98,0	208,6	Letto SYSTEM SCRIGNO singolo fisso / SYSTEM SCRIGNO single fixed bed
1	LS48	104,5	86,0	2,0	Pannello di chiusura laterale soppalco / Closing side panel for mezzanine
1	LS60	136,5	81,0	2,0	Pannello di chiusura laterale soppalco / Closing side panel for mezzanine
1	LS60	136,5	78,2	2,0	Pannello di chiusura laterale soppalco / Closing side panel for mezzanine
1	LSA01	27,5	81,0	2,0	Pannello di chiusura laterale soppalco / Closing side panel for mezzanine
1	LSA34	132,1	52,7	2,0	Anta singola per chiusura vano sotto soppalco / Single door to close under mezzanine area
1	MGT1	132,1	52,7	2,0	Maggiorazione per scasso su pannello di chiusura o anta / Supplements for carving on closing panel or door
1	MGT3	136,5	78,2	2,0	Maggiorazione per livellatore e predisposizione per fissaggio a trafila / Supplement for level adjuster and set up for profiles fixing
4	PM65	0,8	11,0	4,0	Maniglia Side H. 110 / Side handle H. 110
2	PM66	0,8	20,0	4,0	Maniglia Side H. 200 / Side handle H. 200
1	PR31	50,0	60,0	2,0	Protezione in metallo per soppalco / Metal protection for mezzanine
1	S162A	141,2	213,0	100,0	Soppalco con piano trafila a composizione / Profiles system for mezzanine
1	S162B	109,2	105,0	100,0	Soppalco con piano trafila a composizione / Profiles system for mezzanine
1	SC70	190,2	109,4	68,8	Scala a ventaglio per soppalco H.141.2 cm / Fan-shaped stair for mezzanine H.141.2 cm
1	TBK32	6,5	125,0	2,0	Tubo appendiabiti in alluminio / Linear hanging rail in aluminium
1	TE08	50,0	98,0	10,0	Testata imbottita sfoderabile / Upholstered and removable headboard
1	UV99	100,0	172,1	0,1	Stampa digitale su pannello con immagine archivio Tumidei o cliente / Digital print on panel with image from Tumidei' library or from customer
2	VS25	20,0	56,5	20,5	Mensola T-BOX L 56.5 cm / T-BOX shelf W 56.5 cm
1	VS26	20,0	100,0	20,5	Mensola T-BOX L 100 cm / T-BOX shelf W 100 cm

INGOMBRI / DIMENSIONS

CONFIGURATION
308

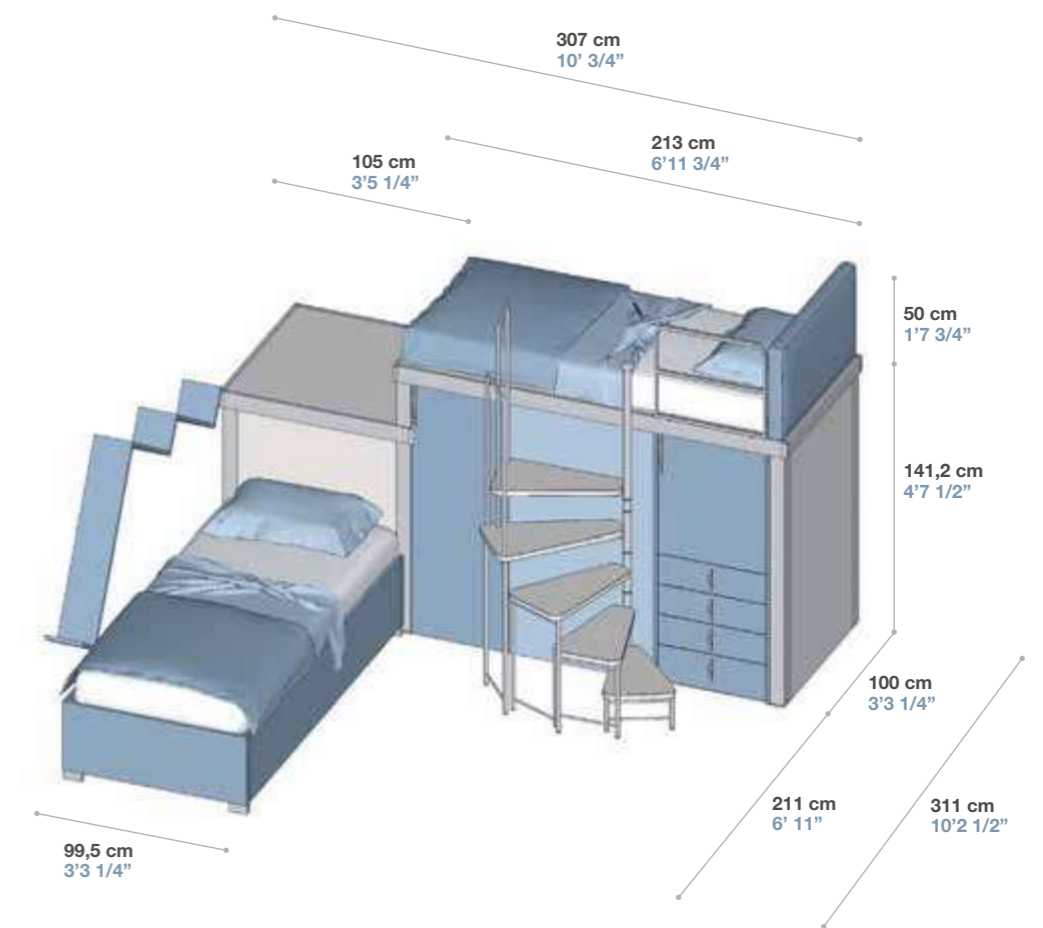

FINITURE / FINISHES

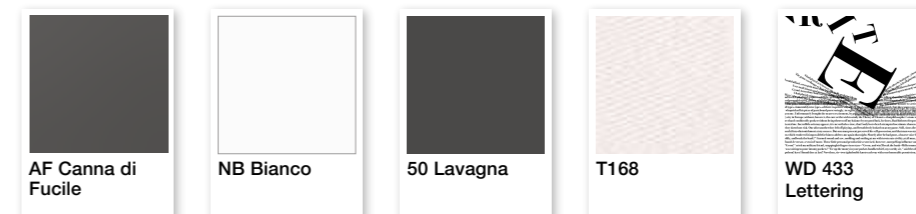

#GRUNGE ARTIST GIRL

SOPPALCHI CON TRAFILA
Mezzanines with profiles



Configuration 309

CONFIGURATION
309





Configuration 309



DESCRIZIONE TECNICA / TECHNICAL DATA

Q.TA Q.TY	CODICE CODE	A / H	L / W	P / D	DESCRIZIONE / DESCRIPTION
1	CSL13	50,0	37,5	43,7	Comodino a terra con 3 cassetti / Floor night table with 3 drawers
1	E185	161,6	160,0	80,0	Libreria a 2 mensole e piano scrittoio per composizione 309A / Bookcase with 2 shelves and desk for composition 309A
2	EZ41	38,4	3,0	31,6	Supporto metallico per 1 mensola / Metal support for 1 shelf
1	FT01	64,2	7,0	2,0	Fascia di tamponamento / Adjustment strip
1	FT01	11,5	37,5	2,0	Fascia di tamponamento / Adjustment strip
1	GT60L	63,2	8,0	8,0	Tubo quadro 8x8 cm angolare o centrale con livellatore / Angular or central square tube 8x8 with level adjuster
1	GT9ML	70,8	8,0	8,0	Tubo quadro 8x8 cm intermedio per piani non complanari al metro lineare / Square tube 8x8 cm for non-coplanar tops per linear meter
1	GT9ML	70,9	8,0	8,0	Tubo quadro 8x8 cm intermedio per piani non complanari al metro lineare / Square tube 8x8 cm for non-coplanar tops per linear meter
1	KBR11	2,8	81,0	46,2	Mensola lineare / Linear shelf
1	LR35	53,2	96,6	203,5	Letto BIG singolo inferiore su ruote con rete a doghe e coppia cassetti / BIG single lower bed on castors with slatted base and couple of drawers
2	LS46	61,5	90,0	2,0	Pannello di chiusura laterale soppalco / Closing side panel for mezzanine
1	LS60	136,5	26,1	2,0	Pannello di chiusura laterale soppalco / Closing side panel for mezzanine
1	LS60	136,5	65,5	2,0	Pannello di chiusura laterale soppalco / Closing side panel for mezzanine
1	LS60	136,5	65,5	2,0	Pannello di chiusura laterale soppalco / Closing side panel for mezzanine
1	LS60	136,5	81,0	2,0	Pannello di chiusura laterale soppalco / Closing side panel for mezzanine
1	LS63	71,4	54,8	2,0	Pannello di chiusura laterale soppalco / Closing side panel for mezzanine
1	LS63	71,5	55,0	2,0	Pannello di chiusura laterale soppalco / Closing side panel for mezzanine
1	LS63	71,5	81,0	2,0	Pannello di chiusura laterale soppalco / Closing side panel for mezzanine
1	LSA33	58,0	44,2	2,0	Anta singola per chiusura vano sotto soppalco / Single door to close under mezzanine area
1	LSA54	132,0	106,0	2,0	Ante a soffietto per chiusura vano sotto soppalco / Accordion doors to close under mezzanine area
2	MG75	33,3	71,6	2,0	Anta scorrevole con guida / Sliding door with rail
1	MGT1	136,5	26,1	2,0	Maggiorazione per scasso su pannello di chiusura o anta / Supplements for carving on closing panel or door
1	MGT1	136,5	65,5	2,0	Maggiorazione per scasso su pannello di chiusura o anta / Supplements for carving on closing panel or door
1	MGT4	136,5	65,5	2,0	Maggiorazione per livellatori e predisposizione per unione pannelli / Supplement for level adjuster and set up for panels joining
1	MGT4	136,5	65,5	2,0	Maggiorazione per livellatori e predisposizione per unione pannelli / Supplement for level adjuster and set up for panels joining
1	MP31	24,5	50,0	54,5	Scala angolare con 1 gradino / Corner stair with 1 step
1	MP96	22,0	50,0	56,5	Pedana con cassetto / Base with drawer
1	PR31	50,0	100,0	2,0	Protezione in metallo per soppalco / Metal protection for mezzanine
1	PR32	75,0	100,0	2,0	Protezione in metallo per soppalco / Metal protection for mezzanine
2	PR35	50,0	100,0	2,0	Rivestimento in tessuto con tasche per protezione PR31 e PR32 / Covering in fabric with pockets for protections PR31 and PR32
2	PX78	10,0	18,0	3,2	Maniglia rettangolare / Rectangular handle
1	PX79	10,0	18,0	3,2	Maniglia rettangolare con stampa digitale / Rectangular handle with digital print
1	S309A	66,2	226,0	104,0	Sistema trafilato per soppalco composizione 309A / Profiles system for mezzanine composition 309A
1	S309B	66,2	226,0	58,0	Sistema trafilato per soppalco composizione 309A / Profiles system for mezzanine composition 309A
1	S309C	141,2	213,0	100,0	Sistema trafilato per soppalco composizione 309A / Profiles system for mezzanine composition 309A
1	SC72	66,0	66,0	55,2	Scala a ventaglio per soppalco H.66.2 cm / Fan-shaped stair for mezzanine H.66.2 cm
1	SE10	97,0	65,0	65,0	Sedia con ruote e regolabile in altezza con scocca imbottita sfoderabile e basamento in metallo / Chair on castors adjustable in height with upholstered and removable structure and metal base
1	TBK32	6,5	125,0	2,0	Tubo appendiabiti in alluminio / Linear hanging rail in aluminium
1	TE08	50,0	98,0	10,0	Testata imbottita sfoderabile / Upholstered and removable headboard
1	UV99	100,0	175,3	0,1	Stampa digitale su pannello con immagine archivio Tumidei o cliente / Digital print on panel with image from Tumidei' library or from customer
1	UV99	100,0	100,0	0,1	Stampa digitale su pannello con immagine archivio Tumidei o cliente / Digital print on panel with image from Tumidei' library or from customer
1	ZM40	58,0	0,0	0,0	Apertura push-pull / Push-pull opening

INGOMBRI / DIMENSIONS

CONFIGURATION

309

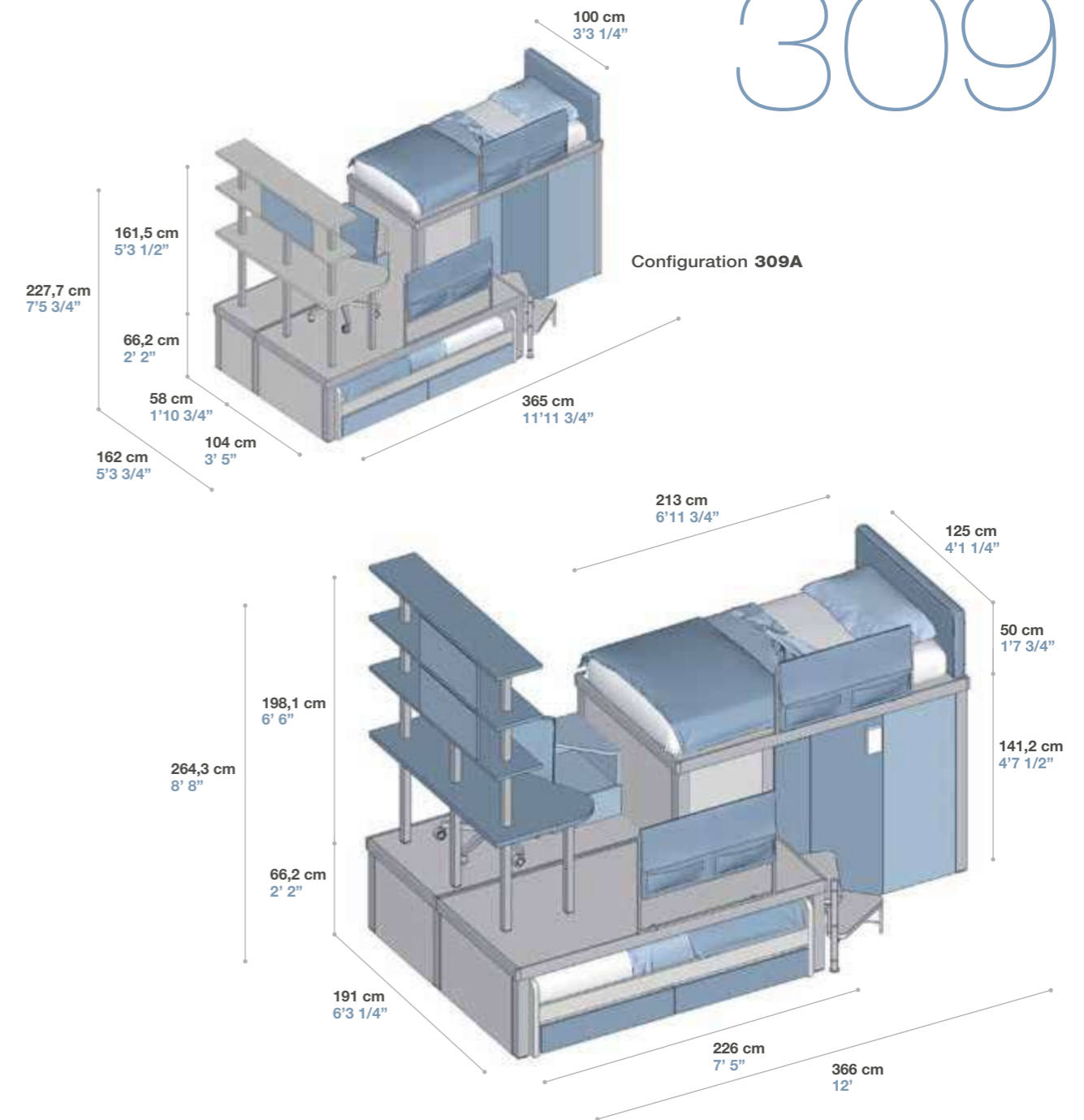

FINITURE / FINISHES

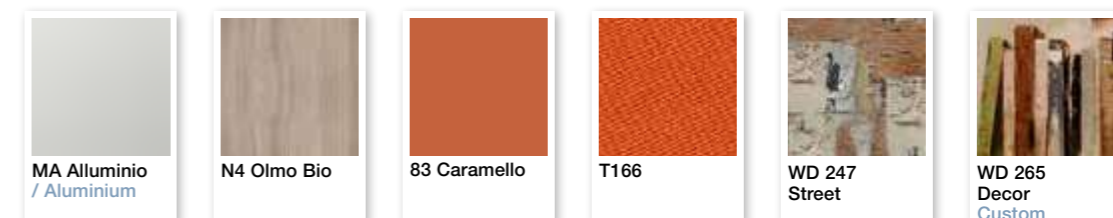

CONFIGURATION

310





DESCRIZIONE TECNICA / TECHNICAL DATA

Q.TA Q.TY	CODICE CODE	A / H	L / W	P / D	DESCRIZIONE / DESCRIPTION
1	B134	261,0	41,6	56,8	Colonna armadio 1 anta / Column wardrobe 1 door
1	B146	261,0	85,6	56,8	Colonna armadio 2 ante / Column wardrobe 2 doors
2	FN48	261,0	3,2	59,0	Fianco SYSTEM 32 / SYSTEM 32 Side
1	FN58	261,0	2,5	56,8	Divisore intermedio / Intermediate Partition
1	LK53	21,0	87,0	195,0	Letto BIG singolo estraibile scorrevole su ruote con rete a doghe / Single pull-out BIG bed sliding on castors with slats
1	LR32	53,2	96,6	203,5	Letto BIG singolo inferiore su ruote con rete a doghe / Lower single BIG bed sliding on castors with slats
1	MGLLK53	0,0	0,0	0,0	Maggiorazione per laccatura letto estraibile / Supplement for lacquered pull-out bed
1	MGLMQ5T	36,8	106,0	2,0	Maggiorazione laccatura schiena / Supplement for lacquered back
2	ML86	40,8	37,0	25,0	Mensola in metallo con fianchi e schiena in legno / Metal shelf with sides and wooden back
1	MQ68B	40,8	110,0	31,1	Elemento pensile orizzontale con 3 vani a giorno e 1 anta tripla / Horizontal wall box with 3 open sections and 1 triple door
1	MQA42	40,8	38,0	31,1	Elemento pensile orizzontale con 1 vano a giorno e 1 anta / Horizontal wall box with 1 open section and 1 door
1	MQA56	110,0	40,8	31,1	Elemento pensile verticale con 3 vani a giorno e 1 anta doppia / Vertical wall box with 3 open sections and 1 double door
2	PM42	1,5	33,8	3,5	Maniglia rettangolare / Rectangular handle
1	PR32	75,0	100,0	2,0	Protezione in metallo per soppalco / Metal protection for mezzanine
2	PUF4	46,0	40,0	40,0	Pouf con ruote / Pouf with castors
1	S134	66,2	226,0	125,0	Soppalco con piano trafilata H.66.2 cm / Mezzanine with profiles H.66.2 cm
1	SC72	66,0	66,0	55,2	Scala a ventaglio per soppalco H.66.2 cm / Fan-shaped stair for mezzanine H.66.2 cm
1	SV61	190,0	58,0	0,4	Specchio con stampa digitale di immagine archivio Tumidei / Mirror with digital print with image from Tumidei' library
1	SV62	190,0	58,0	0,4	Specchio con stampa digitale di immagine archivio Tumidei su 2 lati / Mirror with digital print with image from Tumidei' library on 2 sides
1	TQ82	24,0	166,6	59,0	Scrivania pensile spessore 4 cm con fascia H.20 cm / Wall desk thickness 4 cm with strip H.20 cm
1	VS23	40,0	40,0	20,5	Mensola T-BOX L 40 cm / T-BOX shelf W 40 cm
2	VS24	20,0	43,5	20,5	Mensola T-BOX L 43.5 cm / T-BOX shelf W 43.5 cm
2	VS24	20,0	43,5	20,5	Mensola T-BOX L 43.5 cm / T-BOX shelf W 43.5 cm

INGOMBRI / DIMENSIONS

CONFIGURATION
310

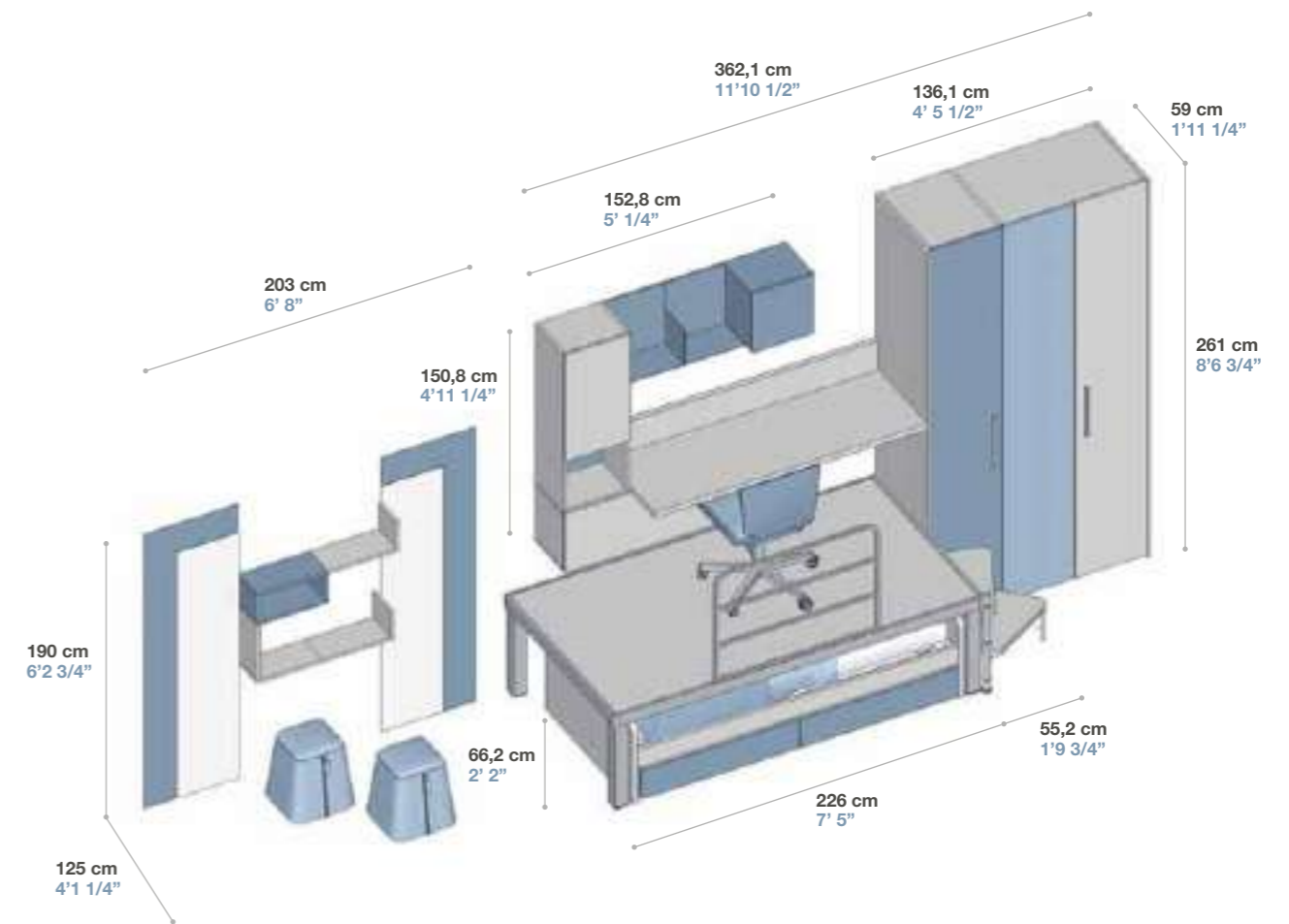

FINITURE / FINISHES

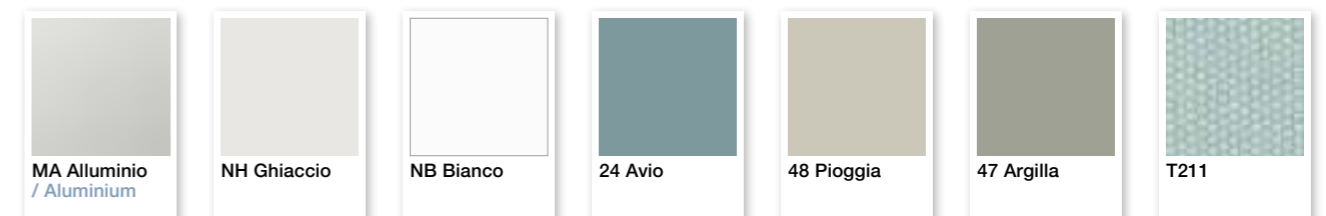

CONFIGURATION
311





DESCRIZIONE TECNICA / TECHNICAL DATA

Q.TA Q.TY	CODICE CODE	A / H	L / W	P / D	DESCRIZIONE / DESCRIPTION
1	B208	101,0	41,6	56,8	Colonna armadio 6 cassetti / Column wardrobe 6 drawers
3	B211	101,0	85,6	56,8	Colonna armadio 2 ante / Column wardrobe 2 doors
1	E189	134,0	150,0	33,4	Libreria con sistema a tubo quadro 5x5 / Bookcase with 5x5 square tube system
1	FER11	8,0	226,0	33,4	Maggiorazione per piani soppalco accoppiati / Supplement for joint tops-mezzanine
6	FN43	101,0	3,2	59,0	Fianco finale SYSTEM 32 / End side SYSTEM 32
1	FN53	101,0	2,5	56,8	Divisore intermedio / Intermediate Partition
1	GT60L	38,8	8,0	8,0	Tubo quadro 8x8 cm angolare o centrale con livellatore / Angular or central square tube 8x8 with level adjuster
2	GT63L	73,2	8,0	8,0	Tubo quadro 8x8 cm angolare o centrale con livellatore / Angular or central square tube 8x8 with level adjuster
4	GT6PL	106,2	8,0	8,0	Tubo quadro 8x8 cm angolare o centrale con livellatore / Angular or central square tube 8x8 with level adjuster
1	LB61	32,0	100,0	200,0	Letto singolo con trafilata scorrevole su ruote unidirezionali / Single bed with sliding profiles and one-way castors
2	LS03O	100,6	152,5	2,0	Pannello di chiusura orizzontale per soppalco / Horizontal closing panel for mezzanine
1	LS63	104,7	57,7	2,0	Pannello di chiusura laterale soppalco / Closing side panel for mezzanine
4	MG75	33,3	71,6	2,0	Anta scorrevole con guida / Sliding door with rail
4	MG86	33,8	2,0	27,6	Fianco di chiusura per anta scorrevole libreria / End side for sliding door in bookshelves
2	MP65N	56,0	56,0	20,0	Elemento orologio multivano pensile H.56 cm con ripiano in vetro / Wall multi-sections clock H.56 cm with glass shelf
6	PM42	1,5	33,8	3,5	Maniglia rettangolare / Rectangular handle
1	PR31	50,0	100,0	2,0	Protezione in metallo per soppalco / Metal protection for mezzanine
6	PX22	0,8	3,2	1,6	Maniglia rettangolare / Rectangular handle
1	S311A	109,2	213,0	101,5	Sistema trafilata per soppalco composizione 311 / Profiles system for mezzanine composition 311
1	S311B	66,2	226,0	106,5	Sistema trafilata per soppalco composizione 311 / Profiles system for mezzanine composition 311
1	S311C	66,2	226,0	106,5	Sistema trafilata per soppalco composizione 311 / Profiles system for mezzanine composition 311
1	S311D	109,2	213,0	101,5	Sistema trafilata per soppalco composizione 311 / Profiles system for mezzanine composition 311
2	SC72	66,0	66,0	55,2	Scala a ventaglio per soppalco H.66.2 cm / Fan-shaped stair for mezzanine H.66.2 cm
2	SE72	90,5	65,0	65,0	Sedia con ruote e regolabile in altezza con scocca in legno e basamento in metallo / Chair on castors adjustable in height with wooden structure and metal base
2	SE79	90,5	65,0	65,0	Seduta imbottita sfoderabile per SE72 e SE76 / Upholstered and removable seat for SE72 and SE76
2	TE12	70,0	98,0	10,0	Testata imbottita sfoderabile / Upholstered and removable headboard
1	TH56	8,0	150,0	80,0	Piano con sistema trafilata lineare in alluminio su 4 lati / Top with linear profiles in aluminium 4 sides
1	TH73	8,0	226,0	33,4	Piano con sistema trafilata lineare in alluminio su 4 lati / Top with linear profiles in aluminium 4 sides

INGOMBRI / DIMENSIONS

CONFIGURATION

311

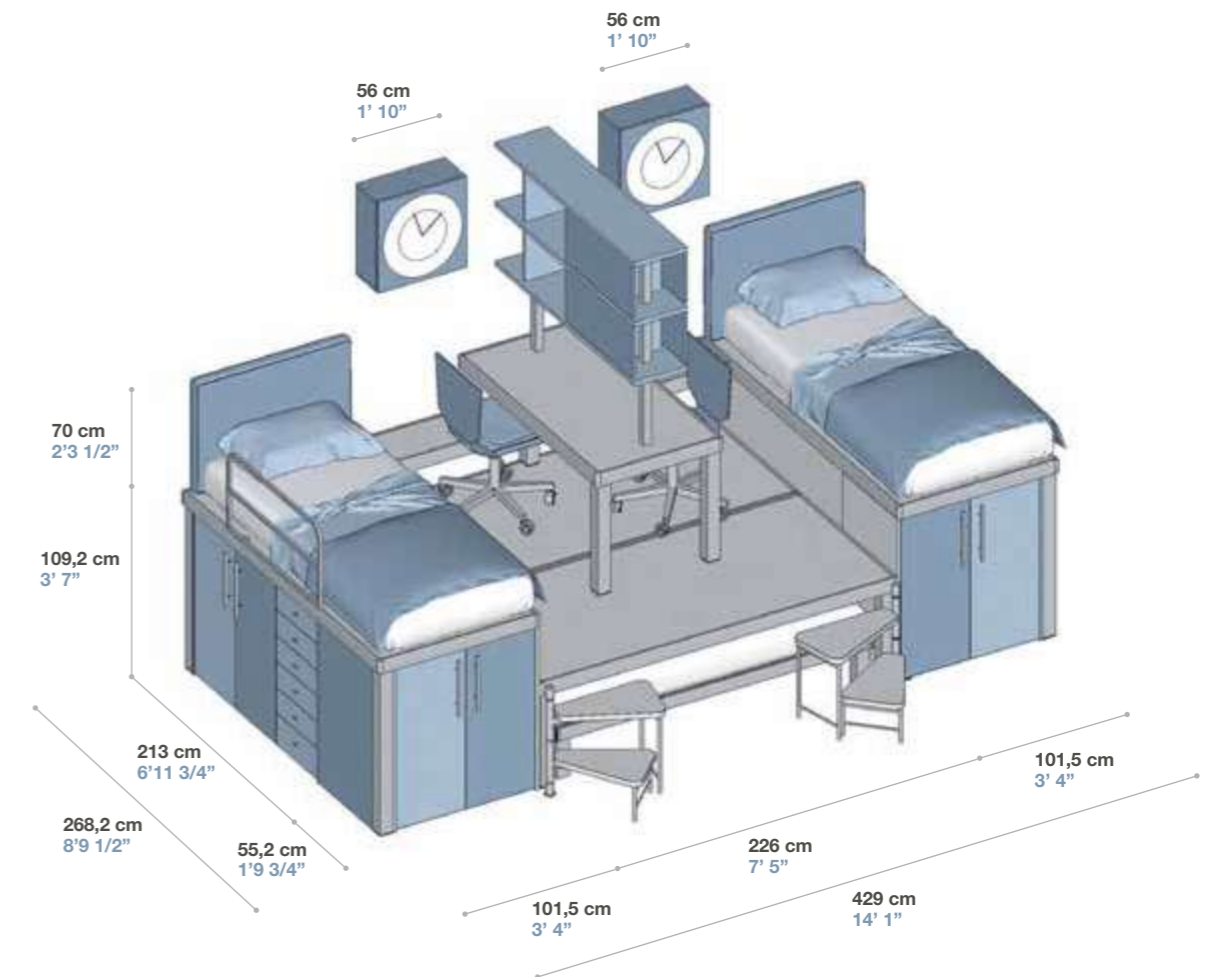

FINITURE / FINISHES

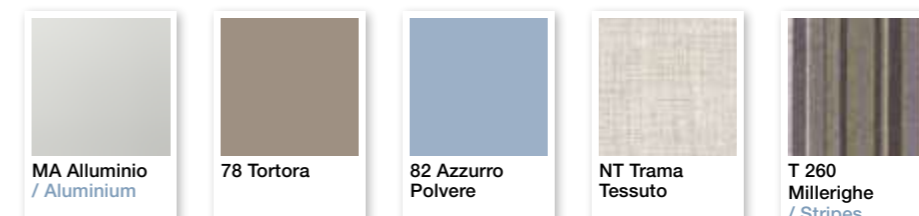

#ACTIVE TWIN

SOPPALCHI CON TRAFILA
Mezzanines with profiles



CONFIGURATION
312





Doppio scrittoio con mensola luminosa.
Double writing desk with light shelf.



Configuration 312

Grande cabina armadio con ripiani, specchio, cassettiera e luce interna.
Big dressing room with shelves, mirror, chest of drawers and internal light.





T-CLOUD è un sistema di contenitori parete, che grazie alla loro semplicità consente di ospitare e fornire servizi a molte delle funzioni che caratterizzano l'abitare di oggi: dalla musica, ai dati, alla ricarica di un device qualsiasi, al semplice contenimento di oggetti, il sistema infatti integra con intelligenza connessioni USB e alimentazioni di rete.

T-CLOUD is a system of wall storage boxes which, thanks to their simplicity, allows to provide with services to many functions making up the current way of life: music, data, recharge of any device, storage of object. In fact, the system brightly combines USB ports with power supplies.



Casse acustiche nascoste per un effetto "surround"

Hidden woofers for a "surround" effect



Predisposizioni per ricariche e collegamenti audio per tablet e smartphone

Sockets for recharges and audio connections for tablets and smartphones

DESCRIZIONE TECNICA / TECHNICAL DATA

Q.TA Q.TY	CODICE CODE	A / H	L / W	P / D	DESCRIZIONE / DESCRIPTION
1	B204	69,0	56,4	56,8	Colonna armadio 4 cassetti / Column wardrobe with 4 drawers
2	CSL06	34,0	81,5	43,7	Comodino a terra con 2 cassetti / Floor night table with 2 drawers
2	EZ43	106,0	3,0	31,6	Supporto metallico per 3 mensole / Metal support for 3 shelves
2	FN42	69,0	3,2	59,0	Fianco finale SYSTEM 32 / End side SYSTEM 32
3	KBR12	2,8	106,0	46,2	Mensola lineare / Linear shelf
1	LBB07	106,0	133,4	33,9	Elemento con 3 mensole e 2 supporti metallici / Element with 3 shelves and 2 metal supports
1	LS03O	42,0	194,0	2,0	Pannello di chiusura orizzontale per soppalco / Horizontal closing panel for mezzanine
1	LS03O	42,0	194,0	2,0	Pannello di chiusura orizzontale per soppalco / Horizontal closing panel for mezzanine
1	LS48	69,0	106,0	2,0	Pannello di chiusura laterale soppalco / Closing side panel for mezzanine
1	LS60	136,5	65,4	2,0	Pannello di chiusura laterale soppalco / Closing side panel for mezzanine
4	LSA03	136,5	97,0	2,0	Pannello di chiusura laterale soppalco / Closing side panel for mezzanine
2	LSA07	181,5	97,0	2,0	Pannello di chiusura laterale soppalco / Closing side panel for mezzanine
2	LSA07	181,5	106,0	2,0	Pannello di chiusura laterale soppalco / Closing side panel for mezzanine
1	LSA24	132,1	40,2	2,0	Anta singola per chiusura vano sotto soppalco / Single door to close under mezzanine area
1	LSA56	177,1	106,0	2,0	Ante a soffietto per chiusura vano sotto soppalco / Accordion doors to close under mezzanine area
1	MGT1	177,1	106,0	2,0	Maggiorazione per scasso su pannello di chiusura o anta / Supplements for carving on closing panel or door
2	MGT1	181,5	106,0	2,0	Maggiorazione per scasso su pannello di chiusura o anta / Supplements for carving on closing panel or door
1	MGT3	136,5	65,4	2,0	Maggiorazione per livellatore e predisposizione per fissaggio a trafilata / Supplement for level adjuster and set up for profiles fixing
4	MGT4	136,5	97,0	2,0	Maggiorazione per livellatori e predisposizione per unione pannelli / Supplement for level adjuster and set up for panels joining
2	MGT4	181,5	97,0	2,0	Maggiorazione per livellatori e predisposizione per unione pannelli / Supplement for level adjuster and set up for panels joining
1	MY04	4,0	202,0	59,2	Piano sagomato o lineare senza supporti laterali / Shaped or linear top
1	MY25	2,8	194,0	33,4	Mensola lineare a sbalzo sotto piano soppalco / Overhanging linear shelf under mezzanine
1	PR31	50,0	100,0	2,0	Protezione in metallo per soppalco / Metal protection for mezzanine
1	PR35	50,0	100,0	2,0	Rivestimento in tessuto con tasche per protezione PR31 e PR32 / Covering in fabric with pockets for protections PR31 and PR32
4	PX08	5,2	5,2	0,2	Maniglia ad incasso rettangolare con presa / Rectangular recessed handle with grip
4	PX09	5,2	19,4	0,2	Maniglia ad incasso rettangolare con presa / Recessed rectangular handle with grip
2	S146A	186,2	213,0	125,0	Sistema trafilata per soppalco composizione 312 / Profiles system for mezzanine composition 312
1	S146B	141,2	213,0	125,0	Sistema trafilata per soppalco composizione 312 / Profiles system for mezzanine composition 312
1	SC70	190,2	109,4	68,8	Scala a ventaglio per soppalco H.141.2 cm / Fan-shaped stair for mezzanine H.141.2 cm
2	SE10	97,0	65,0	65,0	Sedia con ruote e regolabile in altezza con scocca imbottita sfoderabile e basamento in metallo / Chair on castors adjustable in height with upholstered and removable structure and metal base
1	TBK33	6,5	200,0	2,0	Tubo appendiabiti in alluminio / Linear hanging rail in aluminium
1	TC02	130,0	130,0	27,5	Elemento pensile T-CLOUD con 8 vani a giorno / T-CLOUD wall box with 8 open sections
2	TC07	29,4	29,4	1,2	Copri diffusore / Loudspeaker cover
1	TC08	29,4	29,4	1,2	Pannello con collegamenti USB e alimentazione di rete / Panel with USB ports and power supply
2	TE13	70,0	123,0	10,0	Testata imbottita sfoderabile / Upholstered and removable headboard

INGOMBRI / DIMENSIONS

CONFIGURATION
312

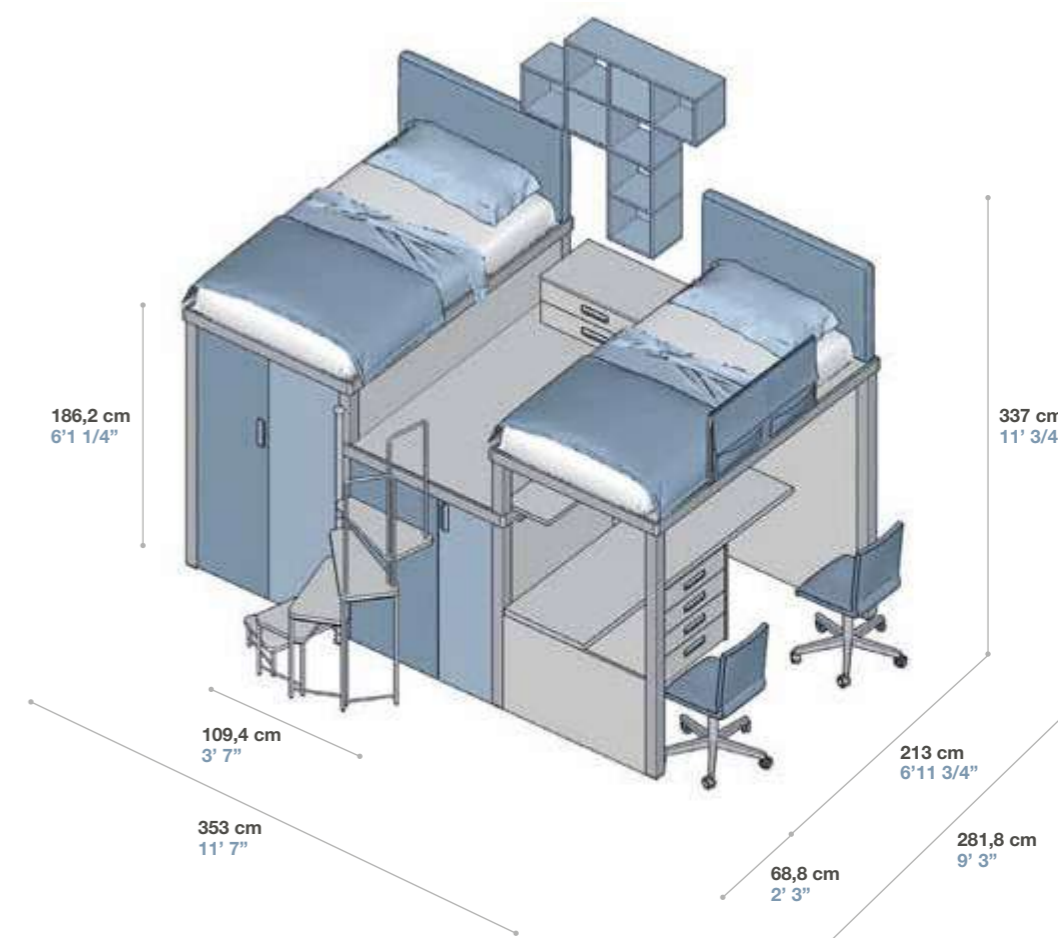

FINITURE / FINISHES

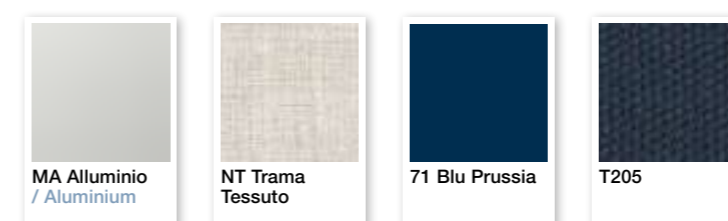

CONFIGURATION
313





DESCRIZIONE TECNICA / TECHNICAL DATA

Q.TA Q.TY	CODICE CODE	A / H	L / W	P / D	DESCRIZIONE / DESCRIPTION
2	GT82	29,0	8,0	8,0	Tubo quadro 8x8 cm con ruota unidirezionale per piani accoppiati / Square tube 8x8 cm with one-way castor for joint tops
1	LC79	171,6	136,8	2,0	Protezione in metallo per scala / Metal protection for stair
1	LCX1	134,2	43,0	169,8	Scala a 5 gradini con 3 cassetti per protezione LC79 / 5-steps stair with 3 drawers for protection LC79
1	LK56	21,0	88,0	191,0	Coppia cassetti estraibili su ruote / Couple of pull-out drawer on castors
4	LSA01	27,5	71,4	2,0	Pannello di chiusura laterale soppalco / Closing side panel for mezzanine
1	PR31	50,0	100,0	2,0	Protezione in metallo per soppalco / Metal protection for mezzanine
1	PR35	50,0	100,0	2,0	Rivestimento in tessuto con tasche per protezione PR31 e PR32 / Covering in fabric with pockets for protections PR31 and PR32
3	PX77	5,0	5,0	3,2	Maniglia quadrata / Square handle
1	S313	32,0	84,9	211,5	Sistema trafilato per composizione 313 / System of linear profiles for composition 313
1	S313C	141,2	125,0	233,4	Sistema trafilato singolo per sopplaco composizione 313 / Profiles system for mezzanine composition 313
1	TE09	50,0	123,0	10,0	Testata imbottita sfoderabile / Upholstered and removable headboard
2	TE36	50,0	82,9	10,0	Testata imbottita sfoderabile / Upholstered and removable headboard
1	VS01	20,0	74,0	20,5	Mensola T-BOX L 74 cm / T-BOX shelf W 74 cm

INGOMBRI / DIMENSIONS

CONFIGURATION

313

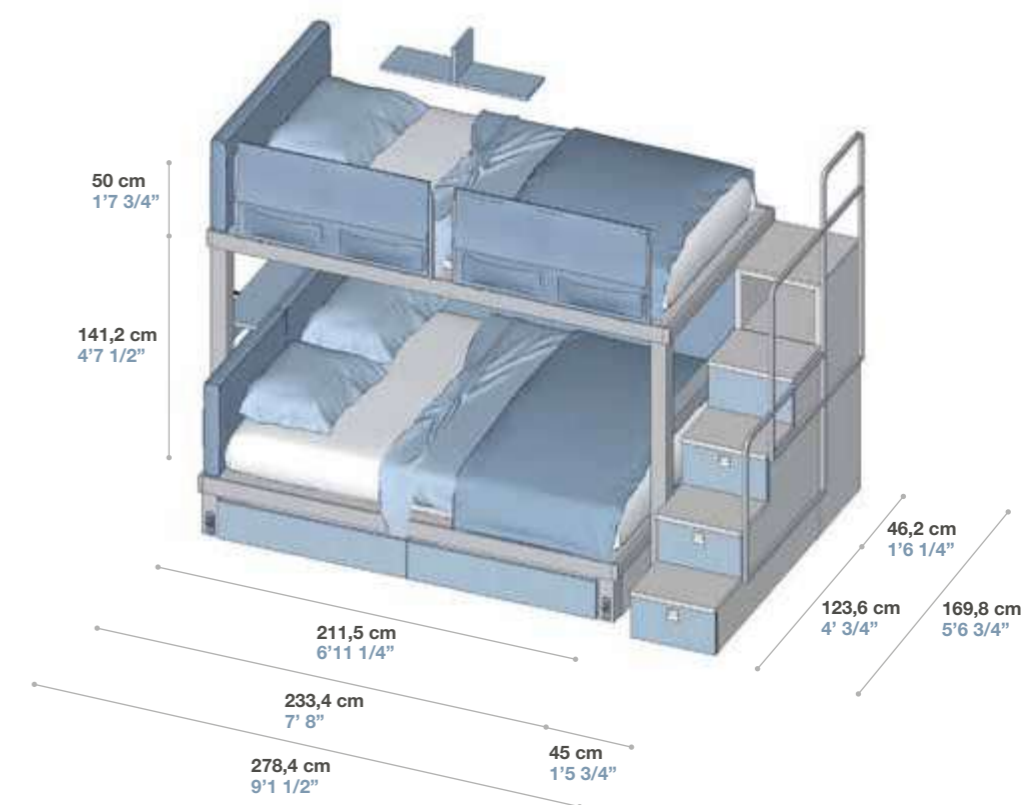

FINITURE / FINISHES

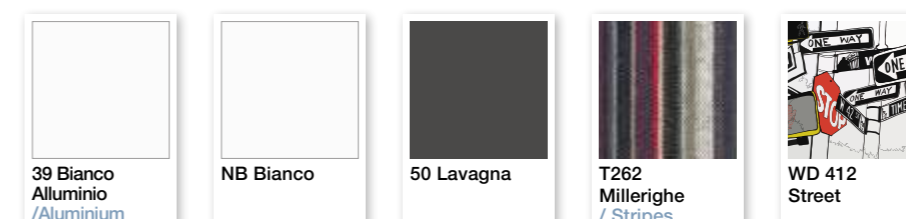

CONFIGURATION
314



SMART ITALIAN PROJECTS

Configuration 314





DESCRIZIONE TECNICA / TECHNICAL DATA

Q.TA Q.TY	CODICE CODE	A / H	L / W	P / D	DESCRIZIONE / DESCRIPTION
1	B208	101,0	41,6	56,8	Colonna armadio 6 cassetti / Column wardrobe 6 drawers
1	CSL06	34,0	81,5	43,7	Comodino a terra con 2 cassetti / Floor night table with 2 drawers
5	EZ41	38,4	3,0	31,6	Supporto metallico per 1 mensola / Metal support for 1 shelf
2	FN43	101,0	3,2	59,0	Fianco finale SYSTEM 32 / End side SYSTEM 32
1	GR23	73,2	4,0	59,0	Gamba telaio in metallo / Frame leg in metal
1	KBR12	2,8	106,0	46,2	Mensola lineare / Linear shelf
1	KBR44	2,8	147,8	46,2	Mensola lineare per cremagliera / Linear shelf for rack
1	LS48	104,5	85,4	2,0	Pannello di chiusura laterale soppalco / Closing side panel for mezzanine
2	LSA05	160,5	97,0	2,0	Pannello di chiusura laterale soppalco / Closing side panel for mezzanine
1	LSA05	161,8	106,0	2,0	Pannello di chiusura laterale soppalco / Closing side panel for mezzanine
2	LSA05	160,5	97,0	2,0	Pannello di chiusura laterale soppalco / Closing side panel for mezzanine
1	LSA43	100,1	81,0	2,0	Ante a soffietto per chiusura vano sotto soppalco / Accordion doors to close under mezzanine area
1	LSA55	156,0	106,0	2,0	Ante a soffietto per chiusura vano sotto soppalco / Accordion doors to close under mezzanine area
4	MGT4	160,5	97,0	2,0	Maggiorazione per livellatori e predisposizione per unione pannelli / Supplement for level adjuster and set up for panels joining
1	MJB902	4,0	115,0	90,0	Piano sagomato sp.4 cm / Shaped top th.4 cm
2	ML94	40,8	36,0	31,1	Contenitore pensile in metallo con 1 vano / Wall metal box with 1 section
3	MP96	22,0	50,0	56,5	Pedana con cassetto / Base with drawer
1	PR32	75,0	100,0	2,0	Protezione in metallo per soppalco / Metal protection for mezzanine
8	PX09	5,2	19,4	0,2	Maniglia ad incasso rettangolare con presa / Recessed rectangular handle with grip
1	S314A	165,2	213,0	125,0	Sistema trafia per soppalco composizione 314 / Profiles system for mezzanine composition 314
1	S314B	109,2	233,4	125,0	Sistema trafia per soppalco composizione 314 / Profiles system for mezzanine composition 314
1	SC74	170,0	98,4	64,5	Scala a ventaglio per soppalco H.109.2 cm / Fan-shaped stair for mezzanine H.109.2 cm
1	SE10	97,0	65,0	65,0	Sedia con ruote e regolabile in altezza con scocca imbottita sfoderabile e basamento in metallo / Chair on castors adjustable in height with upholstered and removable structure and metal base
1	TB8E	6,5	85,6	2,0	Tube appendiabiti in alluminio / Linear hanging rail in aluminium
1	TBK32	6,5	125,0	2,0	Tube appendiabiti in alluminio / Linear hanging rail in aluminium
1	VS01	20,0	74,0	20,5	Mensola T-BOX L 74 cm / T-BOX shelf W 74 cm
3	VS24	20,0	43,5	20,5	Mensola T-BOX L 43.5 cm / T-BOX shelf W 43.5 cm

INGOMBRI / DIMENSIONS

CONFIGURATION

314

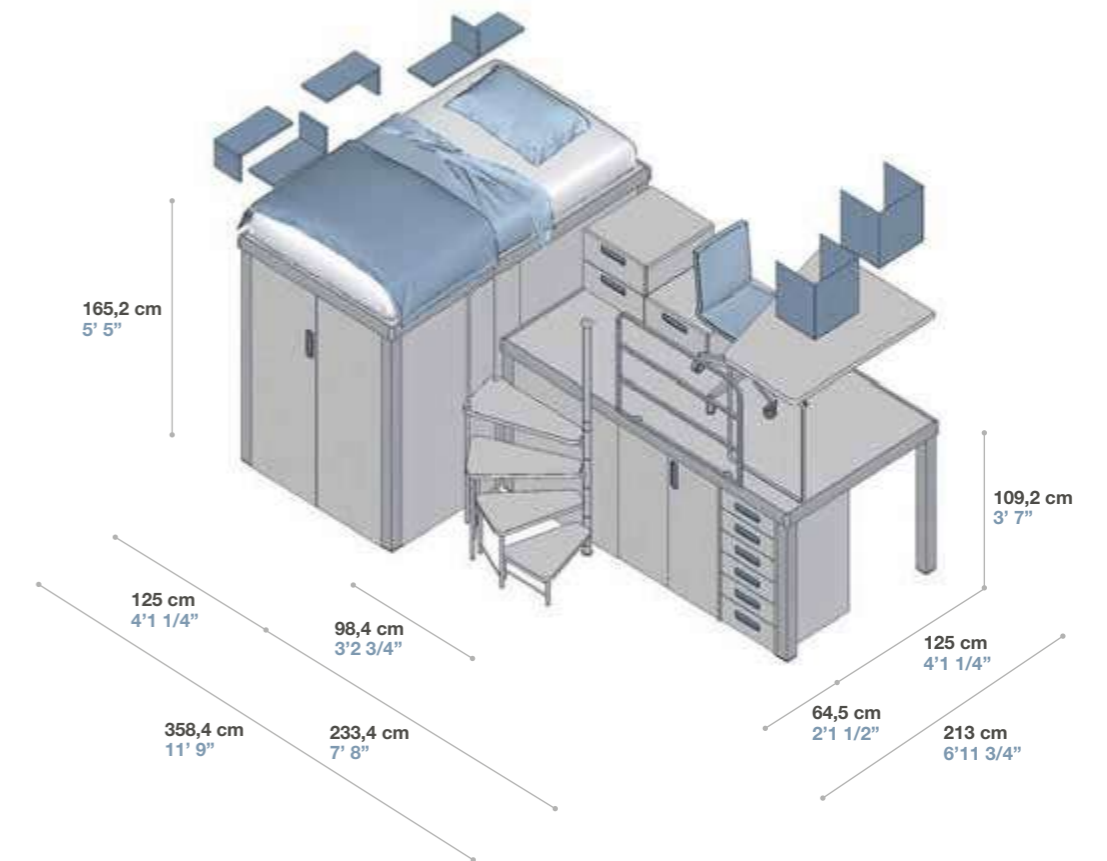

FINITURE / FINISHES



CONFIGURATION
315





SMART ITALIAN PROJECTS





Configuration 315



DESCRIZIONE TECNICA / TECHNICAL DATA

Q.TA Q.TY	CODICE CODE	A / H	L / W	P / D	DESCRIZIONE / DESCRIPTION
1	CSL06	34,0	81,5	43,7	Comodino a terra con 2 cassetti / Floor night table with 2 drawers
1	CSL25	34,0	52,3	43,7	Comodino con ruote e 2 cassetti / Night table on castors with 2 drawers
3	EZ41	38,4	3,0	31,6	Supporto metallico per 1 mensola / Metal support for 1 shelf
2	EZ42	72,2	3,0	31,6	Supporto metallico per 2 mensole / Metal support for 2 shelves
2	EZ43	106,0	3,0	31,6	Supporto metallico per 3 mensole / Metal support for 3 shelves
5	KBR12	2,8	106,0	46,2	Mensola lineare / Linear shelf
1	KBR14	2,8	194,0	46,2	Mensola lineare / Linear shelf
1	LS46	41,0	106,0	2,0	Pannello di chiusura laterale soppalco / Closing side panel for mezzanine
1	LSA03	136,5	98,0	2,0	Pannello di chiusura laterale soppalco / Closing side panel for mezzanine
2	LSA03	136,5	106,0	2,0	Pannello di chiusura laterale soppalco / Closing side panel for mezzanine
3	LSA07	181,5	97,0	2,0	Pannello di chiusura laterale soppalco / Closing side panel for mezzanine
1	LSA07	181,5	106,0	2,0	Pannello di chiusura laterale soppalco / Closing side panel for mezzanine
1	LSA54	132,1	98,0	2,0	Ante a soffietto per chiusura vano sotto soppalco / Accordion doors to close under mezzanine area
1	LSA56	177,1	97,0	2,0	Ante a soffietto per chiusura vano sotto soppalco / Accordion doors to close under mezzanine area
3	MGLTC13	30,0	30,0	2,0	Maggiorazione laccatura schiena / Supplement for back lacquering
2	MGT1	181,5	97,0	2,0	Maggiorazione per scasso su pannello di chiusura o anta / Supplements for carving on closing panel or door
2	MGT4	181,5	97,0	2,0	Maggiorazione per livellatori e predisposizione per unione pannelli / Supplement for level adjuster and set up for panels joining
1	MJB25	4,0	250,0	150,0	Piano sagomato MJB25 / Shaped desk MJB25
1	MQ66B	40,8	74,0	31,1	Elemento pensile orizzontale con 2 vani a giorno e 1 anta doppia / Horizontal wall box with 2 open sections and 1 double door
1	MQ68A	40,8	110,0	31,1	Elemento pensile orizzontale con 3 vani a giorno e 1 anta tripla / Horizontal wall box with 3 open sections and 1 triple door
1	PR31	50,0	100,0	2,0	Protezione in metallo per soppalco / Metal protection for mezzanine
1	PR32	75,0	100,0	2,0	Protezione in metallo per soppalco / Metal protection for mezzanine
2	PX28LN	4,0	80,0	0,2	Maniglia ad incasso rettangolare con fondo nobilitato e bordo laccato / Recessed rectangular handle with back in melamine and lacquered edge
1	S165B	141,2	117,0	125,0	Soppalco con piano trafilato H.141.2 cm / Mezzanine with profiles H.141.2 cm
1	S165A	186,2	213,0	125,0	Soppalco con piano trafilato a composizione / Profiles system for mezzanine
1	SC70	190,2	109,4	68,8	Scala a ventaglio per soppalco H.141.2 cm / Fan-shaped stair for mezzanine H.141.2 cm
1	SE72	90,5	65,0	65,0	Sedia con ruote e regolabile in altezza con scocca in legno e basamento in metallo / Chair on castors adjustable in height with wooden structure and metal base
1	SE79	90,5	65,0	65,0	Seduta imbottita sfoderabile per SE72 e SE76 / Upholstered and removable seat for SE72 and SE76
1	TBK02	6,5	98,8	2,0	Tubo appendiabiti in alluminio / Linear hanging rail in aluminium
1	TBK77	6,5	175,0	2,0	Tubo appendiabiti in alluminio / Linear hanging rail in aluminium
1	TC02	130,0	130,0	27,5	Elemento pensile T-CLOUD con 8 vani a giorno / T-CLOUD wall box with 8 open sections
1	TE13	70,0	123,0	10,0	Testata imbottita sfoderabile / Upholstered and removable headboard
3	TN69	73,2	36,2	59,0	Fianco angolare spessore 4 cm / Corner side thickness 4 cm
1	VS01	20,0	74,0	20,5	Mensola T-BOX L 74 cm / T-BOX shelf W 74 cm
3	VS24	20,0	43,5	20,5	Mensola T-BOX L 43.5 cm / T-BOX shelf W 43.5 cm

INGOMBRI / DIMENSIONS

CONFIGURATION
315

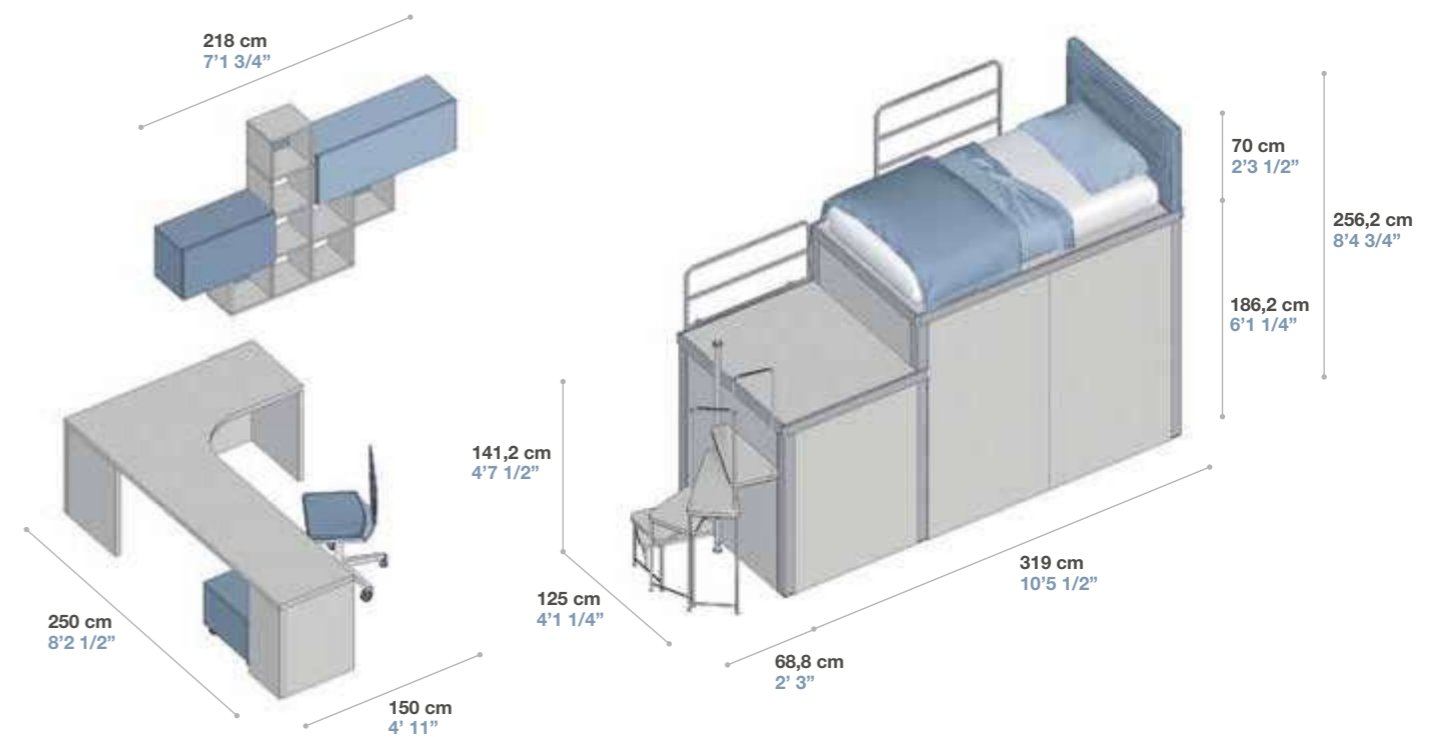

FINITURE / FINISHES



CONFIGURATION
316







DESCRIZIONE TECNICA / TECHNICAL DATA

Q.TA Q.TY	CODICE CODE	A / H	L / W	P / D	DESCRIZIONE / DESCRIPTION
1	B100	181,0	41,6	56,8	Colonna armadio 1 anta / Column wardrobe 1 door
1	B114	201,0	41,6	56,8	Colonna armadio 1 anta / Column wardrobe 1 door
1	B134	221,0	41,6	56,8	Colonna armadio 1 anta / Column wardrobe 1 door
1	B134	241,0	41,6	56,8	Colonna armadio 1 anta / Column wardrobe 1 door
1	B206	69,0	85,6	56,8	Colonna armadio 4 cassetti / Column wardrobe with 4 drawers
1	CSL05	34,0	52,3	43,7	Comodino a terra con 2 cassetti / Floor night table with 2 drawers
1	CSL06	34,0	81,5	43,7	Comodino a terra con 2 cassetti / Floor night table with 2 drawers
1	E187A	207,0	233,4	33,4	Libreria con sistema a tubo quadro / Bookcase with square tube system
2	EZ21	1,4	1,4	14,5	Reggimensola a scomparsa con foratura / Concealed bracket for shelf with drilling
3	EZ41	38,4	3,0	31,6	Supporto metallico per 1 mensola / Metal support for 1 shelf
4	EZ43	106,0	3,0	31,6	Supporto metallico per 3 mensole / Metal support for 3 shelves
2	FN42	69,0	3,2	59,0	Fianco finale SYSTEM 32 / End side SYSTEM 32
1	FN46	181,0	3,2	59,0	Fianco SYSTEM 32 / SYSTEM 32 Side
1	FN48	241,0	3,2	59,0	Fianco SYSTEM 32 / SYSTEM 32 Side
1	FN57	201,0	2,5	56,8	Divisore intermedio / Intermediate partition
1	FN57	221,0	2,5	56,8	Divisore intermedio / Intermediate partition
1	FN58	241,0	2,5	56,8	Divisore intermedio / Intermediate Partition
3	GH63	69,0	5,0	5,0	Tubo quadro 5x5 cm con piastra e piede per sostegno piani / Floor square tube 5x5 cm with plate and foot for tops support
1	GT94	42,2	8,0	8,0	Tubo quadro 8x8 cm intermedio per piani non complanari / Intermediate square tube 8x8 cm for non-coplanar tops
3	KBR02	2,8	87,0	33,4	Mensola lineare / Linear shelf
3	KBR03	2,8	130,0	33,4	Mensola lineare / Linear shelf
1	KBR03	2,8	160,0	33,4	Mensola lineare / Linear shelf
1	LS03V	41,5	131,0	2,0	Pannello di chiusura verticale per soppalco / Vertical closing panel for mezzanine
1	LS03V	136,5	131,0	2,0	Pannello di chiusura verticale per soppalco / Vertical closing panel for mezzanine
2	LS60	136,5	65,5	2,0	Pannello di chiusura laterale soppalco / Closing side panel for mezzanine
1	LSA06	181,5	55,0	2,0	Pannello di chiusura laterale soppalco / Closing side panel for mezzanine
1	LSA06	181,5	81,0	2,0	Pannello di chiusura laterale soppalco / Closing side panel for mezzanine
2	LSA07	181,5	97,0	2,0	Pannello di chiusura laterale soppalco / Closing side panel for mezzanine
1	LSA46	177,1	81,0	2,0	Ante a soffietto per chiusura vano sotto soppalco / Accordion doors to close under mezzanine area
1	MG76	33,3	105,0	2,0	Anta scorrevole con guida / Sliding door with rail
1	MGS4	0,1	0,1	0,1	Costo fisso di progettazione taglio per mansarda / Fixed cost for slanting cut design
3	MGS7	2,8	6,0	6,0	Maggiorazione per sagomatura a spigolo vivo non bordato / Supplement for sharp corner shaping with no edge
1	MGT1	181,5	55,0	2,0	Maggiorazione per scasso su pannello di chiusura o anta / Supplements for carving on closing panel or door
1	MGT1	181,5	81,0	2,0	Maggiorazione per scasso su pannello di chiusura o anta / Supplements for carving on closing panel or door
2	MGT4	181,5	97,0	2,0	Maggiorazione per livellatori e predisposizione per unione pannelli / Supplement for level adjuster and set up for panels joining
4	MGT50	0,1	0,1	0,1	Maggiorazione 1 taglio obliquo per mansarda su ante battenti / Supplement for 1 slanting cut for mansard on hinged doors
1	MJB905	4,0	220,0	180,0	Piano sagomato sp.4 cm COMPO 905 / Shaped top th. 4 cm COMPO 905
1	PR32	75,0	100,0	2,0	Protezione in metallo per soppalco / Metal protection for mezzanine
1	PR35	50,0	100,0	2,0	Rivestimento in tessuto con tasche per protezione PR31 e PR32 / Covering in fabric with pockets for protections PR31 and PR32
4	PX09	5,2	19,4	0,2	Maniglia ad incasso rettangolare con presa / Recessed rectangular handle with grip
2	PX25LL	4,0	8,0	0,2	Maniglia ad incasso rettangolare con fondo e bordo laccato / Recessed rectangular handle with lacquered back and edge
5	PX28LL	4,0	80,0	0,2	Maniglia ad incasso rettangolare con fondo e bordo laccato / Recessed rectangular handle with lacquered back and edge
1	S158A	186,2	213,0	100,0	Sistema trafia per soppalco / Profiles system for mezzanine
1	S158B	141,2	150,0	84,5	Sistema trafia per soppalco / Profiles system for mezzanine
1	SC70	190,2	109,4	68,8	Scala a ventaglio per soppalco H.141.2 cm / Fan-shaped stair for mezzanine H.141.2 cm
1	SE72	90,5	65,0	65,0	Sedia con ruote e regolabile in altezza con scocca in legno e basamento in metallo / Chair on castors adjustable in height with wooden structure and metal base
1	SE79	90,5	65,0	65,0	Seduta imbottita sfoderabile per SE72 e SE76 / Upholstered and removable seat for SE72 and SE76
1	TE12	70,0	98,0	10,0	Testata imbottita sfoderabile / Upholstered and removable headboard
1	UV99	100,0	176,7	0,1	Stampa digitale su pannello con immagine archivio Tumidei o cliente / Digital print on panel with image from Tumidei library or from customer
1	VS01	20,0	74,0	20,5	Mensola T-BOX L 74 cm / T-BOX shelf W 74 cm
3	VS24	20,0	43,5	20,5	Mensola T-BOX L 43.5 cm / T-BOX shelf W 43.5 cm

INGOMBRI / DIMENSIONS

CONFIGURATION

316

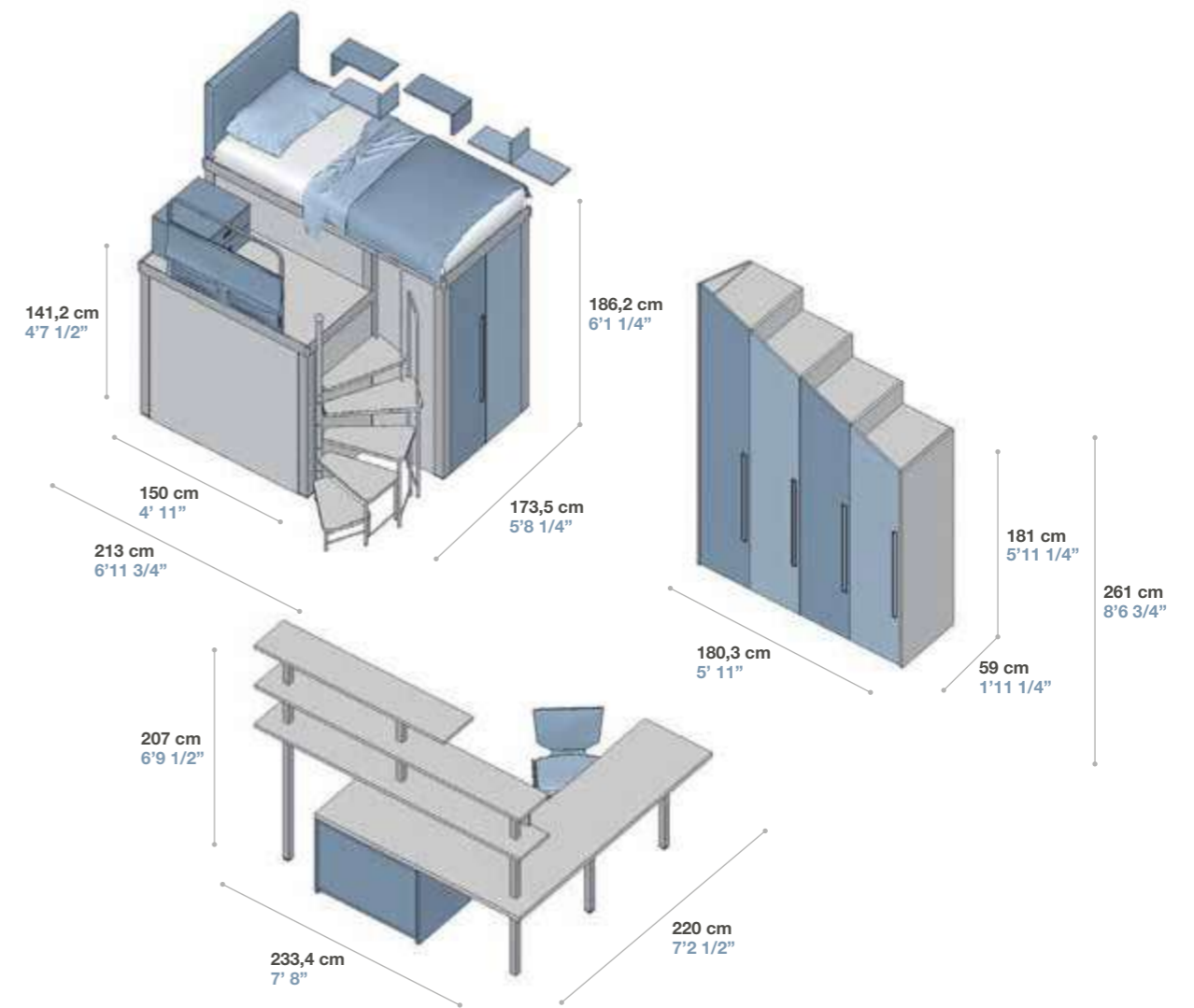

FINITURE / FINISHES

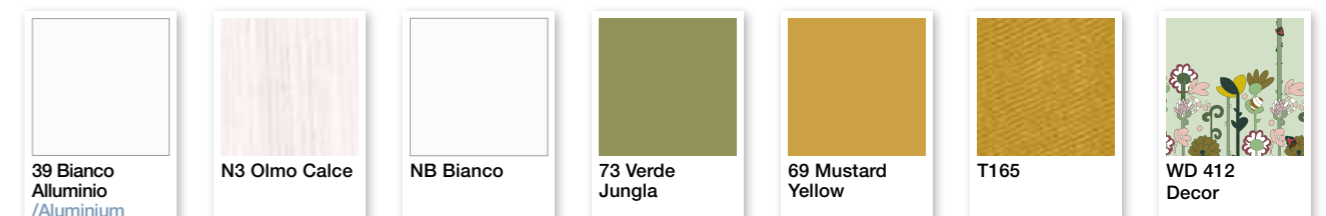

#TRENDY BOY AND GIRL

LETTI SCORREVOLI CON TRAFILA

Sliding beds with profiles



CONFIGURATION
317





DESCRIZIONE TECNICA / TECHNICAL DATA

Q.TA Q.TY	CODICE CODE	A / H	L / W	P / D	DESCRIZIONE / DESCRIPTION
1	B209	101,0	56,4	56,8	Colonna armadio 1 anta / Column wardrobe with 1 door
1	B210	101,0	56,4	56,8	Colonna armadio 6 cassetti / Column wardrobe with 6 drawers
1	B224	133,0	56,4	56,8	Colonna armadio 1 anta / Column wardrobe with 1 door
1	BF59	145,2	100,0	226,0	Letto superiore scorrevole su guida / Upper sliding bed on rail
1	FF44	133,0	2,8	46,2	Fianco SYSTEM 28 / SYSTEM 28 Side
3	FN43	101,0	3,2	59,0	Fianco finale SYSTEM 32 / End side SYSTEM 32
1	FN54	133,0	2,5	56,8	Divisore intermedio / Intermediate partition
1	FN73	101,0	1,2	56,8	Fianco spessore 1,2 cm / Side thickness 1,2 cm
1	FN74	133,0	1,2	56,8	Fianco spessore 1,2 cm / Side thickness 1,2 cm
1	FT20	30,8	59,0	2,0	Pannello generico a mq sp. 20 / General panel per sqm th. 20
1	GSV33	7,3	198,0	4,0	Guida di scorrimento DRIVE in alluminio / DRIVE sliding rail in aluminium
1	GT63L	73,2	8,0	8,0	Tubo quadro 8x8 cm angolare o centrale con livellatore / Angular or central square tube 8x8 with level adjuster
1	KCA29	133,0	87,6	56,8	Cabina armadio lineare CARRY tipo 1 / CARRY linear closet type 1
1	LCX1	134,2	43,0	169,8	Scala a 5 gradini con 3 cassetti per protezione LC79 / 5-steps stair with 3 drawers for protection LC79
1	LS48	104,5	106,0	2,0	Pannello di chiusura laterale soppalco / Closing side panel for mezzanine
1	LSA33	100,1	52,7	2,0	Anta singola per chiusura vano sotto soppalco / Single door to close under mezzanine area
1	MGSP02	30,8	59,0	2,0	Maggiorazione per spinatura / Supplement for doweling
1	MGT3	104,5	106,0	2,0	Maggiorazione per livellatore e predisposizione per fissaggio a trafilatura / Supplement for level adjuster and set up for profiles fixing
1	MGT91	0,0	0,0	0,0	Maggiorazione aumento in larghezza pannello Carry / Supplement for increasing width of Carry panel
1	MJB21	4,0	171,3	119,2	Piano sagomato MJB21 / Shaped desk MJB21
1	PUF9	41,5	170,0	5,0	Formella imbottita sfoderabile / Upholstered and removable shape
1	PX18	5,5	6,2	2,5	Maniglia triangolare / Triangular handle
1	PX71	7,0	7,0	2,0	Maniglia a forma T / T-shaped handle
7	PX77	5,0	5,0	3,2	Maniglia quadrata / Square handle
4	PX78	10,0	18,0	3,2	Maniglia rettangolare / Rectangular handle
1	Q500	101,0	65,2	46,2	Colonna libreria SYSTEM 28 con schiena da comp. 317 / SYSTEM 28 bookcase column with back from comp. 317
1	Q509	133,0	90,8	46,2	Colonna libreria SYSTEM 28 con schiena da comp. 317 / SYSTEM 28 bookcase column with back from comp. 317
1	S148	109,2	200,0	125,0	Sopralco con piano trafilatura H.109,2 cm / Mezzanine with profiles H.109.2 cm
2	SE10	97,0	65,0	65,0	Sedia con ruote e regolabile in altezza con scocca imbottita sfoderabile e basamento in metallo / Chair on castors adjustable in height with upholstered and removable structure and metal base
1	TE08	50,0	98,0	10,0	Testata imbottita sfoderabile / Upholstered and removable headboard
1	TS88M	1,2	93,3	46,4	Top di finitura costo minimo / Finishing top minimum cost
1	TS89	1,2	152,3	59,2	Top di finitura / Finishing top
1	TS89M	1,2	60,2	59,2	Top di finitura costo minimo / Finishing top minimum cost

INGOMBRI / DIMENSIONS

CONFIGURATION

317

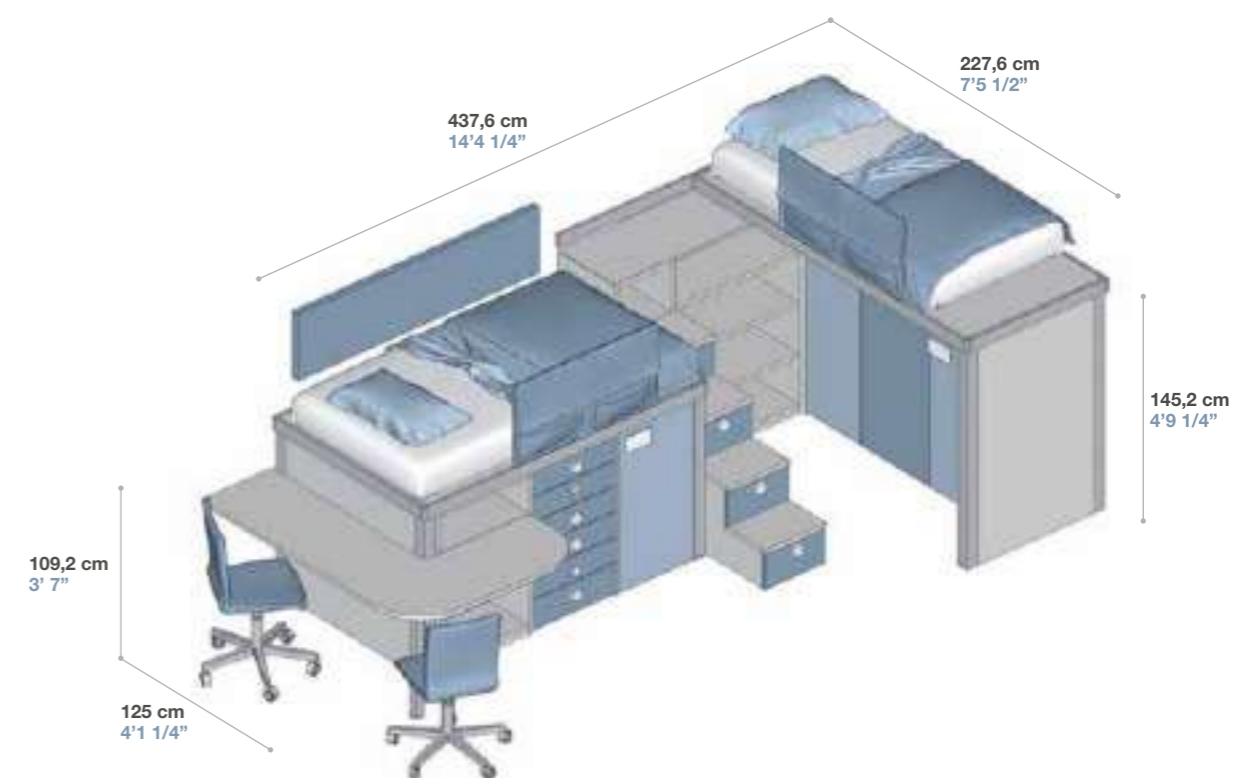

FINITURE / FINISHES

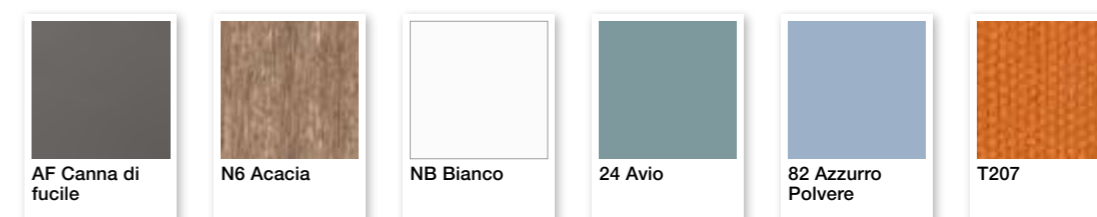





DESCRIZIONE TECNICA / TECHNICAL DATA

Q.TA Q.TY	CODICE CODE	A / H	L / W	P / D	DESCRIZIONE / DESCRIPTION
1	BF58	145,2	100,0	213,0	Letto superiore scorrevole su guida / Upper sliding bed on rail
1	FF34	133,0	2,8	33,4	Fianco SYSTEM 28 / SYSTEM 28 Side
1	GH63	73,2	5,0	5,0	Tubo quadro 5x5 cm con piastra e piede per sostegno piani / Floor square tube 5x5 cm with plate and foot for tops support
1	GSV33	7,3	180,0	4,0	Guida di scorrimento DRIVE in alluminio / DRIVE sliding rail in aluminium
1	KKJ6	3,0	100,0	3,0	Supporto angolare in alluminio / Corner support in aluminium
1	LCX1	134,2	43,0	169,8	Scala a 5 gradini con 3 cassetti per protezione LC79 / 5-steps stair with 3 drawers for protection LC79
1	LCY3	102,0	2,0	124,0	Pannello laterale per scala / Side panel for stair
1	LW36X	41,4	99,5	211,0	Letto SYSTEM SCRIGNO singolo imbottito fisso / SYSTEM SCRIGNO upholstered single fixed bed
1	MJB22	4,0	200,0	90,0	Piano sagomato / Shaped desk
1	PR31	50,0	100,0	2,0	Protezione in metallo per soppalco / Metal protection for mezzanine
1	PR35	50,0	100,0	2,0	Rivestimento in tessuto con tasche per protezione PR31 e PR32 / Covering in fabric with pockets for protections PR31 and PR32
3	PX77	5,0	5,0	3,2	Maniglia quadrata / Square handle
2	SE10	97,0	65,0	65,0	Sedia con ruote e regolabile in altezza con scocca imbottita sfoderabile e basamento in metallo / Chair on castors adjustable in height with upholstered and removable structure and metal base
1	T516	55,8	46,8	33,4	Colonna libreria SYSTEM 28 da comp. 318 / Bookcase column SYSTEM 28 from comp. 318
1	T517	133,0	90,8	33,4	Colonna libreria SYSTEM 28 da comp. 318 / Bookcase column SYSTEM 28 from comp. 318
1	T518	133,0	90,8	33,4	Colonna libreria SYSTEM 28 da comp. 318 / Bookcase column SYSTEM 28 from comp. 318
1	T519	73,2	46,8	33,4	Colonna libreria SYSTEM 28 da comp. 318 / Bookcase column SYSTEM 28 from comp. 318
1	TE08	50,0	98,0	10,0	Testata imbottita sfoderabile / Upholstered and removable headboard
1	TS87	1,2	231,6	33,6	Top di finitura / Finishing top
1	UV99	100,0	113,7	0,1	Stampa digitale su pannello con immagine archivio Tumidei o cliente / Digital print on panel with image from Tumidei' library or from customer

INGOMBRI / DIMENSIONS

CONFIGURATION
318

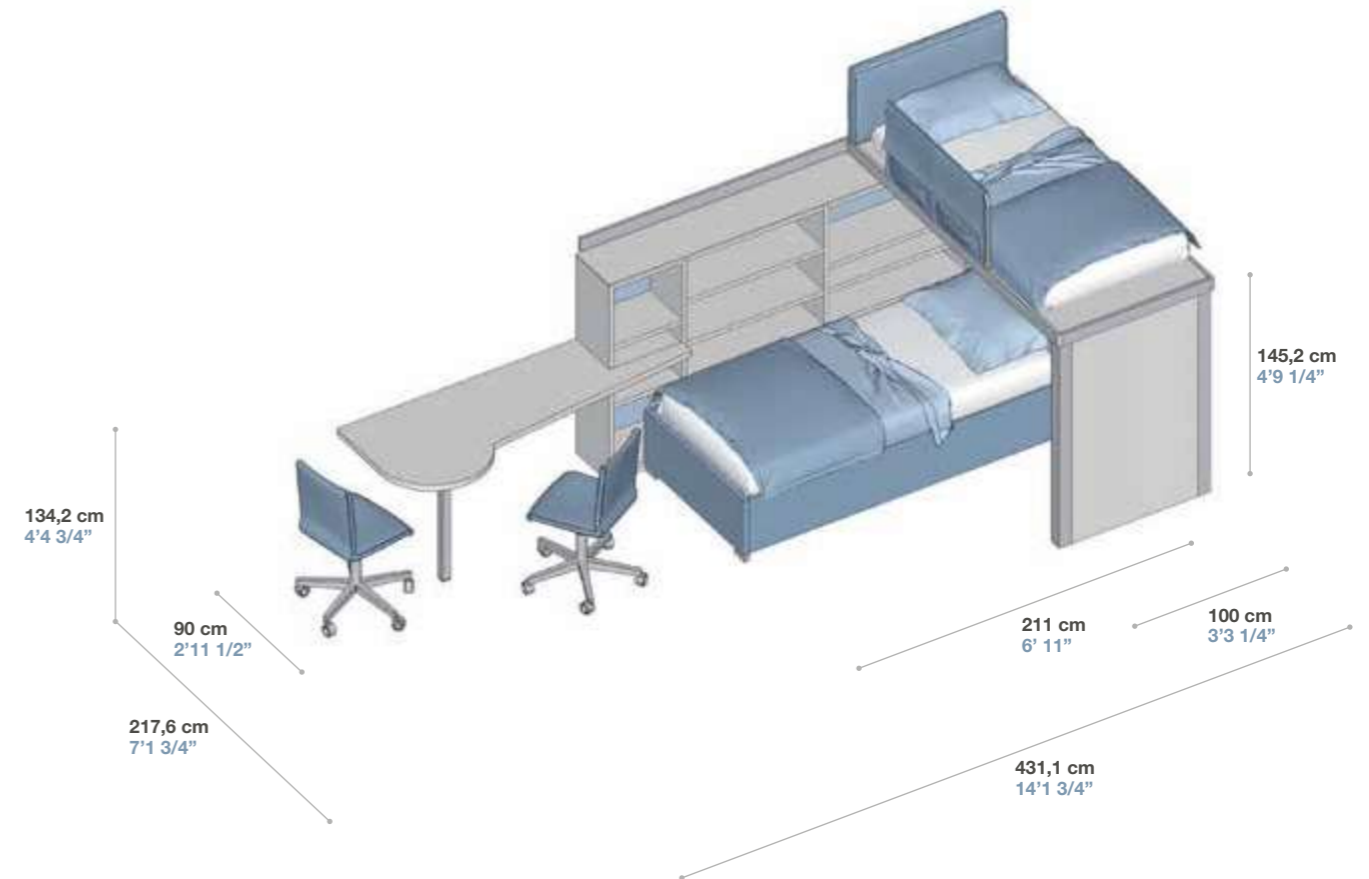

FINITURE / FINISHES

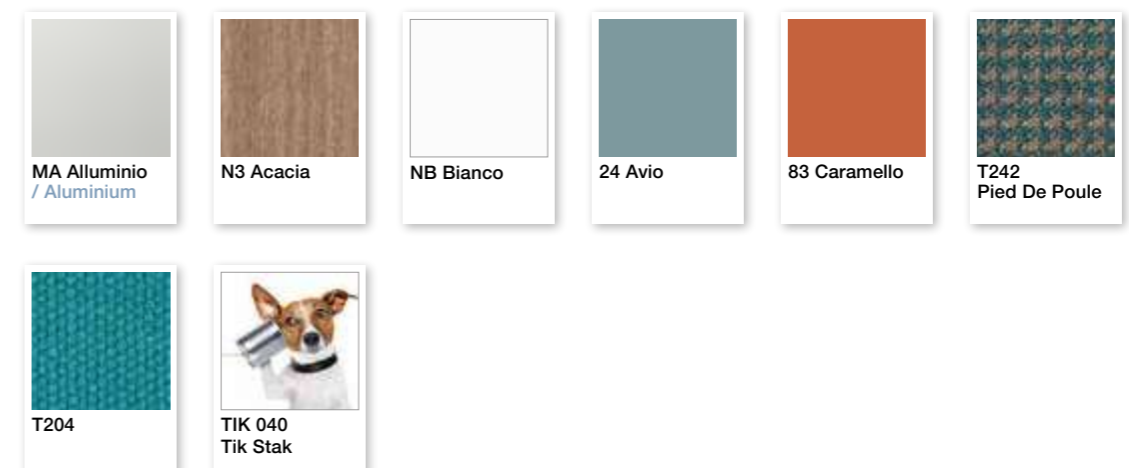





Configuration 319



BLUETOOTH SOUND SYSTEM

Nel programma Tiramolla, le casse acustiche, sono integrate nella trafila. Il sistema Bluetooth, ne consente la connessione a tutti i device.

In the Tiramolla program, the speakers are integrated in the profiles. The bluetooth system allows the connection with all the devices.



DRIVE

Una guida a scomparsa funzionale e luminosa. Drive è personalizzabile in tutti i colori laccati della gamma Tumidei, diventando un elemento decorativo e minimale. Non solo guida gli elementi della camera ma crea un'ambiente caldo e funzionale.

This concealed rail is functional and lighting. Drive can be customized in all the lacquered colours of the Tumidei collection, getting a minimalistic and decorative element. Not only it drives the bedroom elements, but it creates a warm and functional environment.

DESCRIZIONE TECNICA / TECHNICAL DATA

Q.TA Q.TY	CODICE CODE	A / H	L / W	P / D	DESCRIZIONE / DESCRIPTION
1	B183	101,0	56,4	56,8	Colonna armadio 2 cassetti e 2 cassettoni / Column wardrobe with 2 doors and 2 high drawers
1	B224	133,0	56,4	56,8	Colonna armadio 1 anta / Column wardrobe with 1 door
1	BF55	143,7	105,0	222,0	Letto superiore scorrevole su guida / Upper sliding bed on rail
1	CSL06	34,0	81,5	43,7	Comodino a terra con 2 cassetti / Floor night table with 2 drawers
1	FF44	133,0	2,8	46,2	Fianco SYSTEM 28 / SYSTEM 28 Side
1	FNA02	32,0	2,0	61,0	Fianco SYSTEM 20 / SYSTEM 20 Side
1	FT12	61,2	58,9	1,2	Pannello generico a mq sp. 12 / General panel per sqm th. 12
1	FT12	61,2	157,5	1,2	Pannello generico a mq sp. 12 / General panel per sqm th. 12
1	GSV36	7,3	320,0	4,0	Guida di scorrimento DRIVE in alluminio / DRIVE Sliding rail in aluminium
1	IM81	10,0	4,0	0,2	Impianto audio per tubo quadro / Sound system for square tube
1	KCA29	133,0	87,6	56,8	Cabina armadio lineare CARRY tipo 1 / CARRY linear closet type 1
2	LC79	171,6	136,8	2,0	Protezione in metallo per scala / Metal protection for stair
2	LCX1	134,2	43,0	169,8	Scala a 5 gradini con 3 cassetti per protezione LC79 / 5-steps stair with 3 drawers for protection LC79
1	LS60	132,6	60,1	2,0	Pannello di chiusura laterale soppalco / Closing side panel for mezzanine
1	LS63	100,6	60,8	2,0	Pannello di chiusura laterale soppalco / Closing side panel for mezzanine
1	LSA03	132,6	95,1	2,0	Pannello di chiusura laterale soppalco / Closing side panel for mezzanine
1	LSA05	160,5	88,0	2,0	Pannello di chiusura laterale soppalco / Closing side panel for mezzanine
2	LSA05	160,5	97,0	2,0	Pannello di chiusura laterale soppalco / Closing side panel for mezzanine
2	LSA05	160,5	106,0	2,0	Pannello di chiusura laterale soppalco / Closing side panel for mezzanine
1	LSA55	156,1	106,0	2,0	Ante a soffietto per chiusura vano sotto soppalco / Accordion doors to close under mezzanine area
1	LT9M	8,3	25,0	4,0	Coppia carrelli per guida DRIVE / Couple of truck for DRIVE rail
2	MGS7	2,8	1,4	3,0	Maggiorazione per sagomatura a spigolo vivo non bordato / Supplement for sharp corner shaping with no edge
1	MGSP02	61,2	58,9	1,2	Maggiorazione per spinatura / Supplement for doweling
1	MGSP02	61,2	157,5	1,2	Maggiorazione per spinatura / Supplement for doweling
1	MJB23	4,0	160,0	85,0	Piano sagomato MJB23 / Shaped desk MJB23
1	MY04	4,0	50,4	46,2	Piano sagomato o lineare senza supporti laterali / Shaped or linear top
2	PR31	50,0	100,0	2,0	Protezione in metallo per soppalco / Metal protection for mezzanine
2	PR35	50,0	100,0	2,0	Rivestimento in tessuto con tasche per protezione PR31 e PR32 / Covering in fabric with pockets for protections PR31 and PR32
13	PX09	5,2	19,4	0,2	Maniglia ad incasso rettangolare con presa / Recessed rectangular handle with grip
1	PZA40	2,8	144,7	46,2	Mensola sp. 2.8 cm al metro lineare per boiserie / Shelf th. 2.8 cm per linear meter for wall panel
2	PZA48	2,8	106,8	46,2	Mensola LUDO con supporti laterali / LUDO shelf with lateral supports
4	PZA83	8,5	0,3	29,2	Supporto intermedio per mensole LUDO / Intermediate support for LUDO shelves
4	PZA85	164,6	1,6	3,0	Creomaglieria LUDO dotata di piedini regolabili in altezza / LUDO rack provided with feet adjustable in height
2	Q494	59,8	81,8	46,2	Colonna libreria SYSTEM 28 con vani a giorno sopra piano da comp. 319 / Bookcase column SYSTEM 28 with open sections on desk from comp. 319
1	Q495	59,8	46,8	46,2	Colonna libreria SYSTEM 28 da comp. 319 / Bookcase column SYSTEM 28 from comp. 319
2	Q496	69,2	81,8	46,2	Colonna libreria SYSTEM 28 con vani a giorno sotto piano da comp. 319 / Bookcase column SYSTEM 28 with open sections under desk from comp. 319
1	Q497	69,2	46,8	46,2	Colonna libreria SYSTEM 28 con vani a giorno sotto piano da comp. 319 / Bookcase column SYSTEM 28 with open sections under desk from comp. 319
1	S319A	165,2	213,0	125,0	Soppalco con piano trafila / Mezzanine with profiles
1	SE10	97,0	65,0	65,0	Sedia con ruote e regolabile in altezza con scocca imbottita sfoderabile e basamento in metallo / Chair on castors adjustable in height with upholstered and removable structure and metal base
1	TE07	50,0	103,0	10,0	Testata imbottita sfoderabile / Upholstered and removable headboard
1	TE09	50,0	123,0	10,0	Testata imbottita sfoderabile / Upholstered and removable headboard
1	TS88	1,2	213,2	46,4	Top di finitura / Finishing top
2	VS25	20,0	56,5	20,5	Mensola T-BOX L 56.5 cm / T-BOX shelf W 56.5 cm
1	VS26	20,0	100,0	20,5	Mensola T-BOX L 100 cm / T-BOX shelf W 100 cm

INGOMBRI / DIMENSIONS

CONFIGURATION

319

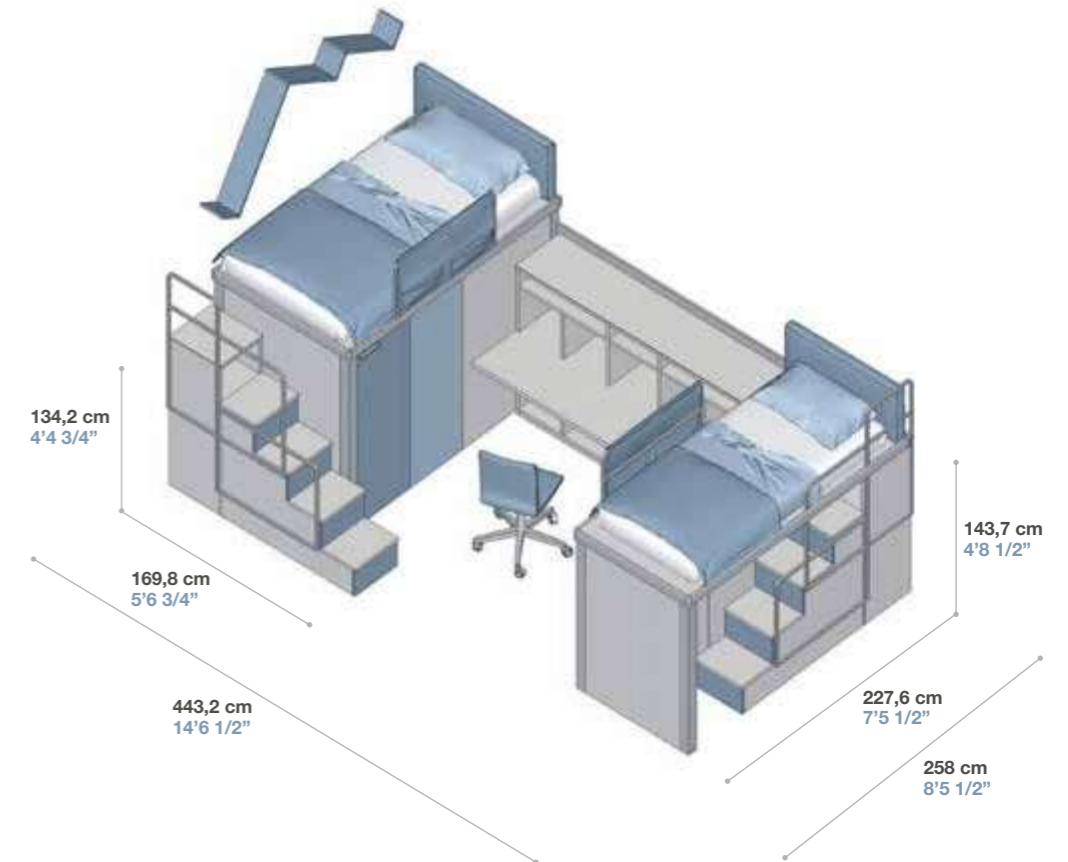

FINITURE / FINISHES

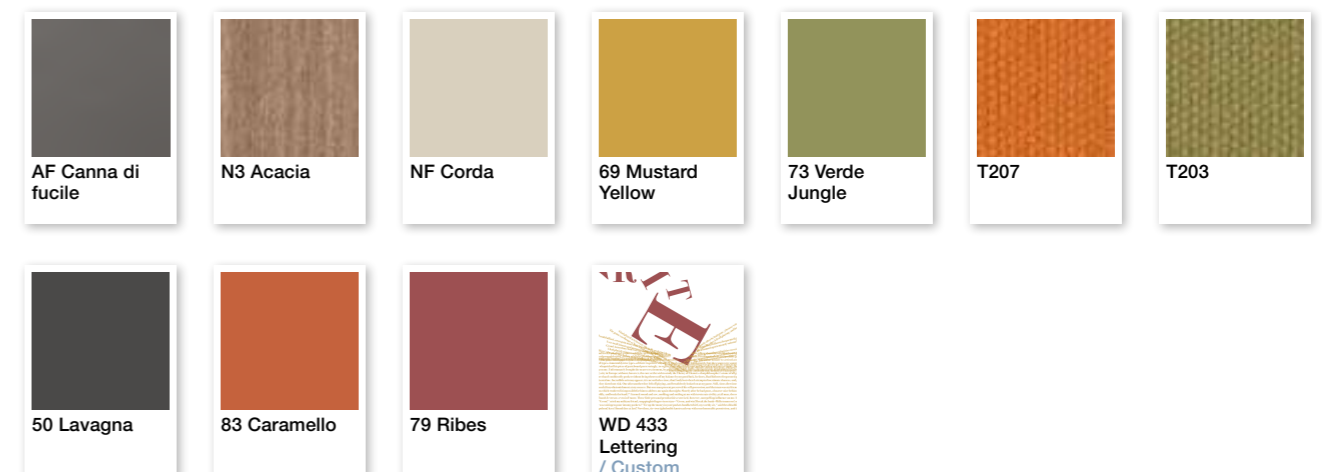

#COLLEGE STUDENT

LETTI SCORREVOLI CON TRAFILA
Sliding beds with profiles



Configuration 320

CONFIGURATION
320







DESCRIZIONE TECNICA / TECHNICAL DATA

Q.TA Q.TY	CODICE CODE	A / H	L / W	P / D	DESCRIZIONE / DESCRIPTION
1	BF35	165,0	50,0	2,5	Boiserie SPAZIO5 / SPAZIO5 wall panels
1	BF44	133,0	100,0	2,5	Boiserie SPAZIO5 / SPAZIO5 wall panels
2	BF46	197,0	100,0	2,5	Boiserie SPAZIO5 / SPAZIO5 wall panels
1	BF71	136,4	100,0	213,0	Letto singolo superiore con trafilata scorrevole su guida con carrello / Upper single bed with profiles, sliding rail and truck
1	BF72	32,2	100,0	200,0	Letto singolo inferiore con trafilata scorrevole su guida con carrello / Lower single bed with profiles, sliding rail and truck
1	CSL25	34,0	52,3	43,7	Comodino con ruote e 2 cassetti / Night table on castors with 2 drawers
2	GS83	4,0	150,0	2,1	Guida di scorrimento in alluminio / Sliding rail in aluminium
1	GS85	4,0	250,0	2,1	Guida di scorrimento in alluminio / Sliding rail in aluminium
1	KR83	35,5	100,0	5,0	CITY SCAPE "NEW YORK" / CITY SCAPE "NEW YORK"
1	LC70	132,9	120,8	2,5	Protezione in metallo per scala LCX7 / Metal protection for stair LCX7
1	LCX7	76,0	43,0	120,8	Scala a 3 gradini con ribalta e 2 cassetti per soppalco H.109.2 cm / 3-steps stair with tilt door and 2 drawers for mezzanine H.109.2 cm
1	MGT54	164,6	50,0	2,5	Maggiorazione foratura per guide su 1 pannello boiserie verticale / Supplement for rails drilling on 1 vertical wall panel
1	MGT54	132,6	100,0	2,5	Maggiorazione foratura per guide su 1 pannello boiserie verticale / Supplement for rails drilling on 1 vertical wall panel
2	MGT54	196,6	100,0	2,5	Maggiorazione foratura per guide su 1 pannello boiserie verticale / Supplement for rails drilling on 1 vertical wall panel
1	MGT56	164,6	50,0	2,5	Maggiorazione per coppia di livellatori / Supplement for couple of level adjusters
1	MGT56	132,6	100,0	2,5	Maggiorazione per coppia di livellatori / Supplement for couple of level adjusters
2	MGT56	196,6	100,0	2,5	Maggiorazione per coppia di livellatori / Supplement for couple of level adjusters
2	MP97	22,0	100,0	56,5	Pedana con cassetto / Base with drawer
1	PR31	50,0	100,0	2,0	Protezione in metallo per soppalco / Metal protection for mezzanine
8	PX06A	3,5	3,5	0,2	Maniglia ad incasso circolare con fondo bianco e bordo alluminio / Recessed circular handle with white back and aluminium edge
1	SE72	90,5	65,0	65,0	Sedia con ruote e regolabile in altezza con scocca in legno e basamento in metallo / Chair on castors adjustable in height with wooden structure and metal base
1	SE79	90,5	65,0	65,0	Seduta imbottita sfoderabile per SE72 e SE76 / Upholstered and removable seat for SE72 and SE76
1	TE08	50,0	98,0	10,0	Testata imbottita sfoderabile / Upholstered and removable headboard
1	TF49	100,0	59,0	226,0	Piano fisso ad uso calpestio / Fixed top for walking
1	TQ58	77,2	150,0	65,0	Scrivania spessore 4 cm scorrevole su guida / Sliding desk thickness 4 cm on rail
3	VS24	20,0	43,5	20,5	Mensola T-BOX L 43.5 cm / T-BOX shelf W 43.5 cm
1	VS25	20,0	56,5	20,5	Mensola T-BOX L 56.5 cm / T-BOX shelf W 56.5 cm
1	VS26	20,0	100,0	20,5	Mensola T-BOX L 100 cm / T-BOX shelf W 100 cm

INGOMBRI / DIMENSIONS

CONFIGURATION
320

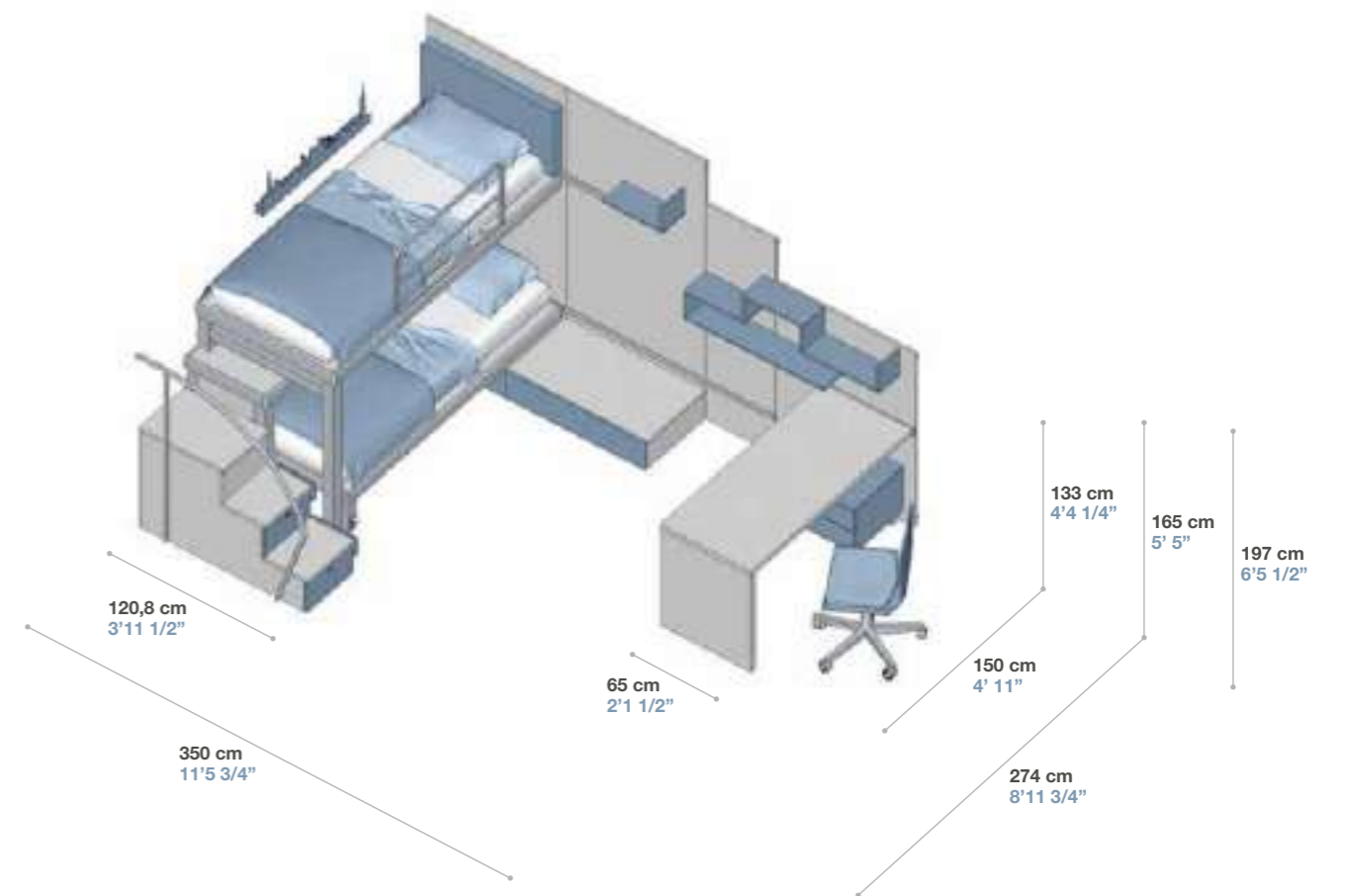

FINITURE / FINISHES

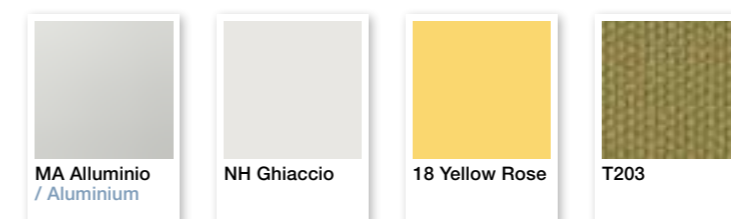

CONFIGURATION
321





DESCRIZIONE TECNICA / TECHNICAL DATA

Q.TA Q.TY	CODICE CODE	A / H	L / W	P / D	DESCRIZIONE / DESCRIPTION
1	AR08	261,0	2,8	56,8	Fianco di chiusura / Closing Side
1	AR08	261,0	2,8	60,5	Fianco di chiusura / Closing Side
1	AR35D1	263,0	173,7	56,8	Armadio 2 ante scorrevoli e stampa digitale in 1 anta / Wardrobe 2 sliding doors and digital print in 1 door
1	CSL33	50,0	37,5	43,7	Comodino con ruote con 3 cassetti / Night table on castors with 3 drawers
1	E182	39,4	166,6	33,4	Libreria a due mensole per composizione 321 / 2-shelves bookcase for composition 321
1	E183	210,2	200,0	33,4	Libreria a 3 mensole, anta scorrevole e piano scrittoio trafila per composizione 321 / Bookcase with 3 shelves, sliding door and desk with profiles with composition 321
7	EZ21	1,4	1,4	14,5	Reggimensola a scomparsa con foratura / Concealed bracket for shelf with drilling
1	LB41	102,0	100,0	213,0	Letto COMFORT singolo con trafila e testata imbottita H.70 cm / COMFORT single bed with profiles and upholstered headboard H.70 cm
1	MG87	76,0	99,0	2,0	Anta scorrevole per doppio vano con guida / Sliding door for 2-sections with rail
1	SE72	90,5	65,0	65,0	Sedia con ruote e regolabile in altezza con scocca in legno e basamento in metallo / Chair on castors adjustable in height with wooden structure and metal base
1	SE79	90,5	65,0	65,0	Seduta imbottita sfoderabile per SE72 e SE76 / Upholstered and removable seat for SE72 and SE76
1	TF20	76,2	133,4	59,0	Scrittoio con piano trafila scorrevole su piano trafila / Sliding desk on top with profiles
1	UV99	100,0	231,8	0,1	Stampa digitale su pannello con immagine archivio Tumidei o cliente / Digital print on panel with image from Tumidei' library or from customer
1	UV99	100,0	100,0	0,1	Stampa digitale su pannello con immagine archivio Tumidei o cliente / Digital print on panel with image from Tumidei' library or from customer

INGOMBRI / DIMENSIONS

CONFIGURATION

321

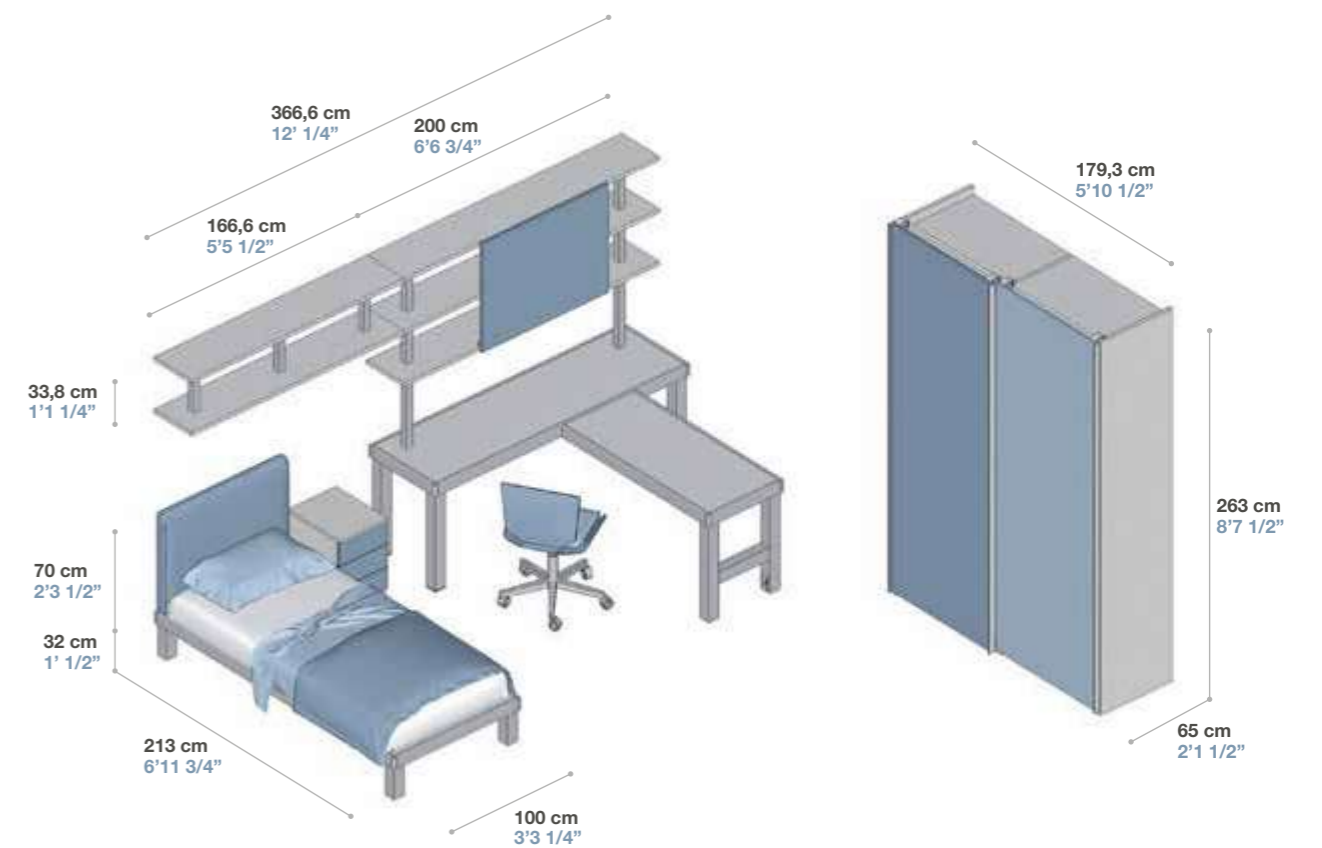

FINITURE / FINISHES

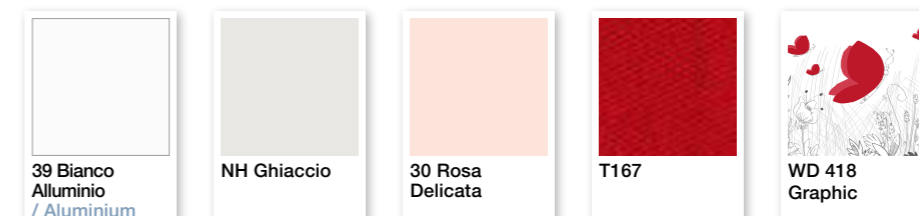

CONFIGURATION
322





DESCRIZIONE TECNICA / TECHNICAL DATA

Q.TA Q.TY	CODICE CODE	A / H	L / W	P / D	DESCRIZIONE / DESCRIPTION
1	B146	261,0	85,6	56,8	Colonna armadio 2 ante / Column wardrobe 2 doors
1	BF59	145,2	100,0	226,0	Letto superiore scorrevole su guida / Upper sliding bed on rail
2	FN48	261,0	3,2	59,0	Fianco SYSTEM 32 / SYSTEM 32 Side
1	GSV34	7,3	206,0	4,0	Guida di scorrimento DRIVE in alluminio / DRIVE sliding rail in aluminium
1	GSV34	7,3	242,0	4,0	Guida di scorrimento DRIVE in alluminio / DRIVE sliding rail in aluminium
1	LB61	32,0	100,0	200,0	Letto singolo con trafila scorrevole su ruote unidirezionali / Single bed with sliding profiles and one-way castors
1	LCX5	101,0	43,0	182,6	Scala a 4 gradini con 3 cassetti e 3 vani a giorno per soppalco H.109.2 cm e H.141.2 cm / 4-steps stair with 3 drawers and 3 open sections for mezzanine H.109.2 and H.141.2 cm
1	LCY3	102,0	2,0	124,0	Pannello laterale per scala / Side panel for stair
1	MP97	22,0	100,0	56,5	Pedana con cassetto / Base with drawer
1	P933	261,0	252,0	59,0	Ponti SPAZIO 5 per letto scorrevole superiore con 2 ante battenti / SPAZIO 5 bridges for upper sliding bed with 2 hinged doors
2	PM66	0,8	20,0	4,0	Maniglia Side H. 200 / Side handle H. 200
1	PM67	110,0	0,8	4,0	Maniglia Side H. 1100 / Side handle H. 1100
1	PR31	50,0	100,0	2,0	Protezione in metallo per soppalco / Metal protection for mezzanine
3	PX06B	3,5	3,5	0,2	Maniglia ad incasso circolare con fondo e bordo bianchi / Recessed circular handle with white back and edge
1	SE72	90,5	65,0	65,0	Sedia con ruote e regolabile in altezza con scocca in legno e basamento in metallo / Chair on castors adjustable in height with wooden structure and metal base
1	SE79	90,5	65,0	65,0	Seduta imbottita sfoderabile per SE72 e SE76 / Upholstered and removable seat for SE72 and SE76
1	TE08	50,0	98,0	10,0	Testata imbottita sfoderabile / Upholstered and removable headboard
1	TF44	76,2	213,0	65,0	Scrivania con piano trafila scorrevole su guida / Desk with profiles sliding on rail

INGOMBRI / DIMENSIONS

CONFIGURATION
322

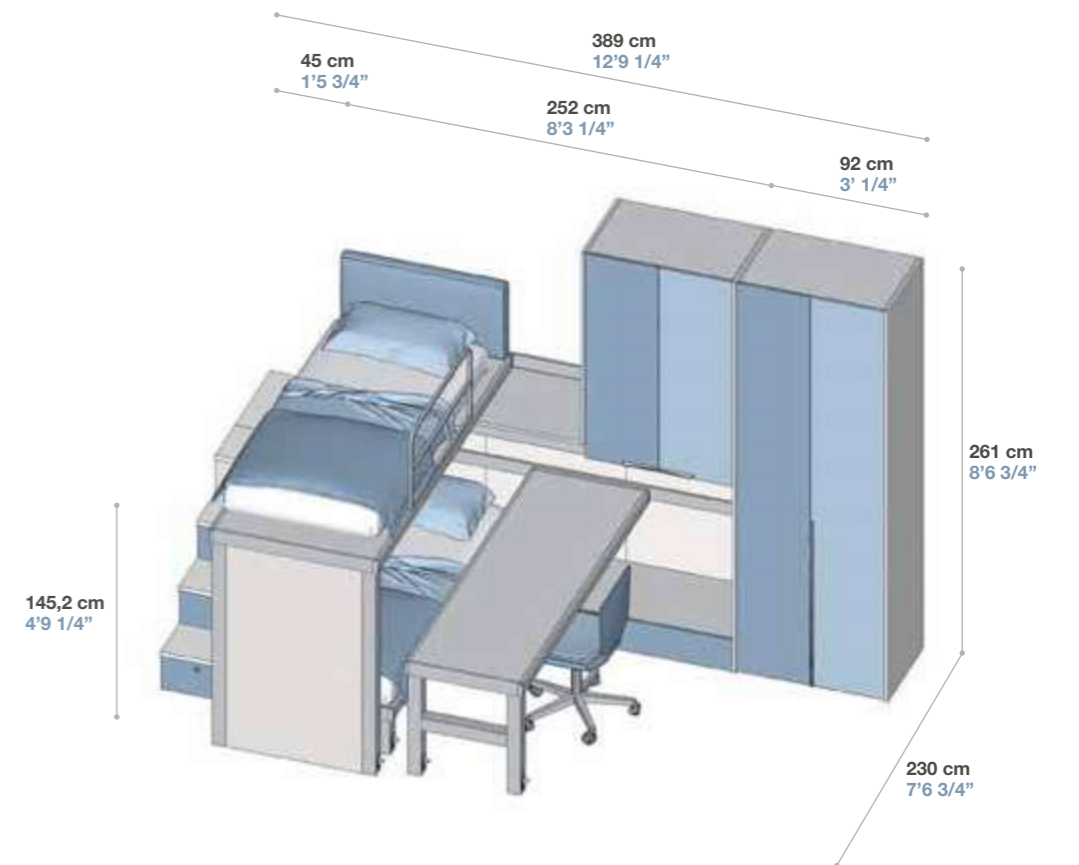

FINITURE / FINISHES

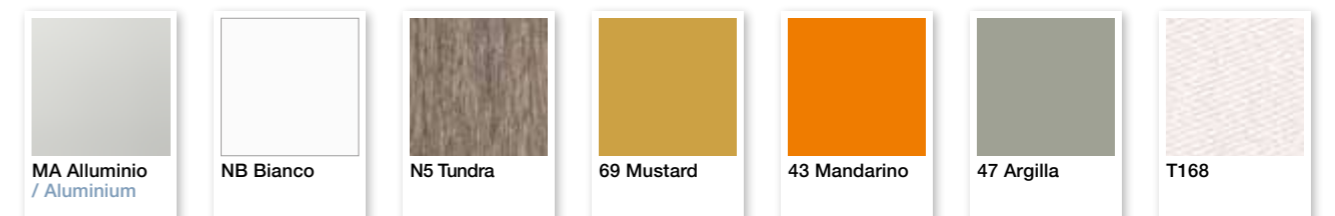



#COOL KIDS

LETTI SCORREVOLI CON TRAFILA

Sliding beds with profiles







DESCRIZIONE TECNICA / TECHNICAL DATA

Q.TA Q.TY	CODICE CODE	A / H	L / W	P / D	DESCRIZIONE / DESCRIPTION
2	AR08	261,0	2,8	56,8	Fianco di chiusura / Closing Side
1	AR36	263,0	261,8	56,8	Armadio 3 ante scorrevoli / Wardrobe 3 sliding doors
4	BF46	197,0	100,0	2,5	Boiserie SPAZIO5 / SPAZIO5 wall panels
1	BF73	66,2	100,0	213,0	Letto singolo intermedio con trafilata scorrevole su guida con carrello / Intermediate single bed with profiles, sliding rail and truck
1	BF76	110,2	100,0	226,0	Letto singolo superiore con trafilata scorrevole su guida con carrello / Upper single bed with profiles, sliding rail and truck
2	GSV37	7,3	400,0	4,0	Guida di scorrimento DRIVE in alluminio / DRIVE sliding rail in aluminium
1	LB61	32,0	100,0	200,0	Letto singolo con trafilata scorrevole su ruote unidirezionali / Single bed with sliding profiles and one-way castors
2	ME35	2,8	200,0	33,4	Mensola lineare con reggimensola a scomparsa / Linear shelf with concealed bracket
4	MGT54	196,6	100,0	2,5	Maggiorazione foratura per guide su 1 pannello boiserie verticale / Supplement for rails drilling on 1 vertical wall panel
4	MGT56	196,6	100,0	2,5	Maggiorazione per coppia di livellatori / Supplement for couple of level adjusters
3	MP97	22,0	100,0	56,5	Pedana con cassetto / Base with drawer
3	PX09	5,2	19,4	0,2	Maniglia ad incasso rettangolare con presa / Recessed rectangular handle with grip
1	UV99	100,0	789,6	0,1	Stampa digitale su pannello con immagine archivio Tumidei o cliente / Digital print on panel with image from Tumidei' library or from customer

INGOMBRI / DIMENSIONS

CONFIGURATION
323

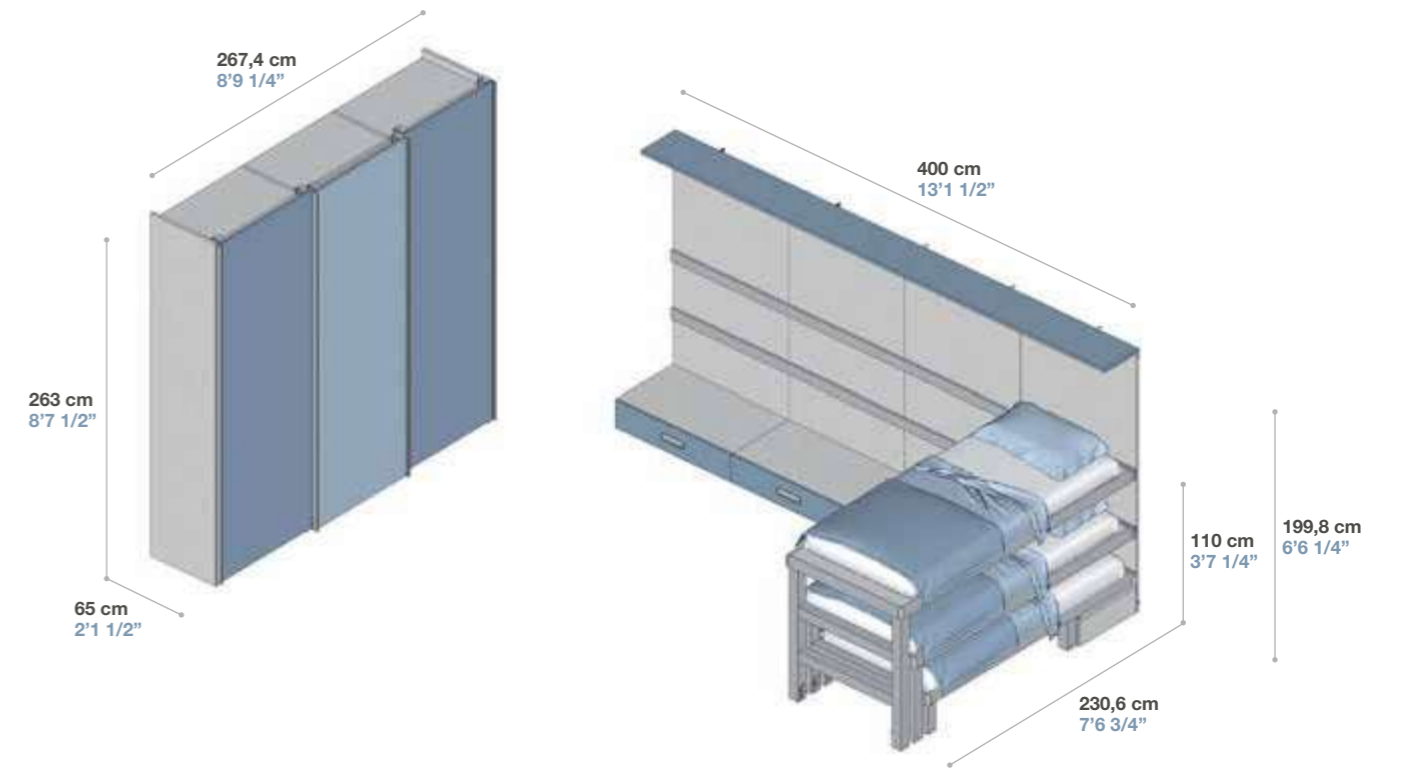

FINITURE / FINISHES

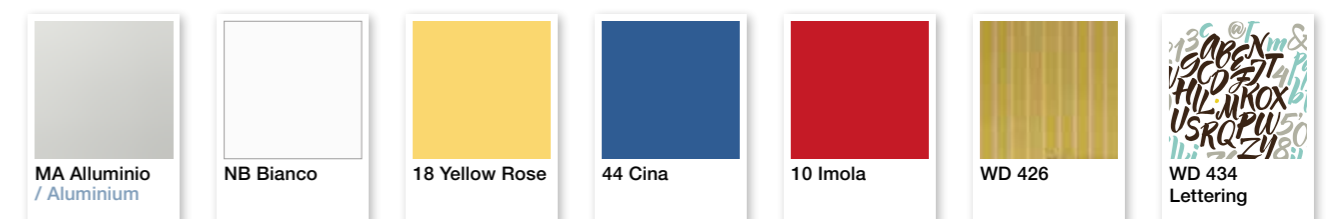





DESCRIZIONE TECNICA / TECHNICAL DATA

Q.TA Q.TY	CODICE CODE	A / H	L / W	P / D	DESCRIZIONE / DESCRIPTION
1	BF36	197,0	50,0	2,5	Boiserie SPAZIO5 / SPAZIO5 wall panels
2	BF46	197,0	100,0	2,5	Boiserie SPAZIO5 / SPAZIO5 wall panels
1	BF73	66,2	100,0	213,0	Letto singolo intermedio con trafilata scorrevole su guida con carrello / Intermediate single bed with profiles, sliding rail and truck
1	GSV32	7,3	150,0	4,0	Guida di scorrimento DRIVE in alluminio / DRIVE sliding rail in aluminium
1	GSV34	7,3	250,0	4,0	Guida di scorrimento DRIVE in alluminio / DRIVE sliding rail in aluminium
1	LB61	32,0	100,0	200,0	Letto singolo con trafilata scorrevole su ruote unidirezionali / Single bed with sliding profiles and one-way castors
1	MGT54	196,6	50,0	2,5	Maggiorazione foratura per guide su 1 pannello boiserie verticale / Supplement for rails drilling on 1 vertical wall panel
2	MGT54	196,6	100,0	2,5	Maggiorazione foratura per guide su 1 pannello boiserie verticale / Supplement for rails drilling on 1 vertical wall panel
1	MGT56	196,6	50,0	2,5	Maggiorazione per coppia di livellatori / Supplement for couple of level adjusters
2	MGT56	196,6	100,0	2,5	Maggiorazione per coppia di livellatori / Supplement for couple of level adjusters
1	MP96	22,0	50,0	56,5	Pedana con cassetto / Base with drawer
2	MP97	22,0	100,0	56,5	Pedana con cassetto / Base with drawer
1	MQA85	66,3	82,3	31,1	Elemento multivano pensile con 3 vani a giorno e 1 anta / Wall multi-sections cabinet with 3 open sections and 1 door
1	MQA86	66,3	82,3	31,1	Elemento multivano pensile con 3 vani a giorno e 1 anta / Wall multi-sections cabinet with 3 open sections and 1 door
1	MQA98	66,3	82,3	31,1	Elemento multivano pensile con 2 vani a giorno e 1 anta intera / Wall multi-sections cabinet with 2 open sections and 1 full door
1	MQB02	82,3	66,3	31,1	Elemento multivano pensile con 2 vani a giorno e 1 anta intera / Wall multi-sections cabinet with 2 open sections and 1 full door
2	PUF4	46,0	40,0	40,0	Pouf con ruote / Pouf with castors
1	TF44	76,2	213,0	65,0	Scrivania con piano trafilata scorrevole su guida / Desk with profiles sliding on rail

INGOMBRI / DIMENSIONS

CONFIGURATION

324

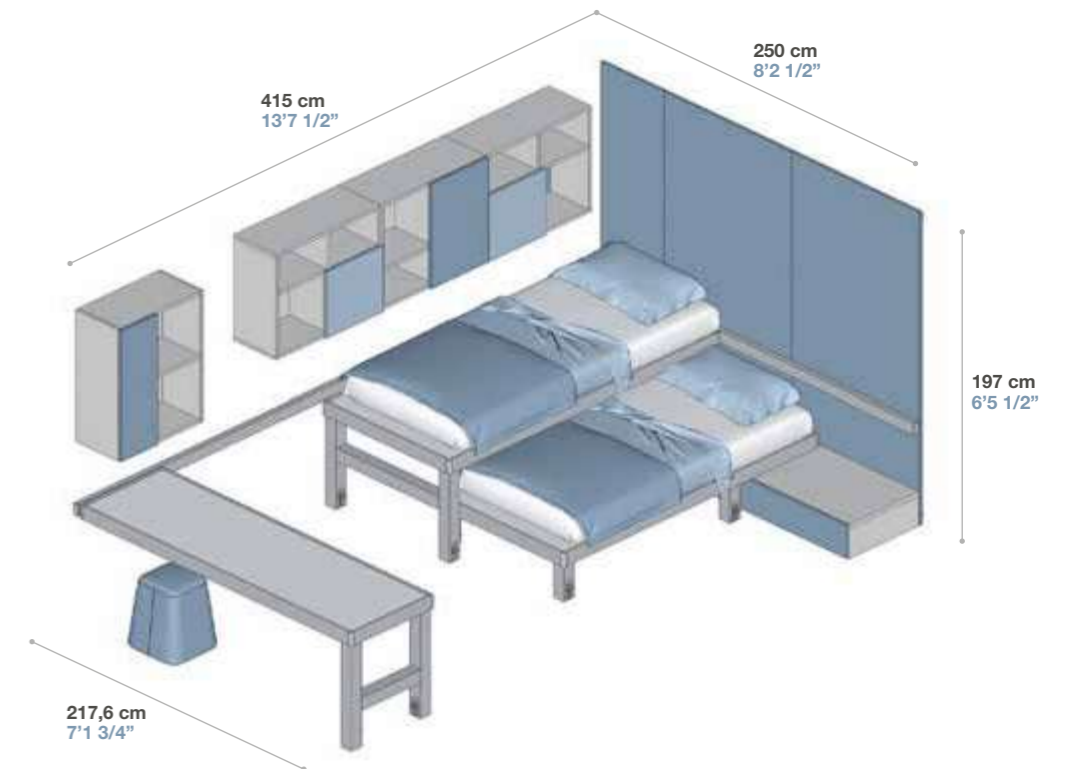

FINITURE / FINISHES

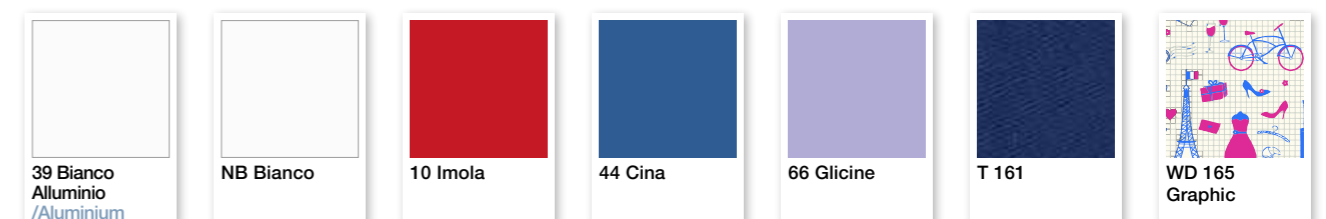

CONFIGURATION
325





DESCRIZIONE TECNICA / TECHNICAL DATA

Q.TA Q.TY	CODICE CODE	A / H	L / W	P / D	DESCRIZIONE / DESCRIPTION
1	BF37	229,0	50,0	2,5	Boiserie SPAZIO5 / SPAZIO5 wall panels
4	BF47	229,0	100,0	2,5	Boiserie SPAZIO5 / SPAZIO5 wall panels
2	BF71	136,2	100,0	213,0	Letto singolo superiore con trafilata scorrevole su guida con carrello / Upper single bed with profiles, sliding rail and truck
2	BF72	32,2	100,0	200,0	Letto singolo inferiore con trafilata scorrevole su guida con carrello / Lower single bed with profiles, sliding rail and truck
1	E186	109,8	100,0	33,4	Libreria composta con sistema a tubo quadro / Composed bookcase with square tube system
6	EZ21	1,4	1,4	14,5	Reggimensola a scomparsa con foratura / Concealed bracket for shelf with drilling
2	GS83	4,0	150,0	2,1	Guida di scorrimento in alluminio / Sliding rail in aluminium
1	GS84	4,0	200,0	2,1	Guida di scorrimento in alluminio / Sliding rail in aluminium
1	GS85	4,0	250,0	2,1	Guida di scorrimento in alluminio / Sliding rail in aluminium
1	MGT54	228,6	50,0	2,5	Maggiorazione foratura per guide su 1 pannello boiserie verticale / Supplement for rails drilling on 1 vertical wall panel
4	MGT54	228,6	100,0	2,5	Maggiorazione foratura per guide su 1 pannello boiserie verticale / Supplement for rails drilling on 1 vertical wall panel
1	MGT56	228,6	50,0	2,5	Maggiorazione per coppia di livellatori / Supplement for couple of level adjusters
4	MGT56	228,6	100,0	2,5	Maggiorazione per coppia di livellatori / Supplement for couple of level adjusters
3	MP97	22,0	100,0	56,5	Pedana con cassetto / Base with drawer
2	PR31	50,0	100,0	2,0	Protezione in metallo per soppalco / Metal protection for mezzanine
1	SCL30	120,2	43,4	40,0	Scala in metallo con aggancio al piano trafilata / Metal stair with connections to aluminium profiles
1	SE72	90,5	65,0	65,0	Sedia con ruote e regolabile in altezza con scocca in legno e basamento in metallo / Chair on castors adjustable in height with wooden structure and metal base
1	SE79	90,5	65,0	65,0	Seduta imbottita sfoderabile per SE72 e SE76 / Upholstered and removable seat for SE72 and SE76
2	TE12	70,0	98,0	10,0	Testata imbottita sfoderabile / Upholstered and removable headboard
1	TF44	76,2	213,0	65,0	Scrivania con piano trafilata scorrevole su guida / Desk with profiles sliding on rail
1	TF49	100,0	59,0	226,0	Piano fisso ad uso calpestio / Fixed top for walking
1	VS01	20,0	74,0	20,5	Mensola T-BOX L 74 cm / T-BOX shelf W 74 cm

INGOMBRI / DIMENSIONS

CONFIGURATION
325

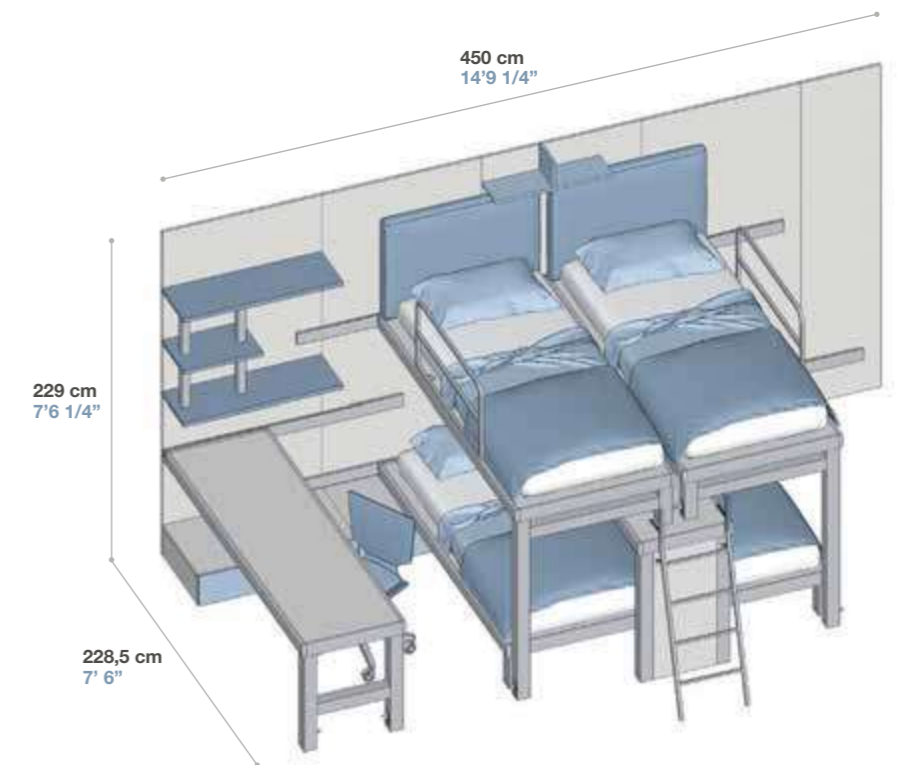

FINITURE / FINISHES

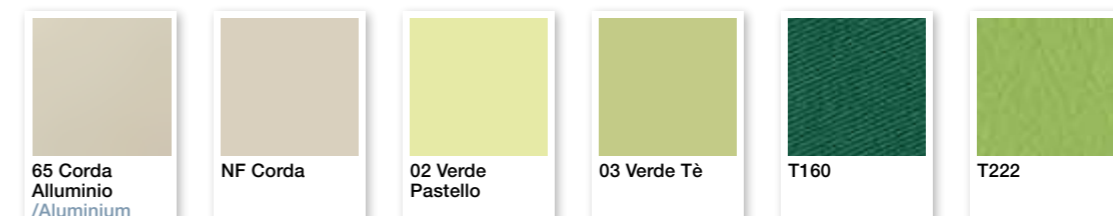

CONFIGURATION
326



DESCRIZIONE TECNICA / TECHNICAL DATA

Q.TA Q.TY	CODICE CODE	A / H	L / W	P / D	DESCRIZIONE / DESCRIPTION
2	AR08	261,0	2,8	56,8	Fianco di chiusura / Closing Side
1	AR36	263,0	261,8	56,8	Armadio 3 ante scorrevoli / Wardrobe 3 sliding doors
5	BF46	197,0	100,0	2,5	Boiserie SPAZIO5 / SPAZIO5 wall panels
1	BF80	110,0	200,0	100,0	Letto singolo superiore con trafilata scorrevole su guida con carrello e con scala e protezioni / Upper single bed with profiles, sliding rail, including truck, stair and protections
1	CSL34	50,0	52,3	43,7	Comodino con ruote e 3 cassetti / Night table on castors with 3 drawers
1	E184	197,0	200,0	33,4	Libreria a tre mensole e piano scrittoio trafilata / Bookcase with 3 shelves and desk with profiles
1	GS86	4,0	300,0	2,1	Guida di scorrimento in alluminio / Sliding rail in aluminium
1	LB31	32,2	100,0	200,0	Letto COMFORT singolo con trafilata senza testata / COMFORT single bed with profiles and no headboard
1	MG87	76,0	99,0	2,0	Anta scorrevole per doppio vano con guida / Sliding door for 2-sections with rail
3	MGT54	196,6	100,0	2,5	Maggiorazione foratura per guide su 1 pannello boiserie verticale / Supplement for rails drilling on 1 vertical wall panel
5	MGT56	196,6	100,0	2,5	Maggiorazione per coppia di livellatori / Supplement for couple of level adjusters
3	ML90	24,0	50,0	25,0	Mensola in metallo con fianchi / Metal shelf with sides
1	PR25	50,7	66,0	3,0	Busta con tasche per testata-protezione PR91 / Envelope with pockets for headboard-protection
1	PR91	53,0	66,0	3,0	Testata-protezione in metallo / Headboard-protection in metal
3	PX08	5,2	5,2	0,2	Maniglia ad incasso rettangolare con presa / Rectangular recessed handle with grip
1	SE76	85,5	65,0	65,0	Sedia con ruote regolabile in altezza con scocca in legno schienale in tessuto e base in metallo / Chair on castors adjustable in height with wooden structure, back in fabric and metal base
1	SE79	85,5	65,0	65,0	Seduta imbottita sfoderabile per SE72 e SE76 / Upholstered and removable seat for SE72 and SE76
1	UV99	100,0	695,5	0,1	Stampa digitale su pannello con immagine archivio Tumidei o cliente / Digital print on panel with image from Tumidei' library or from customer
1	UV99	100,0	100,0	0,1	Stampa digitale su pannello con immagine archivio Tumidei o cliente / Digital print on panel with image from Tumidei' library or from customer

INGOMBRI / DIMENSIONS

CONFIGURATION
326

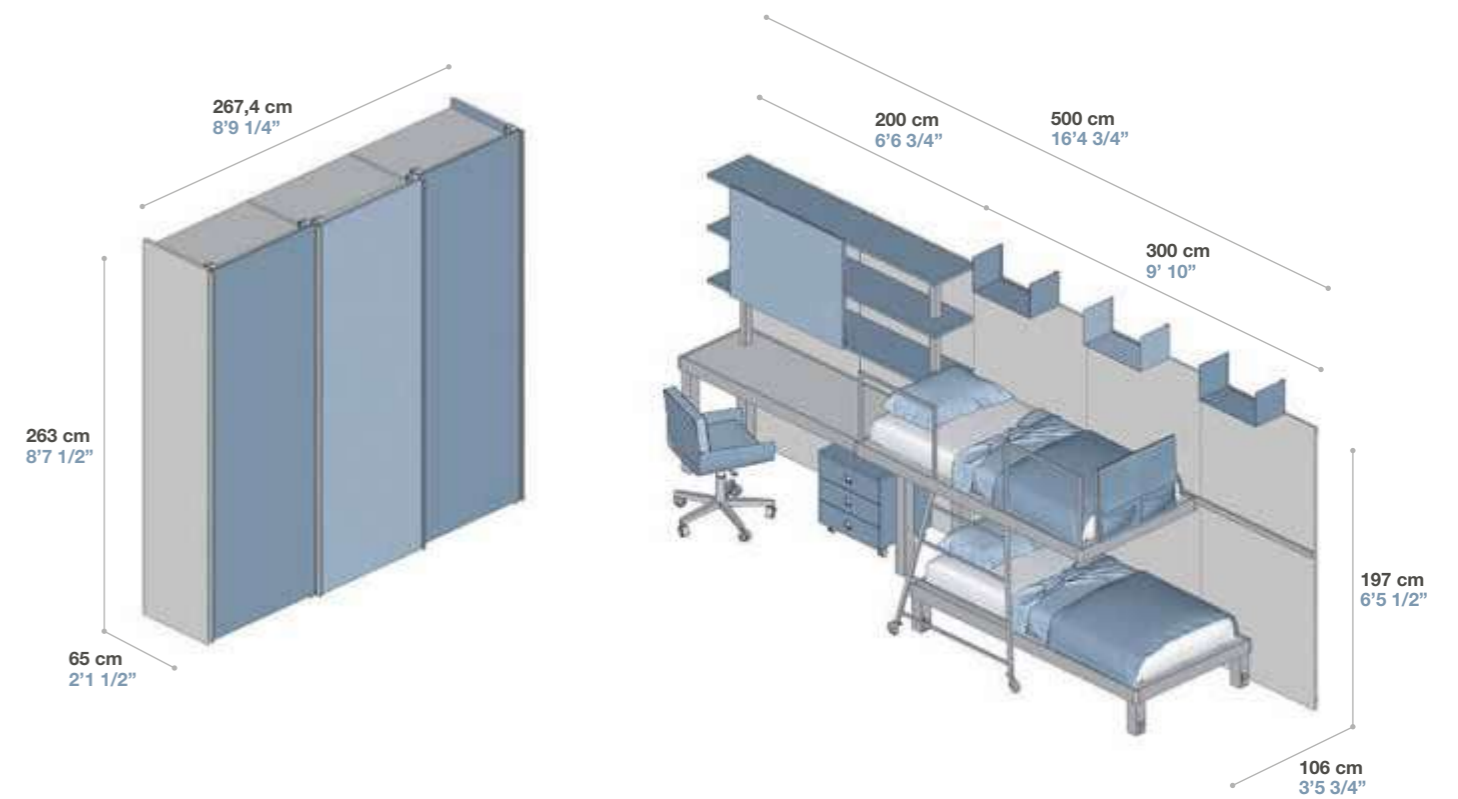

FINITURE / FINISHES

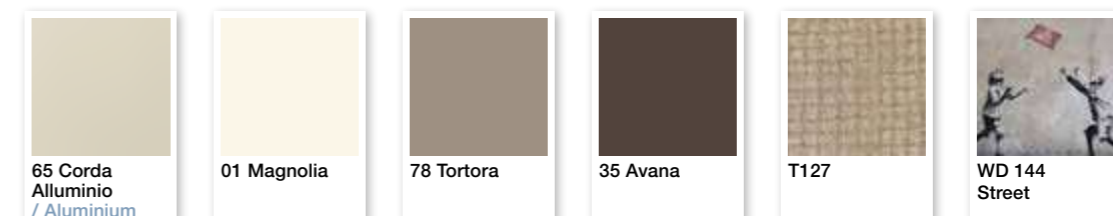

#POWER GIRLS

LETTI SCORREVOLI

Sliding beds



CONFIGURATION
327





Una libreria che divide la zona notte dalla zona lavoro, letti scorrevoli indipendenti che facilitano il riassetto delle camere al mattino ed un capiente armadio a due ante scorrevoli con una stampa digitale della nostra collezione.

A bookcase that divides the night area from the work area, independent sliding beds that facilitate tidying up the room in the morning, and a spacious sliding doors wardrobe with digital print from our collection.



DESCRIZIONE TECNICA / TECHNICAL DATA

Q.TA Q.TY	CODICE CODE	A / H	L / W	P / D	DESCRIZIONE / DESCRIPTION
1	AR07	229,0	2,8	56,8	Fianco finale / End Side
1	AR07	229,0	2,8	60,5	Fianco di chiusura / Closing Side
1	AR31	231,0	173,7	56,8	Armadio 2 ante scorrevoli / Wardrobe 2 sliding doors
2	BF44	133,0	100,0	2,5	Boiserie SPAZIO5 / SPAZIO5 wall panels
1	FF35	165,0	2,8	33,4	Fianco SYSTEM 28 / SYSTEM 28 Side
2	GS84	4,0	200,0	2,1	Guida di scorrimento in alluminio / Sliding rail in aluminium
1	LR33	86,8	96,6	213,6	Letto BIG singolo superiore scorrevole su guida con rete a doghe / Upper single BIG bed with sliding rail and slats
1	LR34	53,2	96,6	202,6	Letto BIG singolo inferiore scorrevole su guida con rete a doghe / Lower single BIG bed with sliding rail and slats
1	MGT32	73,2	4,0	58,6	Maggiorazione taglio fianco in profondità / Supplement for side cut in depth
2	MGT54	132,6	100,0	2,5	Maggiorazione foratura per guide su 1 pannello boiserie verticale / Supplement for rails drilling on 1 vertical wall panel
2	MGT56	132,6	100,0	2,5	Maggiorazione per coppia di livellatori / Supplement for couple of level adjusters
1	ML90	24,0	50,0	25,0	Mensola in metallo con fianchi / Metal shelf with sides
1	ML91	24,0	100,0	25,0	Mensola in metallo con fianchi / Metal shelf with sides
2	MP97	22,0	100,0	56,5	Pedana con cassetto / Base with drawer
1	MY04	4,0	58,8	166,6	Piano sagomato o lineare senza supporti laterali / Shaped or linear top
4	PX06A	3,5	3,5	0,2	Maniglia ad incasso circolare con fondo bianco e bordo alluminio / Recessed circular handle with white back and aluminium edge
1	SE76	85,5	65,0	65,0	Sedia con ruote regolabile in altezza con scocca in legno schienale in tessuto e base in metallo / Chair on castors adjustable in height with wooden structure, back in fabric and metal base
1	SE79	85,5	65,0	65,0	Seduta imbottita sfoderabile per SE72 e SE76 / Upholstered and removable seat for SE72 and SE76
1	T507	165,0	61,6	33,4	Colonna libreria SYSTEM 28 bifacciale da comp. 327 / SYSTEM 28 double-face bookcase column from comp. 327
1	T508	165,0	61,6	33,4	Colonna libreria SYSTEM 28 bifacciale da comp. 327 / SYSTEM 28 double-face bookcase column from comp. 327
1	T509	165,0	61,6	33,4	Colonna libreria SYSTEM 28 bifacciale da comp. 327 / SYSTEM 28 double-face bookcase column from comp. 327
1	T510	165,0	61,6	33,4	Colonna libreria SYSTEM 28 bifacciale da comp. 327 / SYSTEM 28 double-face bookcase column from comp. 327
1	TN67	73,2	4,0	58,6	Fianco lineare spessore 4 cm / Linear Side thickness 4 cm
1	TS87	1,2	249,6	33,6	Top di finitura / Finishing top
1	UV99	100,0	406,0	0,1	Stampa digitale su pannello con immagine archivio Tumidei o cliente / Digital print on panel with image from Tumidei' library or from customer

INGOMBRI / DIMENSIONS

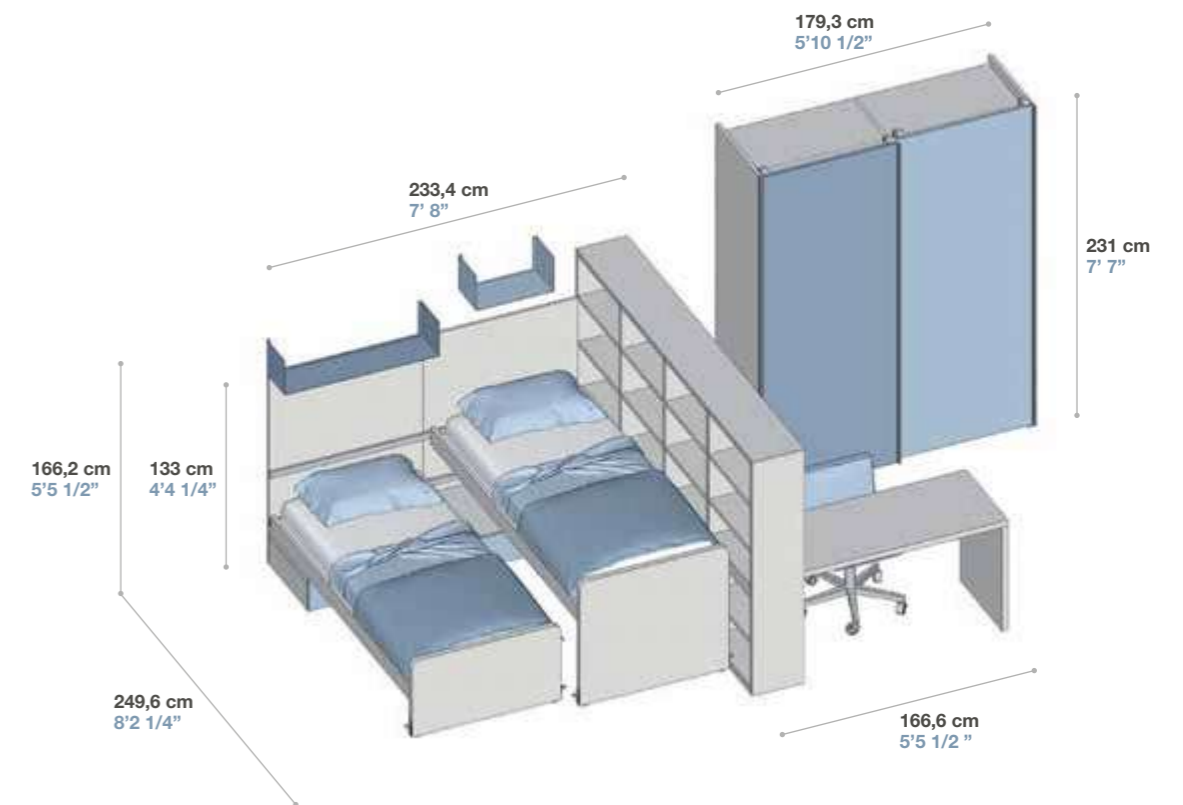
CONFIGURATION
327

FINITURE / FINISHES

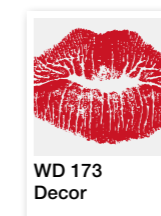



#FUNNY BROTHERS

LETTI SCORREVOLI
Sliding beds







BLUETOOTH SOUND SYSTEM

Nel programma Tiramolla, le casse acustiche, sono inserite nella struttura dello scrittoio. Il sistema Bluetooth ne consente la connessione a tutti i device.

In the Tiramolla program, the speakers are integrated in the profiles. The Bluetooth system allows the connection with all the devices.



DESCRIZIONE TECNICA / TECHNICAL DATA

Q.TA Q.TY	CODICE CODE	A / H	L / W	P / D	DESCRIZIONE / DESCRIPTION
2	B146	261,0	85,6	56,8	Colonna armadio 2 ante / Column wardrobe 2 doors
1	BF33	101,0	50,0	2,5	Boiserie SPAZIO5 / SPAZIO5 wall panels
2	BF43	101,0	100,0	2,5	Boiserie SPAZIO5 / SPAZIO5 wall panels
2	FN08	261,0	2,0	56,8	Fianco SYSTEM 20 / SYSTEM 20 Side
1	FN58	261,0	2,5	56,8	Divisore intermedio / Intermediate Partition
2	GSV34	7,3	250,0	4,0	Guida di scorrimento DRIVE in alluminio / DRIVE sliding rail in aluminium
2	GT63	73,2	8,0	8,0	Tubo quadro 8x8 cm angolare o centrale / Angular or central square tube 8x8
1	IM81	10,0	4,0	0,2	Impianto audio per tubo quadro / Sound system for square tube
1	LR33	86,8	96,6	213,6	Letto BIG singolo superiore scorrevole su guida con rete a doghe / Upper single BIG bed with sliding rail and slats
1	LR34	53,2	96,6	202,6	Letto BIG singolo inferiore scorrevole su guida con rete a doghe / Lower single BIG bed with sliding rail and slats
1	MGT54	100,6	50,0	2,5	Maggiorazione foratura per guide su 1 pannello boiserie verticale / Supplement for rails drilling on 1 vertical wall panel
2	MGT54	100,6	100,0	2,5	Maggiorazione foratura per guide su 1 pannello boiserie verticale / Supplement for rails drilling on 1 vertical wall panel
1	MGT56	100,6	50,0	2,5	Maggiorazione per coppia di livellatori / Supplement for couple of level adjusters
2	MGT56	100,6	100,0	2,5	Maggiorazione per coppia di livellatori / Supplement for couple of level adjusters
1	MP96	22,0	50,0	56,5	Pedana con cassetto / Base with drawer
2	MP97	22,0	100,0	56,5	Pedana con cassetto / Base with drawer
3	MQ55	38,0	40,8	31,1	Elemento pensile verticale con 1 vano a giorno / Vertical wall box with 1 open section
1	MY04	4,0	71,0	167,0	Piano sagomato o lineare senza supporti laterali / Shaped or linear top
2	PM67	110,0	0,8	4,0	Maniglia Side H. 1100 / Side handle H. 1100
1	PZA42	2,8	71,0	33,4	Mensola 2.8 cm per boiserie / Shelf 2.8 cm for wall panels
1	PZA52P	38,0	81,5	46,2	Cassettiera con 2 cassetti premi aperti o maniglia per boiserie / Chest of 2 drawers for wall panels with handle or push-pull opening
2	PZA67A	38,0	81,5	33,4	Contenitore LUDO con 1 ribalta e 2 supporti laterali / LUDO box with 1 tilt door and 2 lateral supports
2	PZA79	8,5	22,3	4,6	Supporto LUDO per aggancio a cremagliera di piani sp. 4 cm / Brackets for connection of tops th. 4 cm onto rack
4	PZA86	194,6	1,6	3,5	Cremagliera regolabile / Adjustable rack
1	PZA92	19,6	71,0	33,4	Mensola sp. 2.8 cm con sponde laterali per boiserie / Shelf th. 2.8 cm with lateral edges for wall panels
2	PZA92	19,6	81,5	33,4	Mensola sp. 2.8 cm con sponde laterali per boiserie / Shelf th. 2.8 cm with lateral edges for wall panels
1	UV99	100,0	100,0	0,1	Stampa digitale su pannello con immagine archivio Tumidei o cliente / Digital print on panel with image from Tumidei' library or from customer

INGOMBRI / DIMENSIONS

CONFIGURATION
328

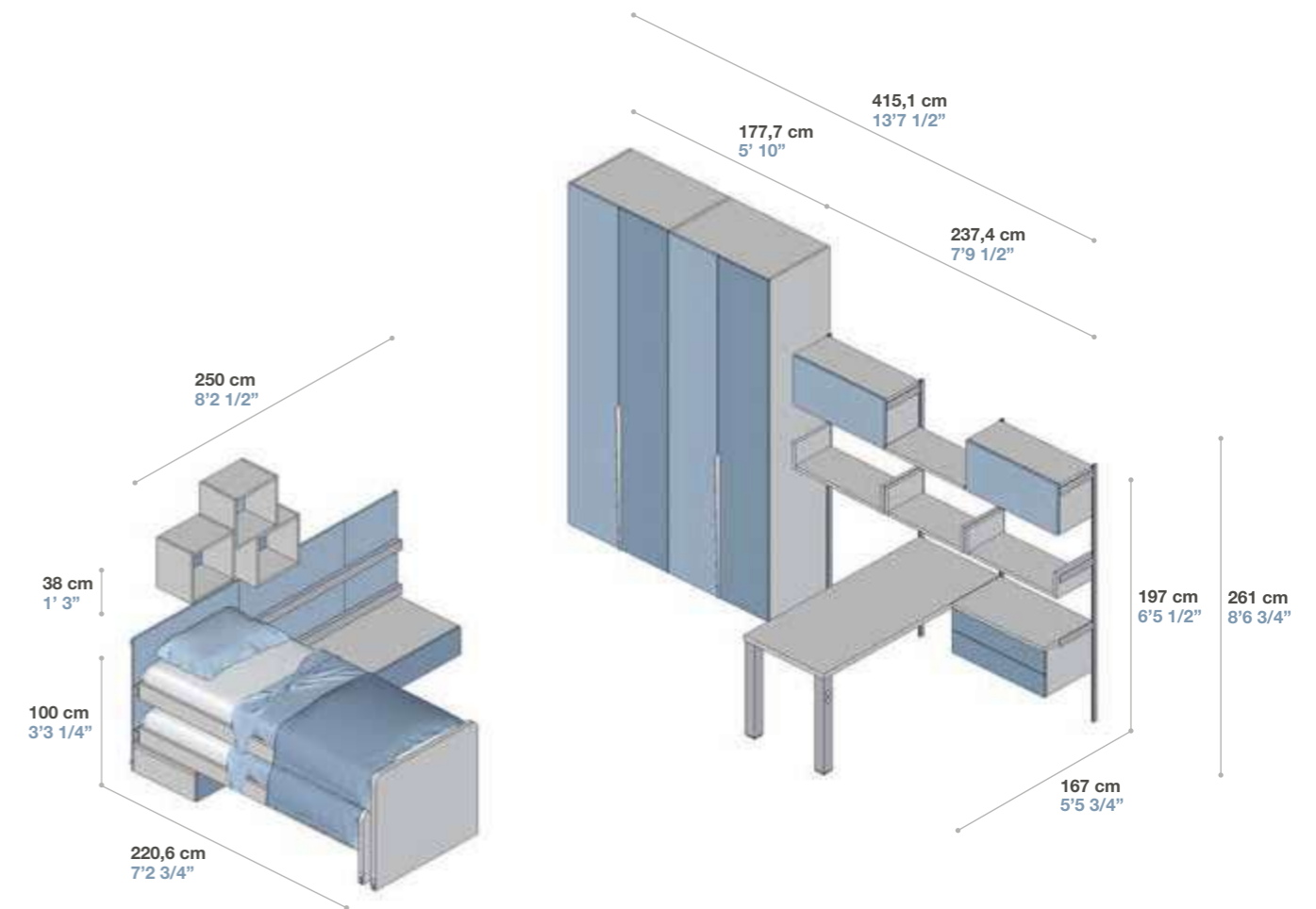

FINITURE / FINISHES



#PLAYFUL KIDS

PONTI CON TRAFILA
Bridges with profiles



Configuration 329



CONFIGURATION
329





Configuration 329



DESCRIZIONE TECNICA / TECHNICAL DATA

Q.TA Q.TY	CODICE CODE	A / H	L / W	P / D	DESCRIZIONE / DESCRIPTION
1	B134	261,0	41,6	56,8	Colonna armadio 1 anta / Column wardrobe 1 door
1	BF73	66,2	100,0	213,0	Letto singolo intermedio con trafilata scorrevole su guida con carrello / Intermediate single bed with profiles, sliding rail and truck
1	FN08	261,0	2,0	56,8	Fianco SYSTEM 20 / SYSTEM 20 Side
1	FN78	261,0	1,2	56,8	Fianco spessore 1,2 cm / Side thickness 1,2 cm
1	GEA06N	261,0	108,1	120,9	Cabina armadio ad angolo tipo B con ante battenti / Corner closet Type B with hinged doors
1	GR23	73,2	4,0	59,0	Gamba telaio in metallo / Frame leg in metal
1	GSV34	7,3	218,0	4,0	Guida di scorrimento DRIVE in alluminio / DRIVE sliding rail in aluminium
1	LB31	32,2	100,0	200,0	Letto COMFORT singolo con trafilata senza testata / COMFORT single bed with profiles and no headboard
1	ME36	2,8	220,0	33,4	Mensola lineare con reggimensola a scomparsa / Linear shelf with concealed bracket
2	MGLAMQ66	40,4	73,6	2,0	Maggiorazione laccatura anta / Supplement for door lacquering
2	MGLMQ5T	36,8	106,0	2,0	Maggiorazione laccatura schiena / Supplement for lacquered back
1	MJB20	4,0	220,0	76,0	Piano sagomato / Shaped desk
1	MQA47	40,8	110,0	31,1	Elemento pensile orizzontale con 3 vani a giorno e 1 anta doppia / Horizontal wall box with 3 open sections and 1 double door
1	MQA48	40,8	110,0	31,1	Elemento pensile orizzontale con 3 vani a giorno e 1 anta doppia / Horizontal wall box with 3 open sections and 1 double door
1	P773N	261,0	220,0	56,8	Ponte lineare SPAZIO 25 con 5 ante battenti / SPAZIO 25 linear bridge with 5 hinged doors
1	P970	261,0	2,0	56,8	Elemento terminale di sostegno in metallo e fianco per elemento pensile H.96 cm / End metal support and side for wall unit H.96 cm
2	PM62	259,1	20,0	2,0	Maniglia Code L. 200 per ante H. 2610 / Code handle W.200 for doors H. 2610
1	PM64	259,1	12,0	2,0	Maniglia Code L. 120 per ante H. 2610 / Code handle W.120 for doors H. 2610
1	SE24	107,5	63,0	63,0	Sedia con ruote e regolabile in altezza con scocca in legno e basamento in metallo / Chair on castors adjustable in height with wooden structure and metal base
3	VS25	20,0	56,5	20,5	Mensola T-BOX L 56.5 cm / T-BOX shelf W 56.5 cm

INGOMBRI / DIMENSIONS

CONFIGURATION
329

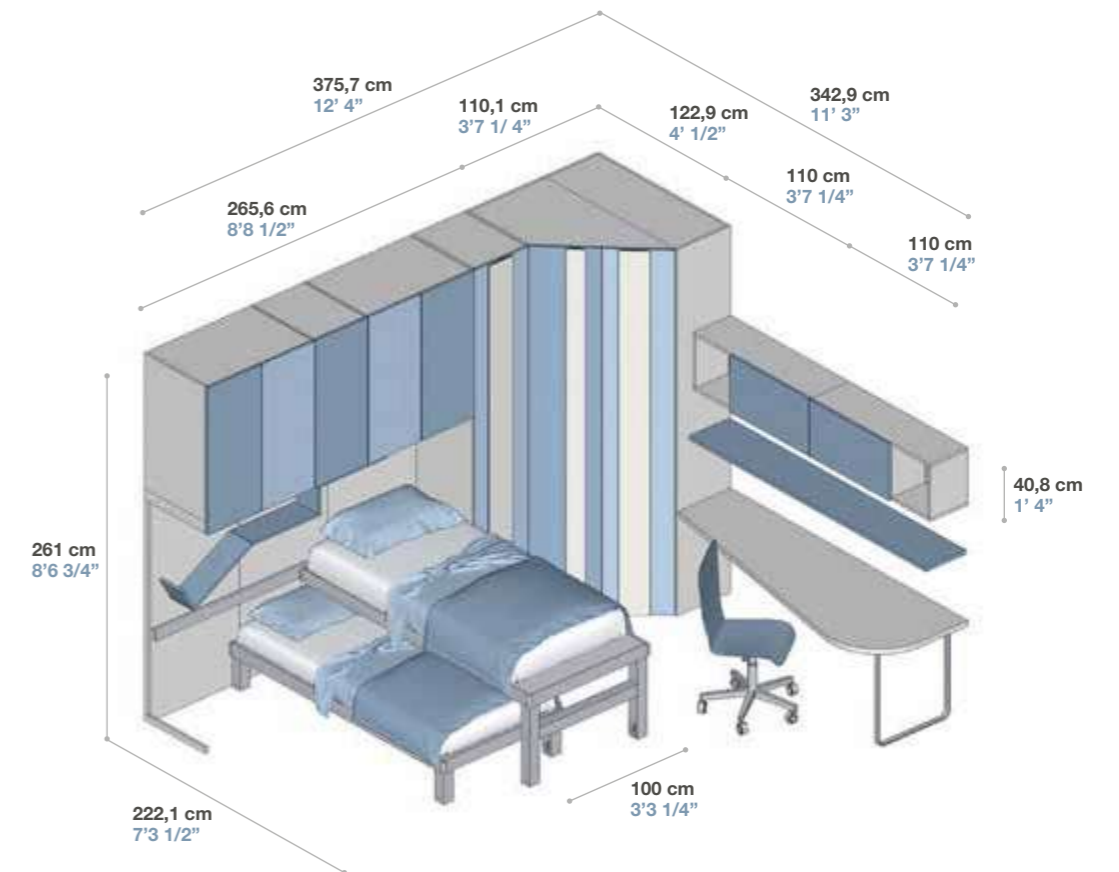

FINITURE / FINISHES

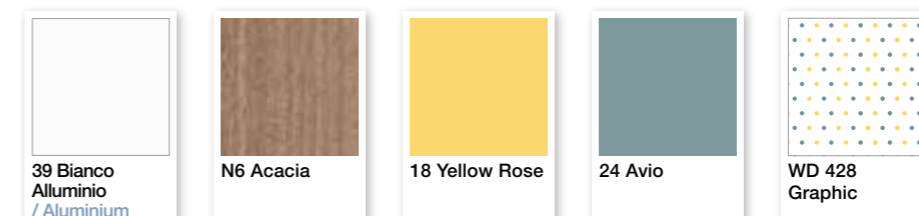

CONFIGURATION
330



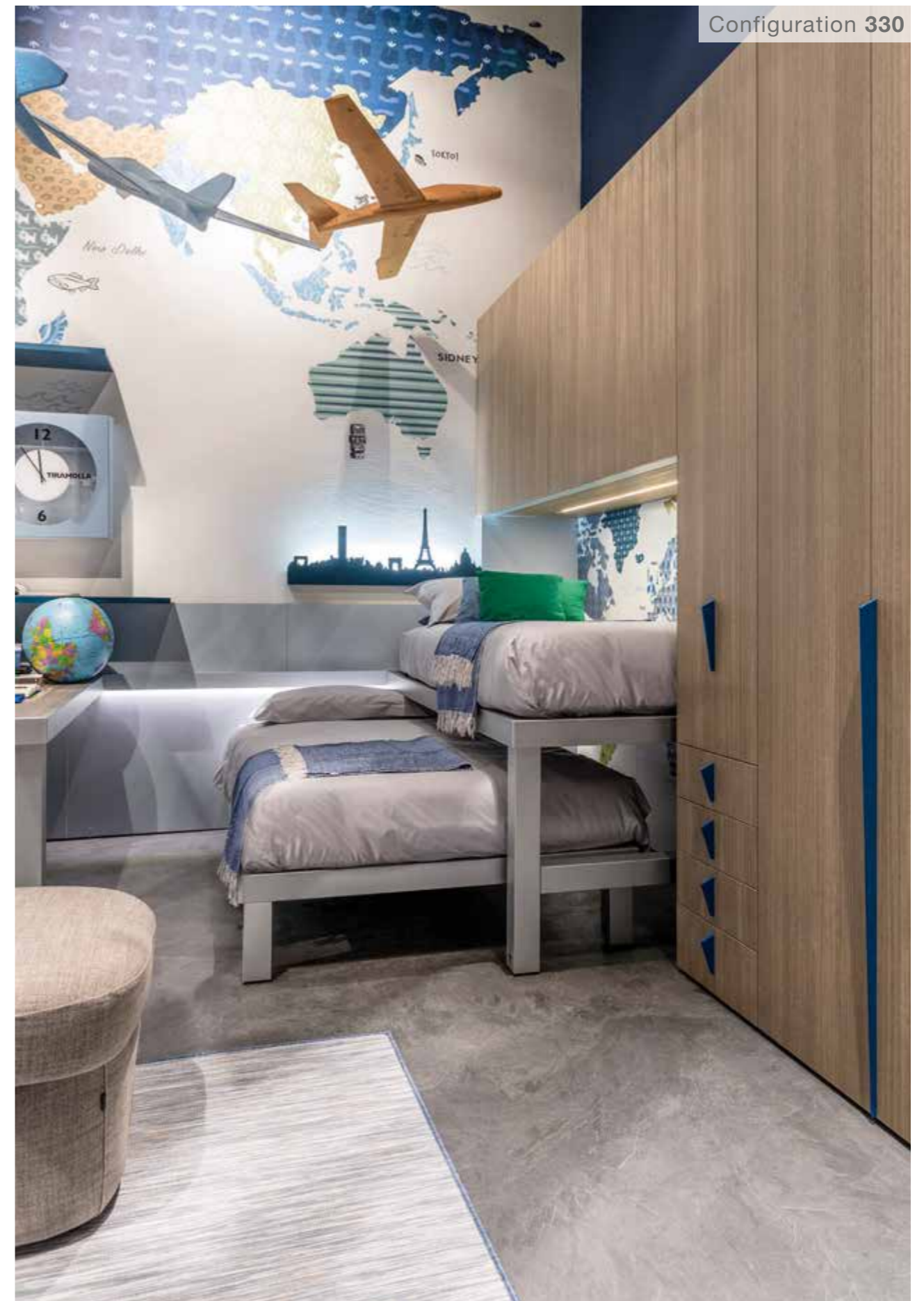



MAGIC MIRROR

Magic Mirror è uno specchio a tutta altezza integrato in un terminale armadio dalla profondità ridotta. Lo specchio può ruotare su se stesso di 180° e svela un pratico porta scarpe oppure dei ganci appendiabiti.

Il Magic Mirror sfrutta tutto lo spazio disponibile, creando una doppia valenza ad un terminale che sorprende per la praticità e la funzionalità.

Magic Mirror is a total height mirror which has been integrated into a wardrobe end unit having reduced depth. The mirror rotates 180 degrees and reveals a practical rack for shoes or coat hanger hooks.

Magic Mirror makes the most of the available space by creating a double value and an end unit which amazes for its convenience and functions.



Configuration 330

DESCRIZIONE TECNICA / TECHNICAL DATA

Q.TA Q.TY	CODICE CODE	A / H	L / W	P / D	DESCRIZIONE / DESCRIPTION
1	B139	261,0	41,6	56,8	Colonna armadio 1 anta e 4 cassetti / Column wardrobe 1 door and 4 drawers
1	B146	261,0	85,6	56,8	Colonna armadio 2 ante / Column wardrobe 2 doors
1	BF37	229,0	50,0	2,5	Boiserie SPAZIO5 / SPAZIO5 wall panels
1	BF44	110,0	54,0	2,5	Boiserie SPAZIO5 / SPAZIO5 wall panels
3	BF44	110,0	100,0	2,5	Boiserie SPAZIO5 / SPAZIO5 wall panels
1	BF45	165,0	56,5	2,5	Boiserie SPAZIO5 / SPAZIO5 wall panels
1	BF47	229,0	100,0	2,0	Boiserie SPAZIO5 / SPAZIO5 wall panels
1	BF76	76,2	100,0	213,0	Letto singolo superiore con trafilata scorrevole su guida con carrello / Upper single bed with profiles, sliding rail and truck
1	CSL33	50,0	37,5	43,7	Comodino con ruote con 3 cassetti / Night table on castors with 3 drawers
1	E190	112,6	200,0	33,4	Libreria a quattro mensole per composizione 330 / 4-shelves bookcase for composition 330
10	EZ21	1,4	1,4	14,5	Reggimensola a scomparsa con foratura / Concealed bracket for shelf with drilling
2	FN08	261,0	2,0	56,8	Fianco SYSTEM 20 / SYSTEM 20 Side
1	FN58	261,0	2,5	56,8	Divisore intermedio / Intermediate Partition
1	GSV37	7,3	400,0	4,0	Guida di scorrimento DRIVE in alluminio / DRIVE sliding rail in aluminium
1	KK28N6	261,0	33,4	59,0	6 Portascarpe / 6 racks for shoes
1	LB63	32,0	125,0	200,0	Letto singolo con trafilata scorrevole su ruote unidirezionali / Single bed with sliding profiles and one-way castors
1	MGT54	109,6	54,0	2,5	Maggiorazione foratura per guide su 1 pannello boiserie verticale / Supplement for rails drilling on 1 vertical wall panel
1	MGT54	164,6	56,5	2,5	Maggiorazione foratura per guide su 1 pannello boiserie verticale / Supplement for rails drilling on 1 vertical wall panel
3	MGT54	109,6	100,0	2,5	Maggiorazione foratura per guide su 1 pannello boiserie verticale / Supplement for rails drilling on 1 vertical wall panel
1	MGT56	109,6	54,0	2,5	Maggiorazione per coppia di livellatori / Supplement for couple of level adjusters
1	MGT56	164,6	56,5	2,5	Maggiorazione per coppia di livellatori / Supplement for couple of level adjusters
3	MGT56	109,6	100,0	2,5	Maggiorazione per coppia di livellatori / Supplement for couple of level adjusters
1	MM58	261,0	33,4	59,0	MAGIC MIRROR elemento terminale con specchio girevole / MAGIC MIRROR end unit with swivel mirror
1	MP65N	56,0	56,0	20,0	Elemento orologio multivano pensile H.56 cm con ripiano in vetro / Wall multi-sections clock H.56 cm with glass shelf
1	MP97	22,0	100,0	56,5	Pedana con cassetto / Base with drawer
1	P963	261,0	226,0	56,8	Ponte lineare SPAZIO 5 con 2 ante complanari / SPAZIO 5 linear bridge with 2 flush sliding doors
1	PA99	2,0	224,0	46,3	Pannello di chiusura sottoponte / Closing panel for under bridge
7	PM65	0,8	11,0	4,0	Maniglia Side H. 110 / Side handle H. 110
1	PM66	0,8	20,0	4,0	Maniglia Side H. 200 / Side handle H. 200
1	PM67	110,0	0,8	4,0	Maniglia Side H. 1100 / Side handle H. 1100
1	PUF11	45,0	60,0	60,0	Pouf VIBE / VIBE pouf
1	PUF11	45,0	60,0	60,0	Pouf VIBE / VIBE pouf
3	PX35L	8,0	8,0	4,7	Pomolo ovale in frassino laccato / Oval knob in lacquered ash
1	SE72	90,5	65,0	65,0	Sedia con ruote e regolabile in altezza con scocca in legno e basamento in metallo / Chair on castors adjustable in height with wooden structure and metal base
1	SE79	90,5	65,0	65,0	Seduta imbottita sfoderabile per SE72 e SE76 / Upholstered and removable seat for SE72 and SE76
2	SV65	149,0	49,9	0,4	Specchio / Mirror
1	TF45	76,2	166,6	65,0	Scrivania con piano trafilata scorrevole su guida / Desk with profiles sliding on rail
1	UV99	100,0	712,2	0,1	Stampa digitale su pannello con immagine archivio Tumidei o cliente / Digital print on panel with image from Tumidei' library or from customer

INGOMBRI / DIMENSIONS

CONFIGURATION
330

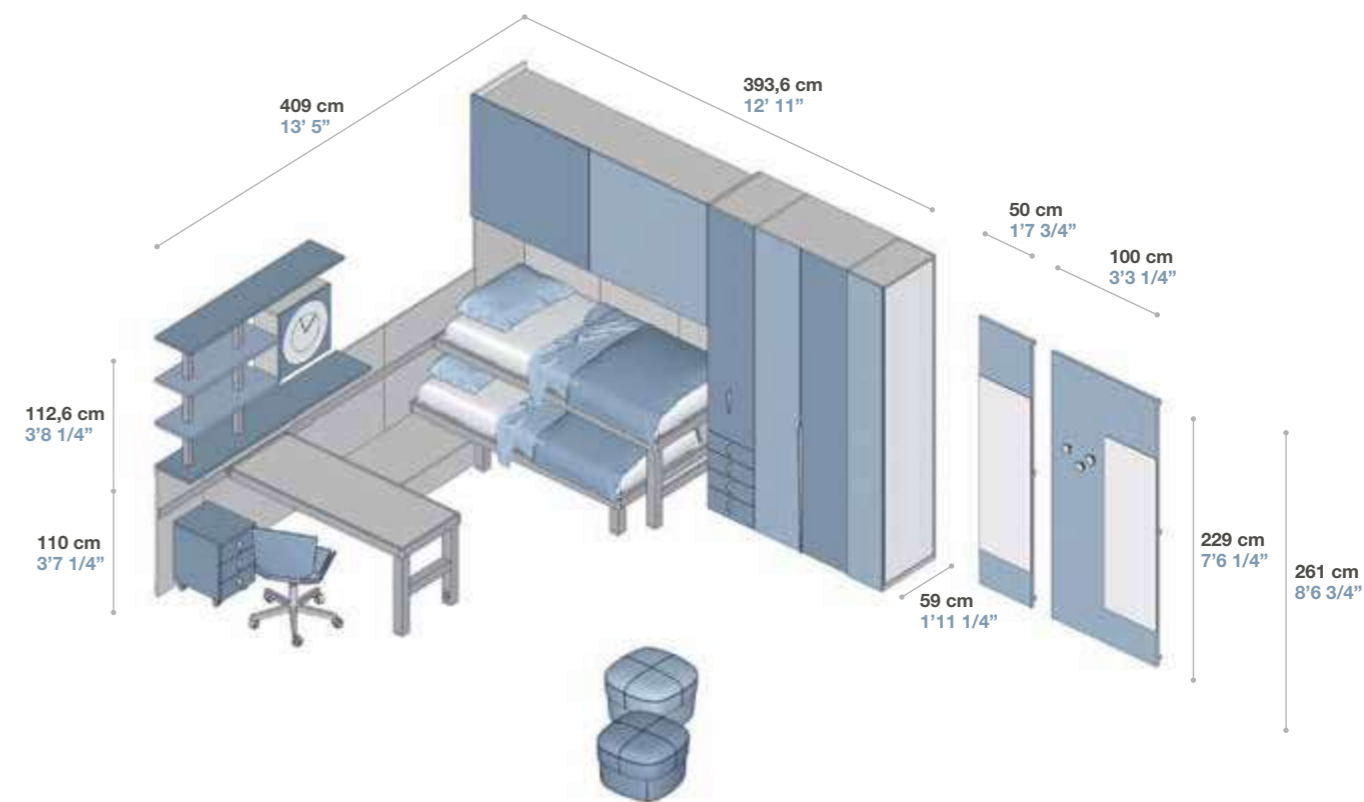

FINITURE / FINISHES





DESCRIZIONE TECNICA / TECHNICAL DATA

Q.TA Q.TY	CODICE CODE	A / H	L / W	P / D	DESCRIZIONE / DESCRIPTION
1	BE55	165,0	50,0	4,5	Boiserie SPAZIO25 / SPAZIO25 wall panels
1	BE65	165,0	100,0	4,5	Boiserie SPAZIO25 / SPAZIO25 wall panels
2	BG35	165,0	2,0	4,5	Profilo di chiusura laterale / Filler strip on side
1	BG41	2,0	52,0	4,5	Profilo di chiusura superiore / Filler strip on top
1	BG42	2,0	102,0	4,5	Profilo di chiusura superiore / Filler strip on top
2	FNM5	164,6	2,0	59,0	Elemento terminale di sostegno per elemento pensile H.96 cm / End element for support of wall unit H.96 cm
2	GS84	4,0	188,0	2,1	Guida di scorrimento in alluminio / Sliding rail in aluminium
1	GS88	4,0	376,0	2,1	Guida di scorrimento in alluminio / Sliding rail in aluminium
2	LR34	53,2	96,6	202,6	Letto BIG singolo inferiore scorrevole su guida con rete a doghe / Lower single BIG bed with sliding rail and slats
1	MGT54	164,6	50,0	4,5	Maggiorazione foratura per guide su 1 pannello boiserie verticale / Supplement for rails drilling on 1 vertical wall panel
1	MGT54	164,6	100,0	4,5	Maggiorazione foratura per guide su 1 pannello boiserie verticale / Supplement for rails drilling on 1 vertical wall panel
1	P782	261,0	226,0	59,0	Ponte lineare SPAZIO 25 con 2 ante scorrevoli / SPAZIO 25 linear bridge with 2 sliding doors
1	PA99	2,0	222,0	46,5	Pannello di chiusura sottoponte / Closing panel for under bridge
2	PM42	1,5	33,8	3,5	Maniglia rettangolare / Rectangular handle
1	SE72	90,5	65,0	65,0	Sedia con ruote e regolabile in altezza con scocca in legno e basamento in metallo / Chair on castors adjustable in height with wooden structure and metal base
1	SE79	6,0	47,0	39,0	Seduta imbottita sfoderabile per SE72 e SE76 / Upholstered and removable seat for SE72 and SE76
1	SE79	90,5	65,0	65,0	Seduta imbottita sfoderabile per SE72 e SE76 / Upholstered and removable seat for SE72 and SE76
1	TC02	130,0	130,0	27,5	Elemento pensile T-CLOUD con 8 vani a giorno / T-CLOUD wall box with 8 open sections
2	TC07	29,4	29,4	1,2	Copri diffusore / Loudspeaker cover
1	TQ63	77,2	210,5	65,0	Scrivania spessore 4 cm scorrevole su guida / Sliding desk thickness 4 cm on rail
1	UV99	100,0	102,7	0,1	Stampa digitale su pannello con immagine archivio Tumidei o cliente / Digital print on panel with image from Tumidei' library or from customer

INGOMBRI / DIMENSIONS

CONFIGURATION

331

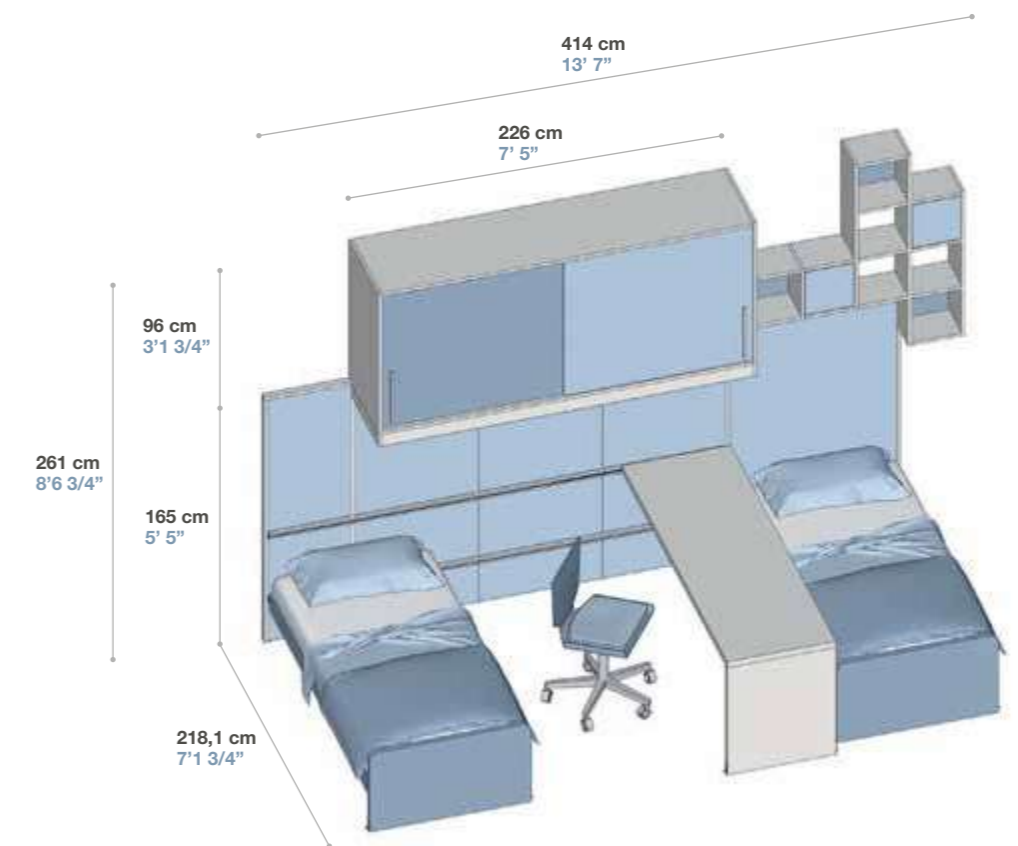

FINITURE / FINISHES







DESCRIZIONE TECNICA / TECHNICAL DATA

Q.TA Q.TY	CODICE CODE	A / H	L / W	P / D	DESCRIZIONE / DESCRIPTION
1	BE65	165,0	100,0	4,5	Boiserie SPAZIO25 / SPAZIO25 wall panels
1	BG35	165,0	2,0	4,5	Profilo di chiusura laterale / Filler strip on side
1	BG42	2,0	102,0	4,5	Profilo di chiusura superiore / Filler strip on top
1	GS85	4,0	231,0	2,1	Guida di scorrimento in alluminio / Sliding rail in aluminium
1	GS87	4,0	335,0	2,1	Guida di scorrimento in alluminio / Sliding rail in aluminium
1	LR33	86,8	96,6	213,6	Letto BIG singolo superiore scorrevole su guida con rete a doghe / Upper single BIG bed with sliding rail and slats
1	LR34	53,2	96,6	202,6	Letto BIG singolo inferiore scorrevole su guida con rete a doghe / Lower single BIG bed with sliding rail and slats
1	MGT54	164,6	100,0	4,5	Maggiorazione foratura per guide su 1 pannello boiserie verticale / Supplement for rails drilling on 1 vertical wall panel
2	MP97	22,0	100,0	56,5	Pedana con cassetto / Base with drawer
1	P781N	261,0	235,0	237,5	Ponte angolare SPAZIO 25 con 8 ante battenti / SPAZIO 25 Corner bridge with 8 hinged doors
2	P970	261,0	2,0	56,8	Elemento terminale di sostegno in metallo e fianco per elemento pensile H.96 cm / End metal support and side for wall unit H.96 cm
4	PX77	5,0	5,0	3,2	Maniglia quadrata / Square handle
1	SE72	90,5	65,0	65,0	Sedia con ruote e regolabile in altezza con scocca in legno e basamento in metallo / Chair on castors adjustable in height with wooden structure and metal base
1	SE79	90,5	65,0	65,0	Seduta imbottita sfoderabile per SE72 e SE76 / Upholstered and removable seat for SE72 and SE76
1	TQ65	77,2	166,6	65,0	Scrivania spessore 4 cm scorrevole su guida per letti / Sliding desk thickness 4 cm on rail
2	VS24	20,0	43,5	20,5	Mensola T-BOX L 43.5 cm / T-BOX shelf W 43.5 cm

INGOMBRI / DIMENSIONS

CONFIGURATION

332

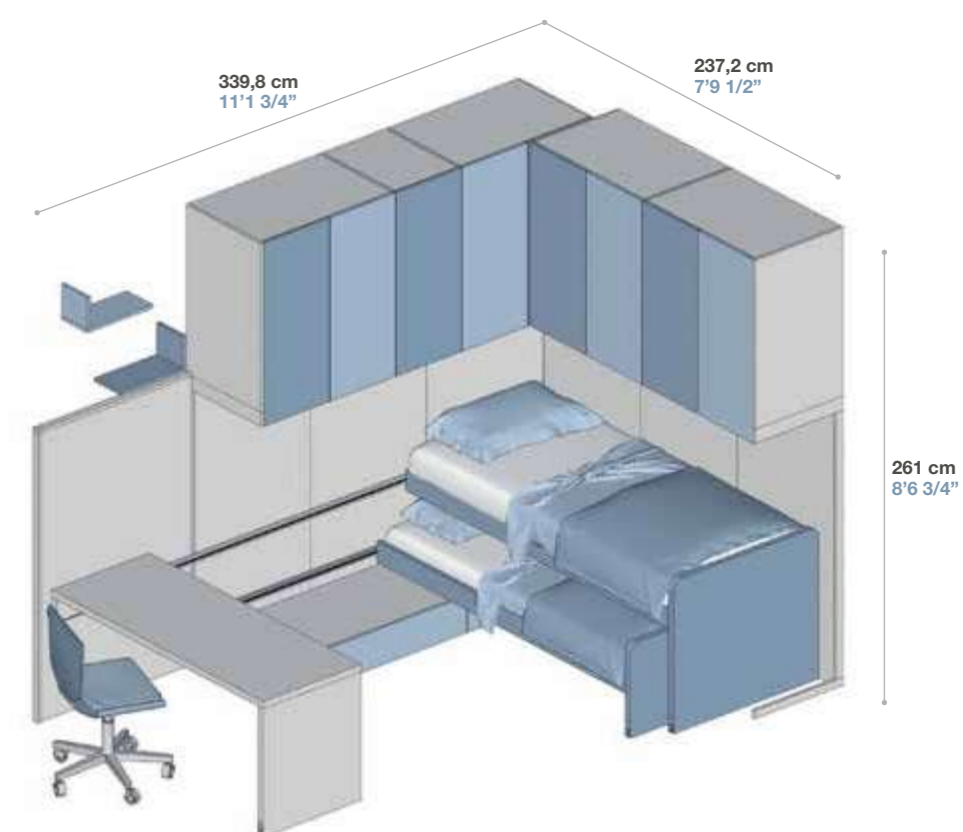

FINITURE / FINISHES

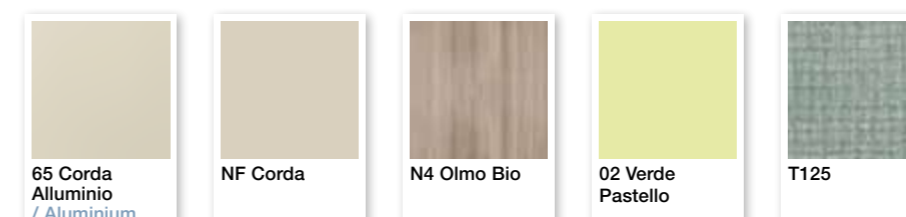

#FREESTYLE GIRL

PONTI CON TRAFILA
Bridges with profiles



Configuration 333

CONFIGURATION
333





DESCRIZIONE TECNICA / TECHNICAL DATA

Q.TA Q.TY	CODICE CODE	A / H	L / W	P / D	DESCRIZIONE / DESCRIPTION
1	B134	261,0	41,6	56,8	Colonna armadio 1 anta / Column wardrobe 1 door
1	FF36	197,0	2,8	33,4	Fianco SYSTEM 28 / SYSTEM 28 Side
1	FN48	261,0	3,2	59,0	Fianco SYSTEM 32 / SYSTEM 32 Side
1	FN58	261,0	2,5	56,8	Divisore intermedio / Intermediate Partition
2	FR63	101,0	2,8	33,4	Fianco finale sp. 2,8 cm per contenitore BLOCK / End side th. 2,8 cm for BLOCK cabinet
1	KCA32	261,0	87,6	56,8	Cabina armadio lineare CARRY tipo 1 / CARRY linear closet type 1
1	LR81S	103,8	205,6	95,4	Contenitore BLOCK orizzontale senza fianchi con letto singolo e piano scrittoio / Horizontal BLOCK cabinet without sides with single bed and desk
1	LW03X	73,0	99,5	211,0	Letto SYSTEM STAR singolo imbottito fisso con testata H.58.5 cm / SYSTEM STAR upholstered single fixed bed with headboard H.58.5 cm
1	MG58	2,8	33,4	56,8	Mensola per elemento terminale con schiena / Shelf for end unit with back
1	ML94	40,8	36,0	31,1	Contenitore pensile in metallo con 1 vano / Wall metal box with 1 section
2	MQ66A	40,8	74,0	31,1	Elemento pensile orizzontale con 2 vani a giorno e 1 anta doppia / Horizontal wall box with 2 open sections and 1 double door
1	P891N	261,0	132,0	56,8	Ponte lineare SPAZIO 5 con 3 ante battenti / SPAZIO 5 linear bridge with 3 hinged doors
1	P968	261,0	8,0	56,8	Elemento terminale di sostegno in metallo e fianco per elemento pensile H.96 cm / End metal support and side for wall unit H.96 cm
2	PX78	10,0	18,0	3,2	Maniglia rettangolare / Rectangular handle
1	SE72	90,5	65,0	65,0	Sedia con ruote e regolabile in altezza con scocca in legno e basamento in metallo / Chair on castors adjustable in height with wooden structure and metal base
1	SE79	90,5	65,0	65,0	Seduta imbottita sfoderabile per SE72 e SE76 / Upholstered and removable seat for SE72 and SE76
1	T514	165,0	46,8	33,4	Colonna libreria SYSTEM 28 da comp. 333 / Bookcase column SYSTEM 28 from comp. 333
1	T515	197,0	46,8	33,4	Colonna libreria SYSTEM 28 da comp. 333 / Bookcase column SYSTEM 28 from comp. 333

INGOMBRI / DIMENSIONS

CONFIGURATION
333

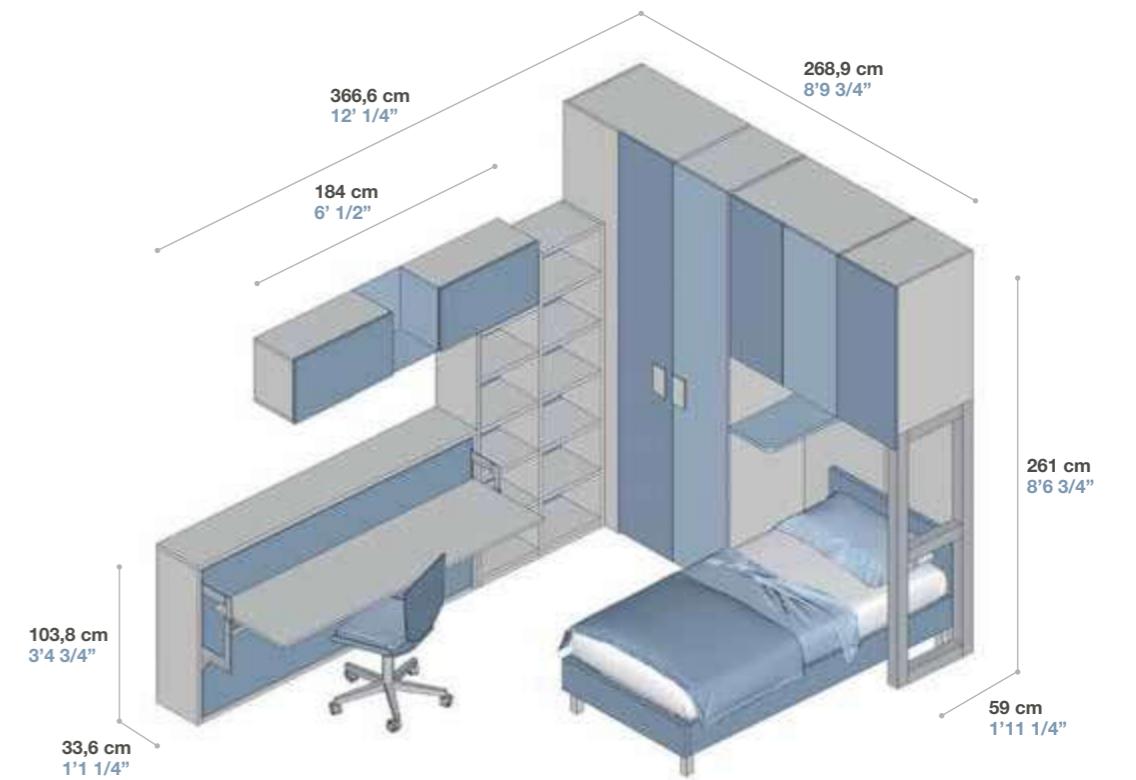

FINITURE / FINISHES

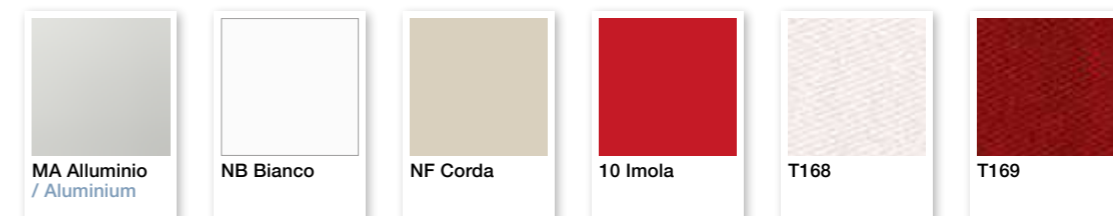

CONFIGURATION
334





DESCRIZIONE TECNICA / TECHNICAL DATA

Q.TA Q.TY	CODICE CODE	A / H	L / W	P / D	DESCRIZIONE / DESCRIPTION
1	B146	261,0	85,6	56,8	Colonna armadio 2 ante / Column wardrobe 2 doors
1	BF44	133,0	56,3	2,5	Boiserie SPAZIO5 / SPAZIO5 wall panels
1	CSL25	34,0	52,3	43,7	Comodino con ruote e 2 cassetti / Night table on castors with 2 drawers
1	FF36	197,0	2,8	33,4	Fianco SYSTEM 28 / SYSTEM 28 Side
2	FN48	261,0	3,2	59,0	Fianco SYSTEM 32 / SYSTEM 32 Side
1	FX54	128,0	2,0	59,0	Fianco SYSTEM 20 / SYSTEM 20 Side
1	GR23	73,2	4,0	59,0	Gamba telaio in metallo / Frame leg in metal
1	LH03X	73,0	98,0	208,6	Letto SYSTEM STAR singolo fisso con testata H.58.5 cm / SYSTEM STAR single fixed bed with headboard H.58.5 cm
2	ME32	2,8	56,6	30,9	Mensola lineare con reggimensola a scomparsa / Linear shelf with concealed bracket
1	MGT56	132,6	56,3	2,5	Maggiorazione per coppia di livellatori / Supplement for couple of level adjusters
1	MJB927	4,0	160,0	59,0	Piano sagomato sp.4 cm COMPO 927 / Shaped top th.4 cm COMPO 927
1	MQ68A	40,8	110,0	31,1	Elemento pensile orizzontale con 3 vani a giorno e 1 anta tripla / Horizontal wall box with 3 open sections and 1 triple door
1	P900N	261,0	220,0	56,8	Ponte lineare SPAZIO 5 con 5 ante battenti / SPAZIO 5 linear bridge with 5 hinged doors
7	PX35L	8,0	8,0	4,7	Pomolo ovale in frassino laccato / Oval knob in lacquered ash
1	PX36L	11,0	11,0	4,7	Pomolo ovale in frassino laccato / Oval knob in lacquered ash
1	SE72	90,5	65,0	65,0	Sedia con ruote e regolabile in altezza con scocca in legno e basamento in metallo / Chair on castors adjustable in height with wooden structure and metal base
1	SE79	90,5	65,0	65,0	Seduta imbottita sfoderabile per SE72 e SE76 / Upholstered and removable seat for SE72 and SE76
1	T145	197,0	46,8	33,4	Colonna libreria SYSTEM 28 / Bookcase column SYSTEM 28
1	T400	133,0	46,8	33,4	Colonna libreria SYSTEM 28 / Bookcase column SYSTEM 28

INGOMBRI / DIMENSIONS

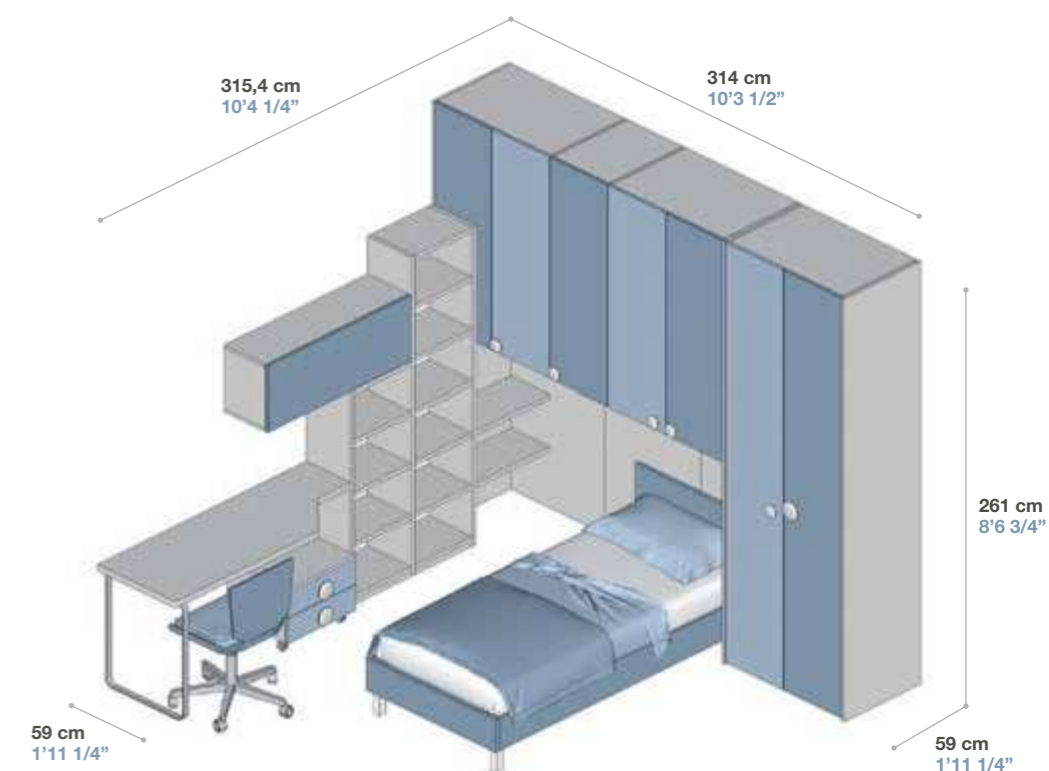
CONFIGURATION
334

FINITURE / FINISHES

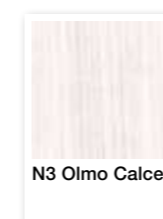



#CANDY PRINCESS

PONTI CON TERMINALE

Bridges with end unit



CONFIGURATION
335





Configuration 335

DESCRIZIONE TECNICA / TECHNICAL DATA

Q.TA Q.TY	CODICE CODE	A / H	L / W	P / D	DESCRIZIONE / DESCRIPTION
1	B134	261,0	41,6	56,8	Colonna armadio 1 anta / Column wardrobe 1 door
1	B139	261,0	41,6	56,8	Colonna armadio 1 anta e 4 cassetti / Column wardrobe 1 door and 4 drawers
2	FN48	261,0	3,2	59,0	Fianco SYSTEM 32 / SYSTEM 32 Side
1	FN58	261,0	2,5	56,8	Divisore intermedio / Intermediate Partition
1	JY01	71,0	102,8	58,1	Contenitore retroletto JOY con ribalta e 2 ante / JOY back-headboard storage unit with tilt door and 2 doors
1	LR36	62,1	95,0	203,5	Letto LORY singolo inferiore scorrevole su ruote con rete a doghe e 2 cassettoni / LORY lower single bed sliding on castors with slatted base and 2 drawers
1	MF18	2,8	103,0	25,0	Mensola lineare con reggimensola a scomparsa / Linear shelf with concealed bracket
1	MGLJYPR	2,0	102,8	56,5	Maggiorazione laccatura piano e ribalta Joy / Supplement for lacquering of Joy top and tilt door
1	P907N	261,0	279,0	105,5	Ponte angolare SPAZIO 5 con 6 ante battenti / SPAZIO 5 corner bridge with 6 hinged doors
1	P918	261,0	33,4	59,0	Elemento terminale libreria con 7 ripiani con schiena H.96 cm / End bookcase unit with 7 shelves and back H.96 cm
1	PX18	5,5	6,2	2,5	Maniglia triangolare / Triangular handle
1	PX19	5,0	5,0	2,7	Pomolo ovale / Oval Knobs
11	PX77	5,0	5,0	3,2	Maniglia quadrata / Square handle
1	PX78	10,0	18,0	3,2	Maniglia rettangolare / Rectangular handle
1	UV99	100,0	624,7	0,1	Stampa digitale su pannello con immagine archivio Tumidei o cliente / Digital print on panel with image from Tumidei' library or from customer

INGOMBRI / DIMENSIONS

CONFIGURATION
335

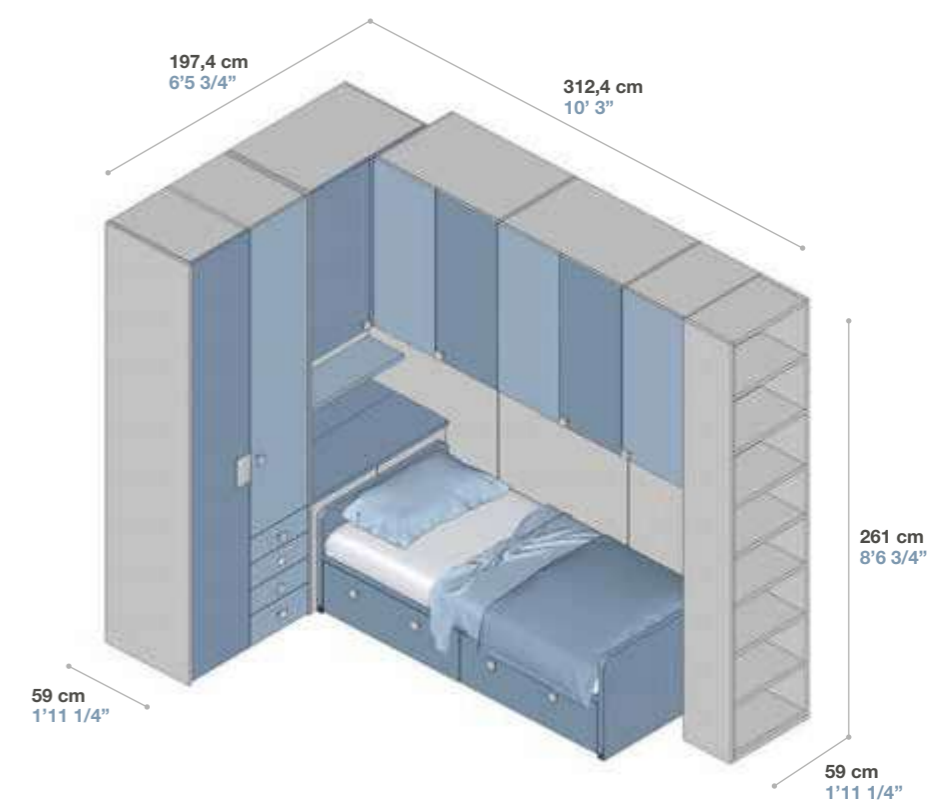

FINITURE / FINISHES

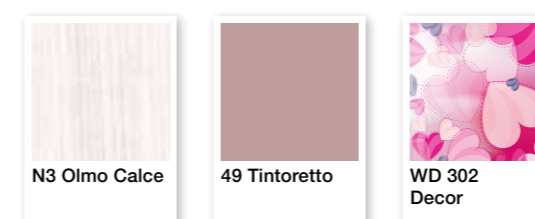

CONFIGURATION
336



DESCRIZIONE TECNICA / TECHNICAL DATA

Q.TA Q.TY	CODICE CODE	A / H	L / W	P / D	DESCRIZIONE / DESCRIPTION
1	B134	261,0	41,6	56,8	Colonna armadio 1 anta / Column wardrobe 1 door
1	B139	261,0	41,6	56,8	Colonna armadio 1 anta e 4 cassetti / Column wardrobe 1 door and 4 drawers
2	FN48	261,0	3,2	59,0	Fianco SYSTEM 32 / SYSTEM 32 Side
1	FN58	261,0	2,5	56,8	Divisore intermedio / Intermediate Partition
1	JY02	103,0	102,8	58,1	Contenitore retroletto JOY con ribalta e 2 ante / JOY back-headboard storage unit with tilt door and 2 doors
1	LR36	62,1	95,0	203,5	Letto LORY singolo inferiore scorrevole su ruote con rete a doghe e 2 cassettoni / LORY lower single bed sliding on castors with slatted base and 2 drawers
1	LR37	95,7	97,0	214,5	Letto LORY singolo superiore scorrevole su ruote con rete a doghe / LORY upper single bed sliding on castors with slatted base
1	MF18	2,8	103,0	25,0	Mensola lineare con reggimensola a scomparsa / Linear shelf with concealed bracket
1	MGLJYPR	2,0	102,8	54,5	Maggiorazione laccatura piano e ribalta Joy / Supplement for lacquering of Joy top and tilt door
1	P907N	261,0	279,0	105,5	Ponte angolare SPAZIO 5 con 6 ante battenti / SPAZIO 5 corner bridge with 6 hinged doors
1	P918	261,0	33,4	59,0	Elemento terminale libreria con 7 ripiani con schiena H.96 cm / End bookcase unit with 7 shelves and back H.96 cm
4	PX25LL	4,0	8,0	0,2	Maniglia ad incasso rettangolare con fondo e bordo laccato / Recessed rectangular handle with lacquered back and edge
6	PX26LL	4,0	20,0	0,2	Maniglia ad incasso rettangolare con fondo e bordo laccato / Recessed rectangular handle with lacquered back and edge
1	PX27LL	4,0	40,0	0,2	Maniglia ad incasso rettangolare con fondo e bordo laccato / Recessed rectangular handle with lacquered back and edge
1	PX28LL	4,0	80,0	0,2	Maniglia ad incasso rettangolare con fondo e bordo laccato / Recessed rectangular handle with lacquered back and edge
1	UV99	100,0	624,7	0,1	Stampa digitale su pannello con immagine archivio Tumidei o cliente / Digital print on panel with image from Tumidei' library or from customer

INGOMBRI / DIMENSIONS

CONFIGURATION
336

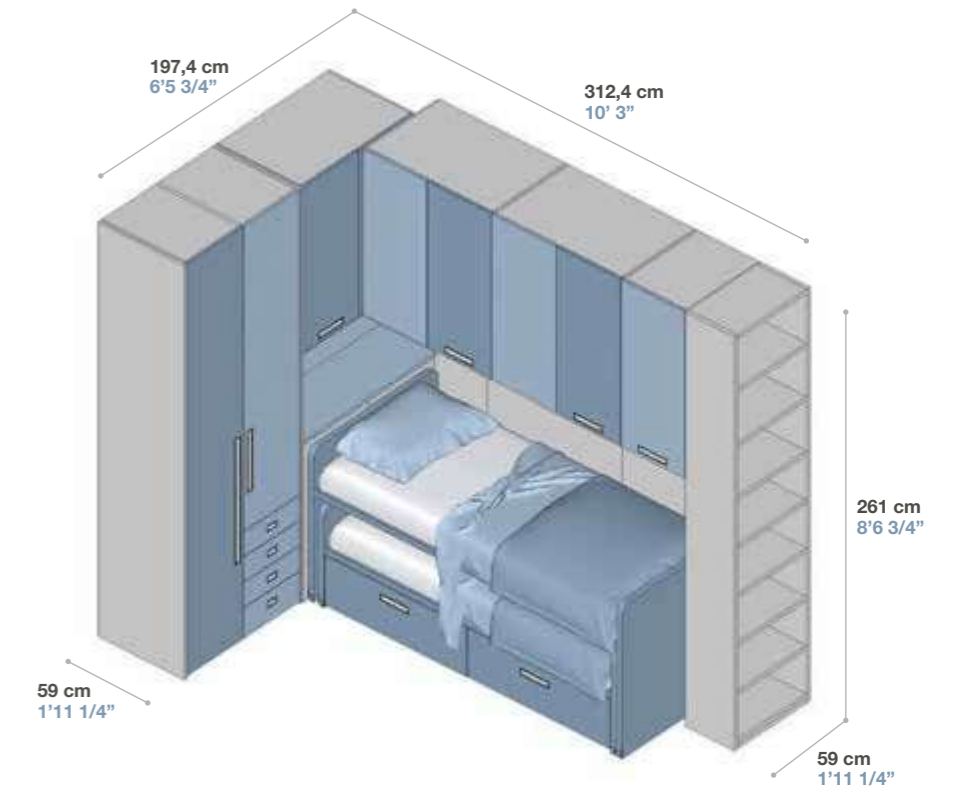

FINITURE / FINISHES



CONFIGURATION
337





DESCRIZIONE TECNICA / TECHNICAL DATA

Q.TA Q.TY	CODICE CODE	A / H	L / W	P / D	DESCRIZIONE / DESCRIPTION
1	B134	261,0	41,6	56,8	Colonna armadio 1 anta / Column wardrobe 1 door
1	B139	261,0	41,6	56,8	Colonna armadio 1 anta e 4 cassetti / Column wardrobe 1 door and 4 drawers
2	FN48	261,0	3,2	59,0	Fianco SYSTEM 32 / SYSTEM 32 Side
1	FN58	261,0	2,5	56,8	Divisore intermedio / Intermediate Partition
1	JY02	103,0	102,8	58,1	Contenitore retroletto JOY con ribalta e 2 ante / JOY back-headboard storage unit with tilt door and 2 doors
1	LR36	62,1	95,0	203,5	Letto LORY singolo inferiore scorrevole su ruote con rete a doghe e 2 cassettoni / LORY lower single bed sliding on castors with slatted base and 2 drawers
1	LR38	76,0	95,0	214,5	Scrivania scorrevole spessore 4 cm / Sliding desk thickness 4 cm
1	MF18	2,8	103,0	25,0	Mensola lineare con reggimensola a scomparsa / Linear shelf with concealed bracket
1	MGLJYPR	2,0	102,8	56,5	Maggiorazione laccatura piano e ribalta Joy / Supplement for lacquering of Joy top and tilt door
1	P907N	261,0	279,0	105,5	Ponte angolare SPAZIO 5 con 6 ante battenti / SPAZIO 5 corner bridge with 6 hinged doors
1	P918	261,0	33,4	59,0	Elemento terminale libreria con 7 ripiani con schiena H.96 cm / End bookcase unit with 7 shelves and back H.96 cm
4	PX25LL	4,0	8,0	0,2	Maniglia ad incasso rettangolare con fondo e bordo laccato / Recessed rectangular handle with lacquered back and edge
6	PX26LL	4,0	20,0	0,2	Maniglia ad incasso rettangolare con fondo e bordo laccato / Recessed rectangular handle with lacquered back and edge
1	PX27LL	4,0	40,0	0,2	Maniglia ad incasso rettangolare con fondo e bordo laccato / Recessed rectangular handle with lacquered back and edge
1	PX28LL	4,0	80,0	0,2	Maniglia ad incasso rettangolare con fondo e bordo laccato / Recessed rectangular handle with lacquered back and edge
1	SE72	90,5	65,0	65,0	Sedia con ruote e regolabile in altezza con scocca in legno e basamento in metallo / Chair on castors adjustable in height with wooden structure and metal base
1	SE79	90,5	65,0	65,0	Seduta imbottita sfoderabile per SE72 e SE76 / Upholstered and removable seat for SE72 and SE76

INGOMBRI / DIMENSIONS

CONFIGURATION
337

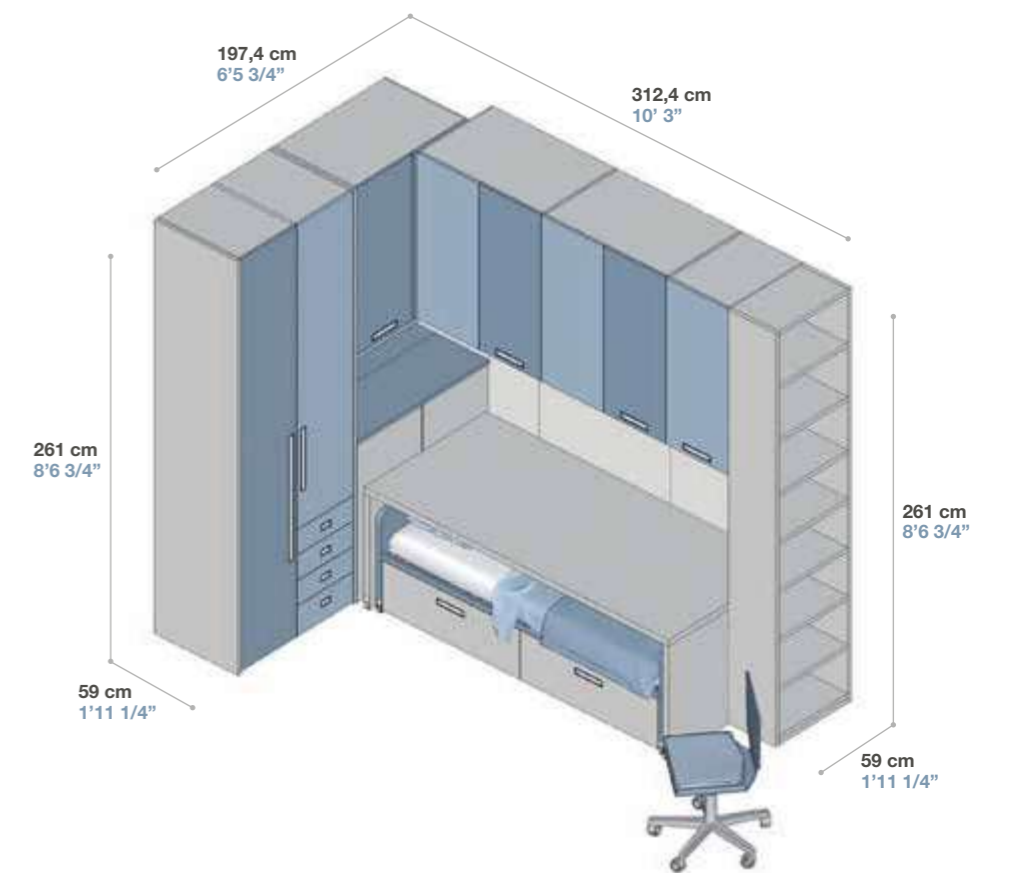

FINITURE / FINISHES

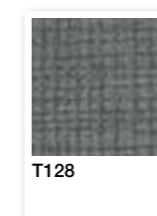
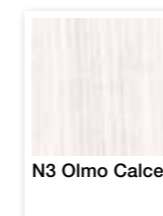

#SKATERS BOY AND GIRL

PONTI CON TERMINALE

Bridges with end unit



Configuration 338

CONFIGURATION
338





Configuration 338

DESCRIZIONE TECNICA / TECHNICAL DATA

Q.TA Q.TY	CODICE CODE	A / H	L / W	P / D	DESCRIZIONE / DESCRIPTION
1	B194	261,0	85,6	102,0	Colonna armadio 2 ante / Column wardrobe 2 doors
2	FNA48	261,0	3,2	104,2	Fianco SYSTEM 32 / SYSTEM 32 Side
1	LR36	62,1	95,0	203,5	Letto LORY singolo inferiore scorrevole su ruote con rete a doghe e 2 cassettoni / LORY lower single bed sliding on castors with slatted base and 2 drawers
1	LR37	95,7	97,0	214,5	Letto LORY singolo superiore scorrevole su ruote con rete a doghe / LORY upper single bed sliding on castors with slatted base
1	MGLLR36	0,0	0,0	0,0	Maggiorazione laccatura coppia cassetti letto / Supplement for couple of bed drawers in lacquered
1	P894N	261,0	220,0	56,8	Ponte lineare SPAZIO 5 con 5 ante battenti / SPAZIO 5 linear bridge with 5 hinged doors
1	P918	261,0	33,4	59,0	Elemento terminale libreria con 7 ripiani con schiena H.96 cm / End bookcase unit with 7 shelves and back H.96 cm
9	PM42	1,5	33,8	3,5	Maniglia rettangolare / Rectangular handle

INGOMBRI / DIMENSIONS

CONFIGURATION

338

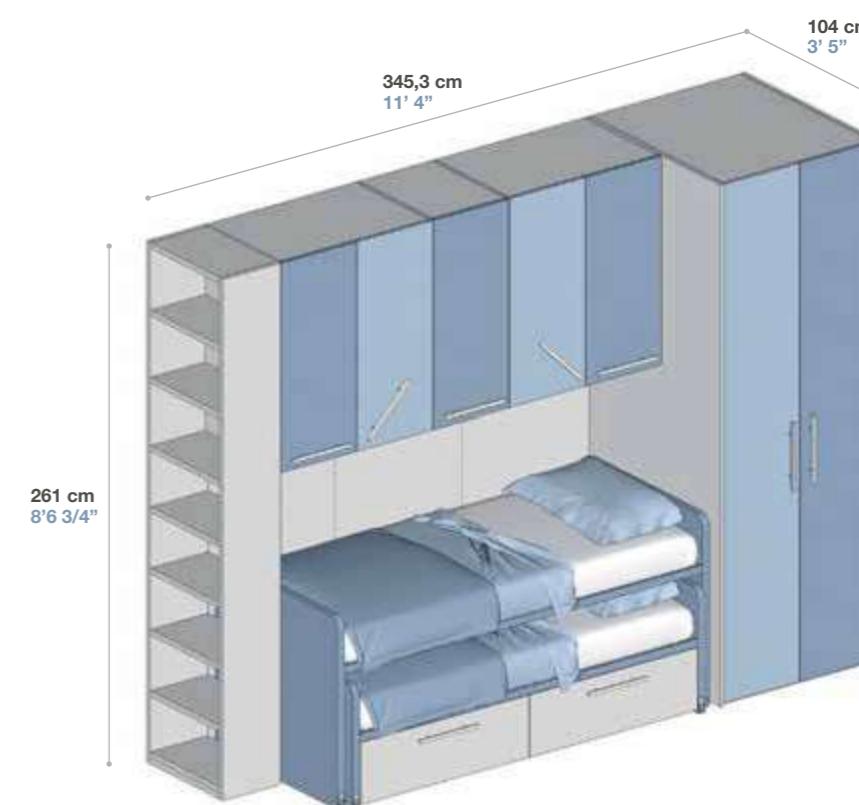

FINITURE / FINISHES

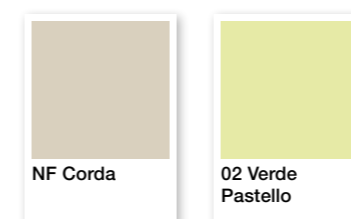

CONFIGURATION
339





Configuration 339

DESCRIZIONE TECNICA / TECHNICAL DATA

Q.TA Q.TY	CODICE CODE	A / H	L / W	P / D	DESCRIZIONE / DESCRIPTION
1	CSL33	50,0	37,5	43,7	Comodino con ruote con 3 cassetti / Night table on castors with 3 drawers
1	FN08	261,0	2,0	56,8	Fianco SYSTEM 20 / SYSTEM 20 Side
1	FX53	96,0	2,0	56,8	Fianco SYSTEM 20 / SYSTEM 20 Side
1	KCA34	261,0	117,2	56,8	Cabina armadio lineare CARRY tipo 2 / CARRY linear closet type 2
1	LH03X	73,0	98,0	208,6	Letto SYSTEM STAR singolo fisso con testata H.58.5 cm / SYSTEM STAR single fixed bed with headboard H.58.5 cm
3	ML84	24,0	50,0	25,0	Mensola in metallo con fianchi e schiena in legno spessore 2 cm / Metal shelf with sides and wooden back thickness 2 cm
2	MQA63	82,7	66,3	33,4	Elemento multivano a terra con 4 vani a giorno / Floor multi-sections cabinet with 4 open sections
1	MQA64	82,7	66,3	33,4	Elemento multivano a terra con 4 vani a giorno / Floor multi-sections cabinet with 4 open sections
2	MQA83	82,3	66,3	33,4	Elemento multivano pensile con 4 vani a giorno / Wall multi-sections cabinet with 4 open sections
1	MQA84	82,3	66,3	33,4	Elemento multivano pensile con 4 vani a giorno / Wall multi-sections cabinet with 4 open sections
1	PE43K	96,0	44,0	56,8	Elemento pensile per ponti lineari con 1 anta in sovrapposizione / Wall element for linear bridges with 1 overlapping door
1	PE63K	96,0	88,0	56,8	Elemento pensile per ponti lineari con 2 ante in sovrapposizione / Wall element for linear bridges with 2 overlapping doors
2	PX26LL	4,0	20,0	0,2	Maniglia ad incasso rettangolare con fondo e bordo laccato / Recessed rectangular handle with lacquered back and edge
1	PX29LL	4,0	120,0	0,2	Maniglia ad incasso rettangolare con fondo e bordo laccato / Recessed rectangular handle with lacquered back and edge
1	SE72	90,5	65,0	65,0	Sedia con ruote e regolabile in altezza con scocca in legno e basamento in metallo / Chair on castors adjustable in height with wooden structure and metal base
1	SE79	90,5	65,0	65,0	Seduta imbottita sfoderabile per SE72 e SE76 / Upholstered and removable seat for SE72 and SE76
1	TQ32	77,2	166,6	59,2	Scrivania spessore 4 cm predisposto per aggancio a muro o pannello / Desk thickness 4 cm set up for wall or panel fixing

INGOMBRI / DIMENSIONS

CONFIGURATION

339

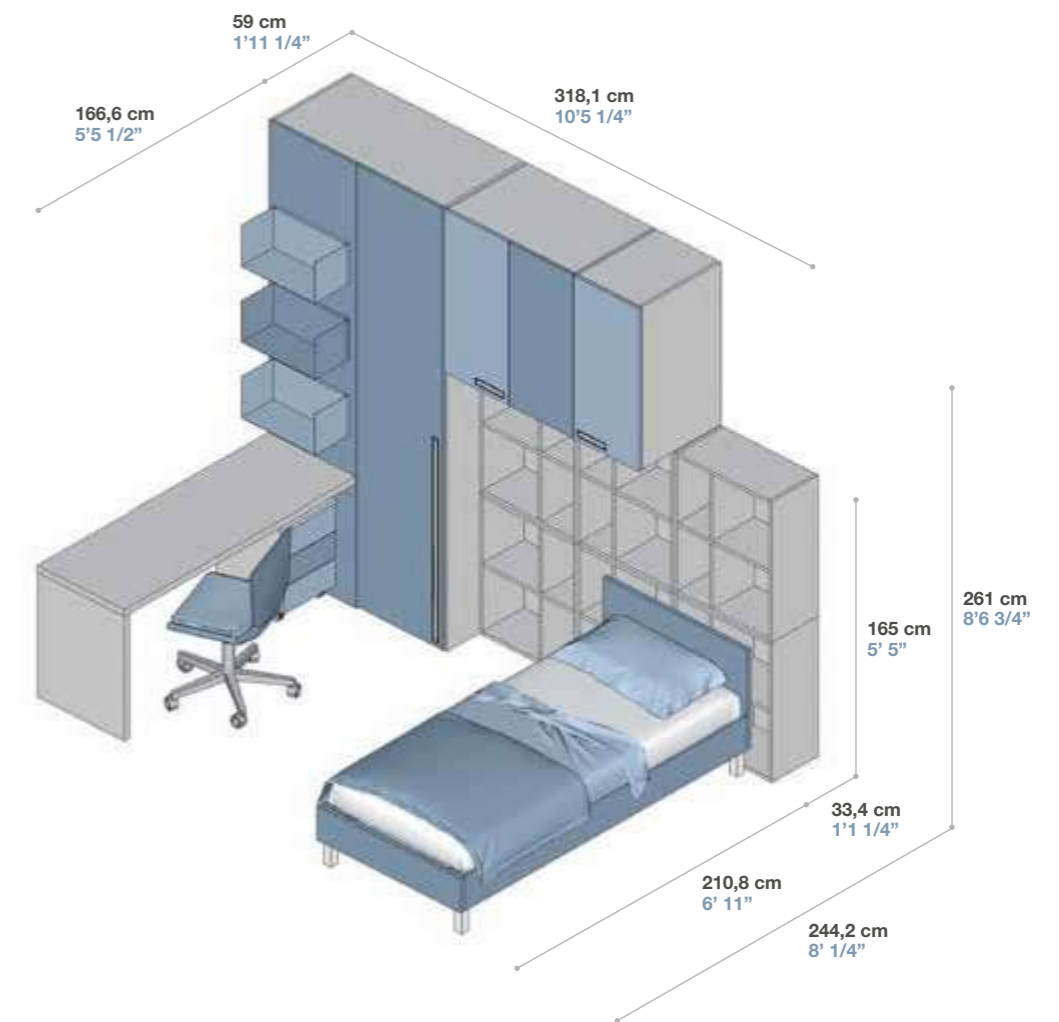

FINITURE / FINISHES



#COOL WRITERS

EASY
Easy system

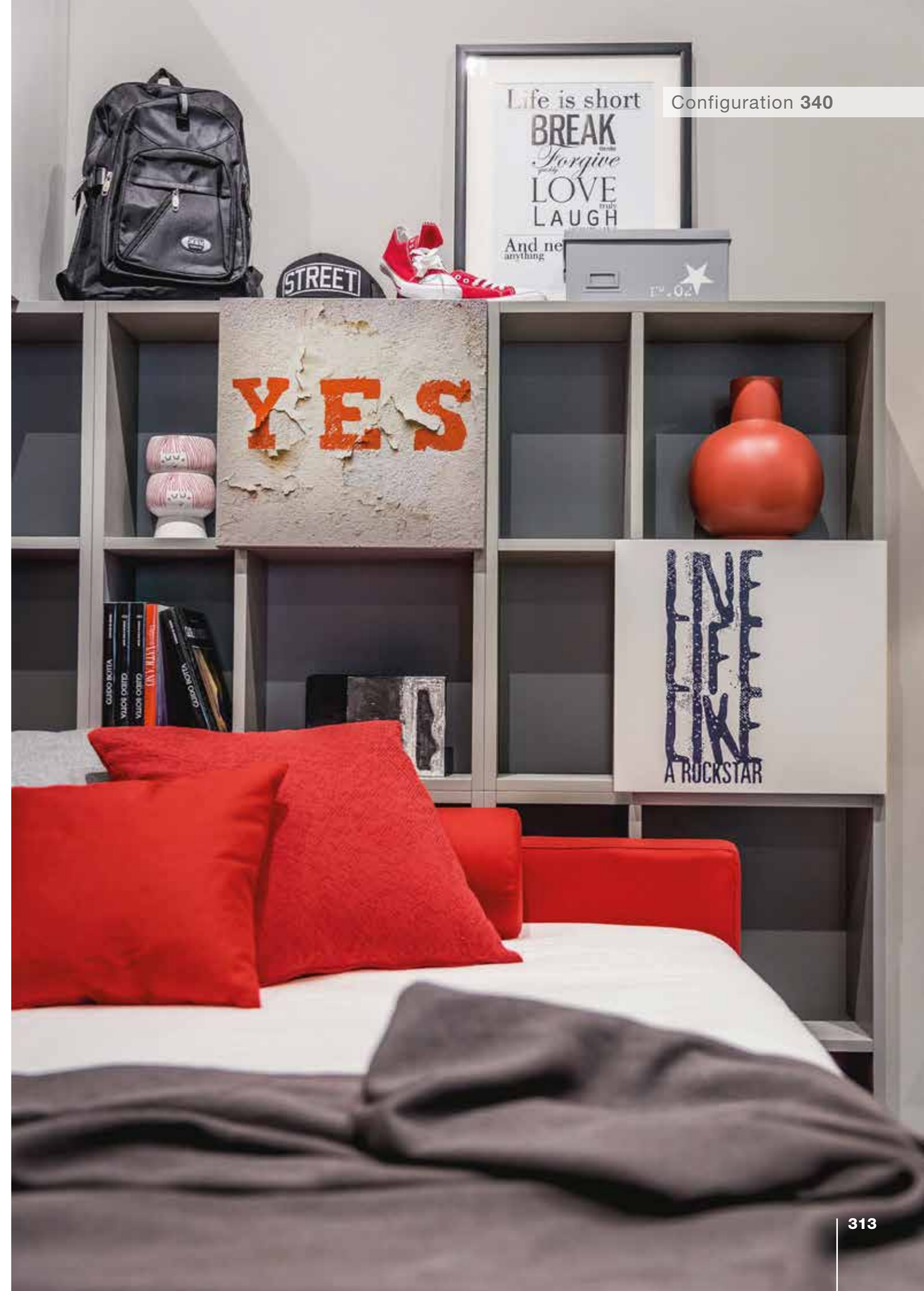

CONFIGURATION
340





Configuration 340



DESCRIZIONE TECNICA / TECHNICAL DATA

Q.TA Q.TY	CODICE CODE	A / H	L / W	P / D	DESCRIZIONE / DESCRIPTION
1	B141	261,0	56,4	56,8	Colonna armadio 1 anta / Column wardrobe with 1 door
1	CSL36	50,0	37,5	43,7	Comodino con ruote con 1 cassetto e 1 cassettono / Night table on castors with 1 drawer and 1 high drawer
1	FN48	261,0	3,2	59,0	Fianco SYSTEM 32 / SYSTEM 32 Side
1	FN58	261,0	2,5	56,8	Divisore intermedio / Intermediate Partition
1	FX53	96,0	2,0	59,0	Fianco SYSTEM 20 / SYSTEM 20 Side
1	KCA34	261,0	117,2	56,8	Cabina armadio lineare CARRY tipo 2 / CARRY linear closet type 2
1	LX39X	75,0	128,5	217,0	Letto SYSTEM SCRIGNO 1 piazza e mezza imbottito fisso con testata H.75 cm e spessore 10 cm / SYSTEM SCRIGNO upholstered 3/4 fixed bed with headboard H.75 cm th.10 cm
2	ML84	24,0	50,0	25,0	Mensola in metallo con fianchi e schiena in legno spessore 2 cm / Metal shelf with sides and wooden back thickness 2 cm
3	MQA63	82,7	66,3	33,4	Elemento multivano a terra con 4 vani a giorno / Floor multi-sections cabinet with 4 open sections
1	MQA68	82,7	66,3	33,4	Elemento multivano a terra con 3 vani a giorno e 1 anta / Floor multi-sections cabinet with 3 open sections and 1 door
2	MQA87	82,3	66,3	33,4	Elemento multivano pensile con 3 vani a giorno e 1 anta / Wall multi-sections cabinet with 3 open sections and 1 door
1	MQA91	82,3	66,3	33,4	Elemento multivano pensile con 3 vani a giorno e 1 anta / Wall multi-sections cabinet with 3 open sections and 1 door
1	MQA92	82,3	66,3	33,4	Elemento multivano pensile con 3 vani a giorno e 1 anta / Wall multi-sections cabinet with 3 open sections and 1 door
1	PE66K	96,0	117,6	56,8	Elemento pensile per ponti lineari con 2 ante in sovrapposizione / Wall element for linear bridges with 2 overlapping doors
2	PX76	100,0	10,0	3,2	Maniglia rettangolare con stampa digitale / Rectangular handle with digital print
1	SE10	97,0	65,0	65,0	Sedia con ruote e regolabile in altezza con scocca imbottita sfoderabile e basamento in metallo / Chair on castors adjustable in height with upholstered and removable structure and metal base
1	TQ82	24,0	166,6	59,0	Scrivania pensile spessore 4 cm con fascia H.20 cm / Wall desk thickness 4 cm with strip H.20 cm
3	UV99	100,0	100,0	0,1	Stampa digitale su pannello con immagine archivio Tumidei o cliente / Digital print on panel with image from Tumidei' library or from customer
2	ZM40	95,7	0,0	0,0	Apertura push-pull / Push-pull opening

INGOMBRI / DIMENSIONS

CONFIGURATION
340

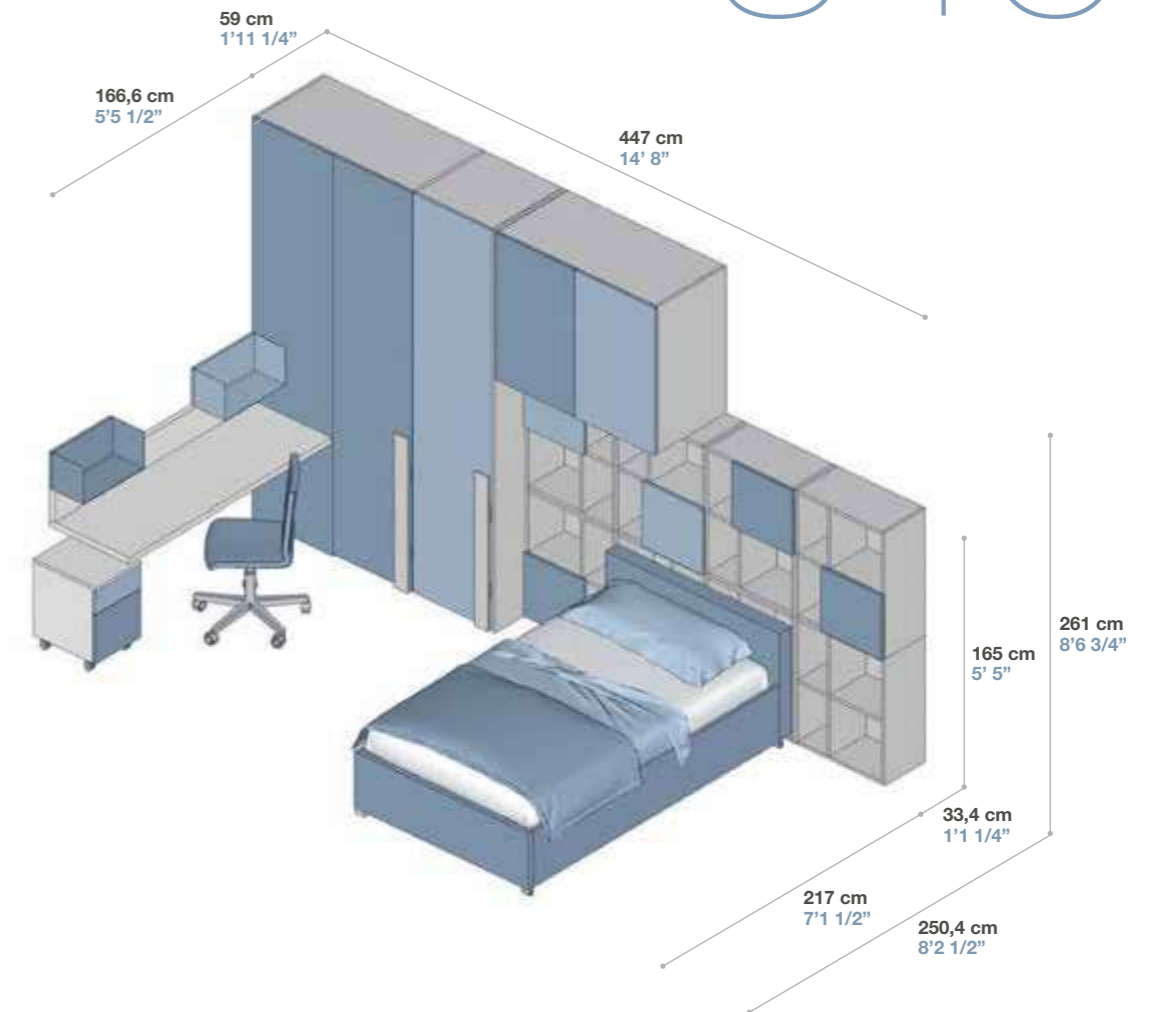

FINITURE / FINISHES

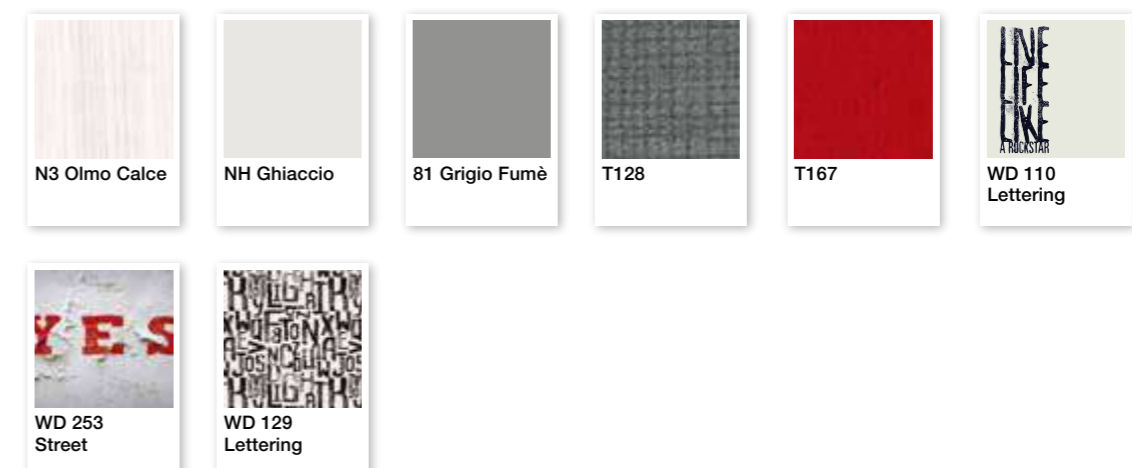





DESCRIZIONE TECNICA / TECHNICAL DATA

Q.TA Q.TY	CODICE CODE	A / H	L / W	P / D	DESCRIZIONE / DESCRIPTION
2	B127	229,0	85,6	56,8	Colonna armadio 2 ante / Column wardrobe 2 doors
2	FN47	229,0	3,2	59,0	Fianco SYSTEM 32 / SYSTEM 32 Side
1	FN57	229,0	2,5	56,8	Divisore intermedio / Intermediate partition
1	LD71X	99,0	113,6	223,9	Letto EVO singolo imbottito con testata imbottita / EVO upholstered single bed with headboard
2	MGLTC13	30,0	30,0	2,0	Maggiorazione laccatura schiena / Supplement for back lacquering
1	MQ68A	40,8	110,0	31,1	Elemento pensile orizzontale con 3 vani a giorno e 1 anta tripla / Horizontal wall box with 3 open sections and 1 triple door
1	MQ73	18,0	52,3	41,5	Comodino pensile con 1 cassetto / Hanging night table with 1 drawer
2	PX79	10,0	18,0	3,2	Maniglia rettangolare con stampa digitale / Rectangular handle with digital print
1	SE10	97,0	65,0	65,0	Sedia con ruote e regolabile in altezza con scocca imbottita sfoderabile e basamento in metallo / Chair on castors adjustable in height with upholstered and removable structure and metal base
1	TC01	98,0	66,0	27,5	Elemento pensile T-CLOUD con 4 vani a giorno / T-CLOUD wall box with 4 open sections
1	TC02	130,0	130,0	27,5	Elemento pensile T-CLOUD con 8 vani a giorno / T-CLOUD wall box with 8 open sections
1	TQ81	24,0	133,4	59,0	Scrivania pensile spessore 4 cm con fascia H.20 cm / Wall desk thickness 4 cm with strip H.20 cm
1	UV99	100,0	397,0	0,1	Stampa digitale su pannello con immagine archivio Tumidei o cliente / Digital print on panel with image from Tumidei' library or from customer

INGOMBRI / DIMENSIONS

CONFIGURATION

341

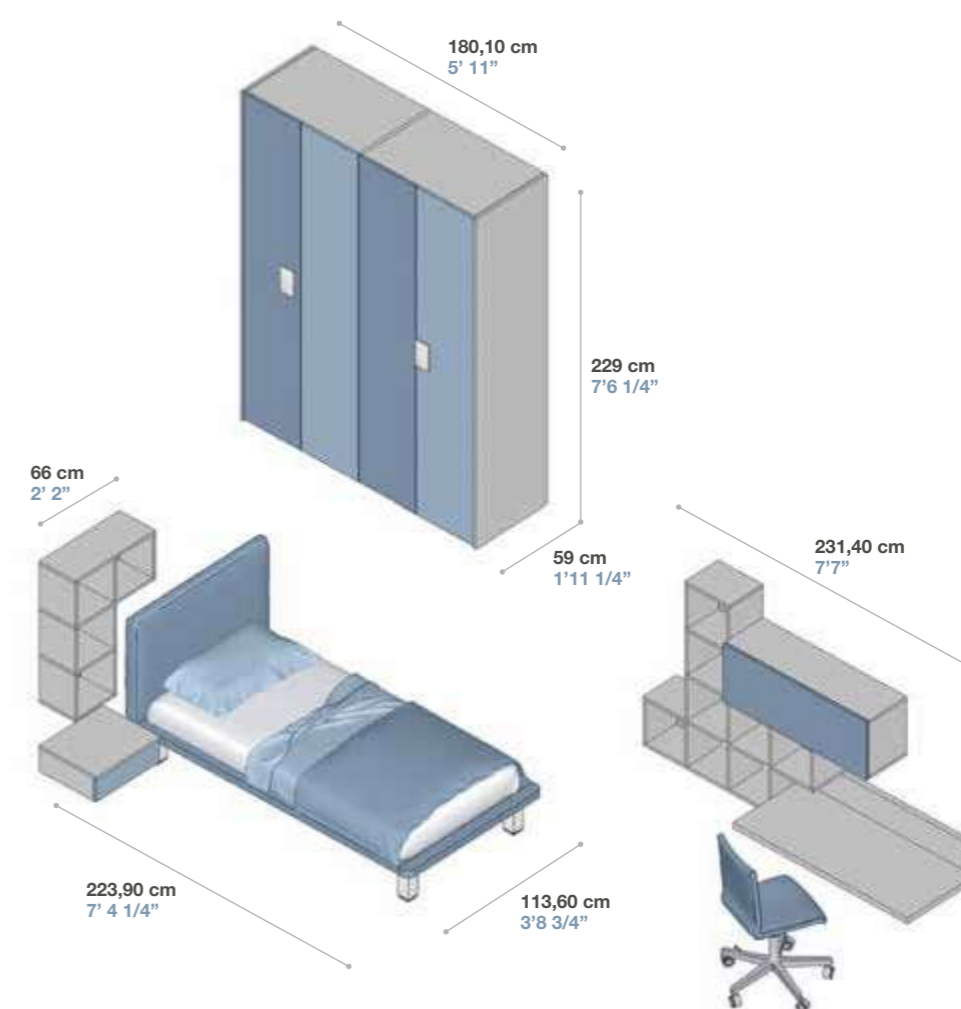

FINITURE / FINISHES

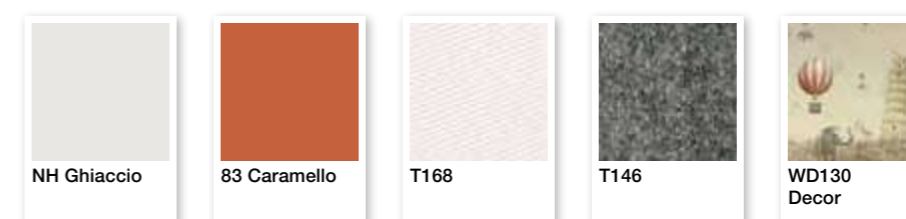



#FRENCH CHIC LADY

EASY
Easy system



CONFIGURATION
342





Q.TA Q.TY	CODICE CODE	A / H	L / W	P / D	DESCRIZIONE / DESCRIPTION
2	B146	261,0	85,6	56,8	Colonna armadio 2 ante / Column wardrobe 2 doors
1	CSL33	50,0	37,5	43,7	Comodino con ruote con 3 cassetti / Night table on castors with 3 drawers
2	FN08	261,0	2,0	56,8	Fianco SYSTEM 20 / SYSTEM 20 Side
1	FN58	261,0	2,5	56,8	Divisore intermedio / Intermediate Partition
1	KK28N6	261,0	33,4	59,0	6 Portascarpe / 6 racks for shoes
1	LWT24	100,0	130,0	208,0	Letto TOMMY L.120 con 2 testate imbottite / TOMMY bed W.120 with 2 upholstered headboards
1	MM58	261,0	33,4	59,0	MAGIC MIRROR elemento terminale con specchio girevole / MAGIC MIRROR end unit with swivel mirror
1	MQA85	66,3	82,3	31,1	Elemento multivano pensile con 3 vani a giorno e 1 anta / Wall multi-sections cabinet with 3 open sections and 1 door
2	MQA86	66,3	82,3	31,1	Elemento multivano pensile con 3 vani a giorno e 1 anta / Wall multi-sections cabinet with 3 open sections and 1 door
1	PM62	259,1	20,0	2,0	Maniglia Code L. 200 per ante H. 2610 / Code handle W.200 for doors H. 2610
3	PM64	259,1	12,0	2,0	Maniglia Code L. 120 per ante H. 2610 / Code handle W.120 for doors H. 2610
1	PUF11	45,0	60,0	60,0	Pouf VIBE / VIBE pouf
1	SE10	97,0	65,0	65,0	Sedia con ruote e regolabile in altezza con scocca imbottita sfoderabile e basamento in metallo / Chair on castors adjustable in height with upholstered and removable structure and metal base
1	TQA66	77,2	150,0	59,2	Scrivania spessore 4 cm con piede Square / Desk thickness 4 cm with Square foot

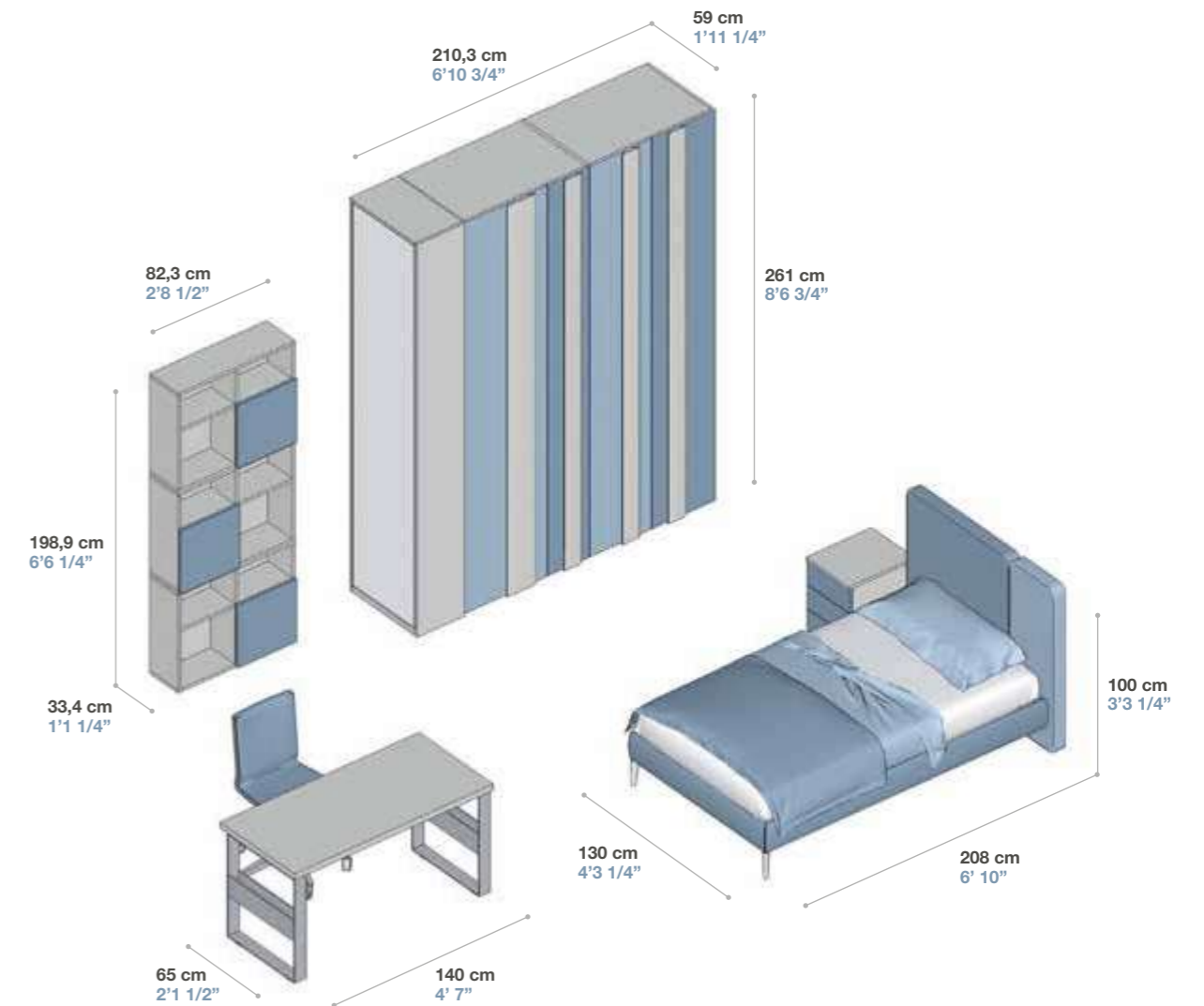

FINITURE / FINISHES

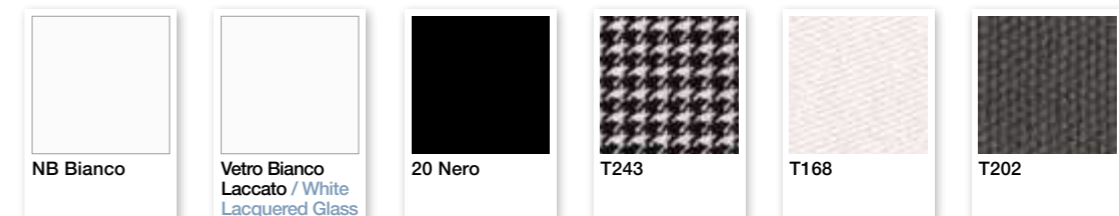



Q.TA Q.TY	CODICE CODE	A / H	L / W	P / D	DESCRIZIONE / DESCRIPTION
1	AR08	261,0	2,8	56,8	Fianco di chiusura / Closing Side
1	AR08	261,0	2,8	60,5	Fianco di chiusura / Closing Side
1	AR35	263,0	173,7	56,8	Armadio 2 ante scorrevoli / Wardrobe 2 sliding doors
1	CSL62	74,7	103,0	43,7	Comodino ROUND con 2 cassetti / ROUND night table with 2 drawers
1	CSL73	123,7	73,8	36,0	Pensile ROUND con 2 ante / ROUND hanging element with 2 doors
1	GR26	73,2	8,0	59,0	Piede Square in metallo / Square foot in metal
1	KKJ6	3,0	55,0	3,0	Supporto angolare in alluminio / Corner support in aluminium
1	LWT21	100,0	90,0	208,0	Letto TOMMY L.90 con 1 testata imbottita / TOMMY bed W.90 with 1 upholstered headboard
1	MY04	4,0	160,0	65,0	Piano sagomato o lineare senza supporti laterali / Shaped or linear top
1	PUF4	46,0	40,0	40,0	Pouf con ruote / Pouf with castors
1	UV99	100,0	463,7	0,1	Stampa digitale su pannello con immagine archivio Tumidei o cliente / Digital print on panel with image from Tumidei' library or from customer
3	VS25	20,0	56,5	20,5	Mensola T-BOX L 56.5 cm / T-BOX shelf W 56.5 cm
3	VS26	20,0	100,0	20,5	Mensola T-BOX L 100 cm / T-BOX shelf W 100 cm

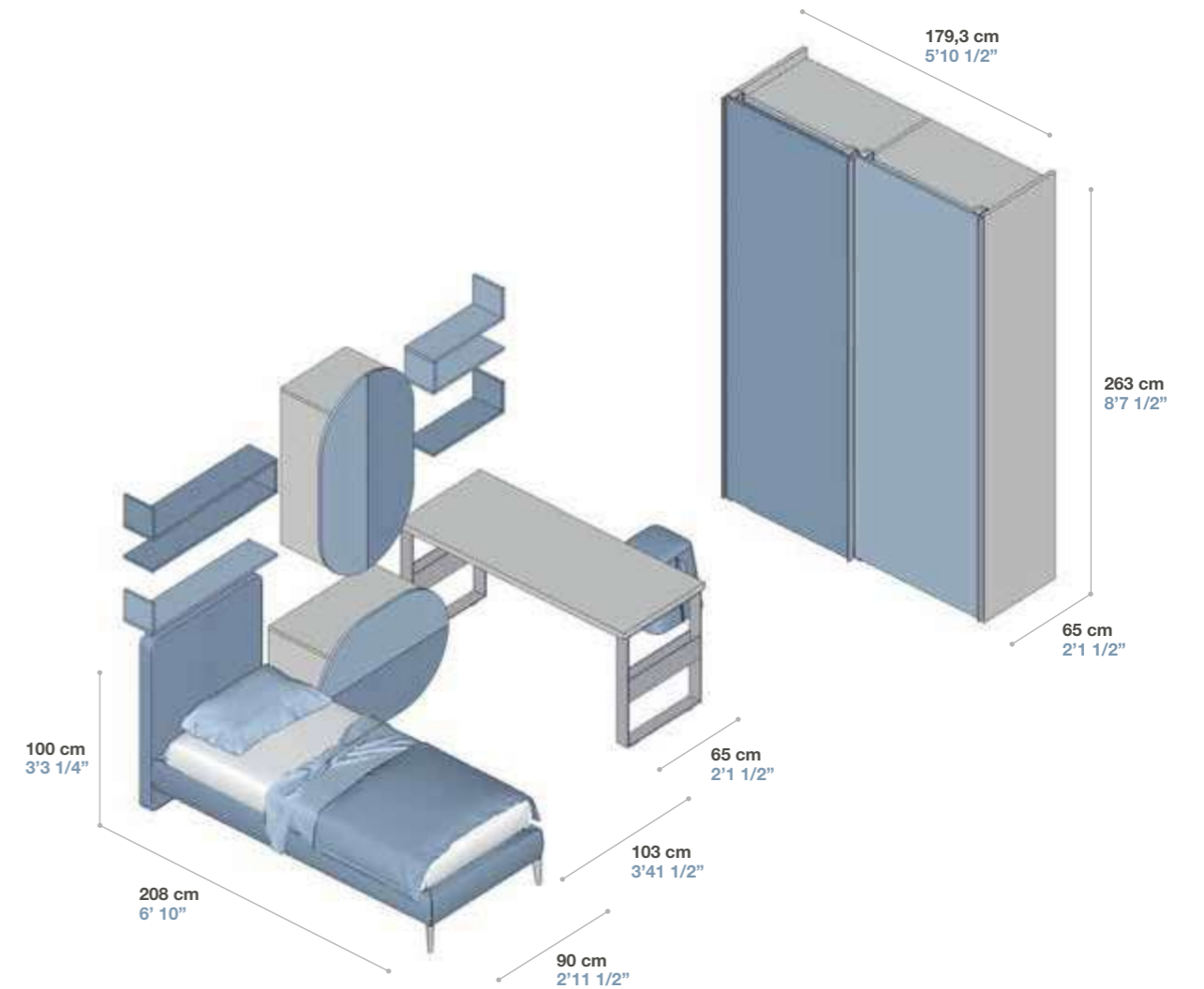

FINITURE / FINISHES



#FASHION BLOGGER

EASY
Easy system







Armadio System 20/32 con ante in vetro temperato.
System 20/32 wardrobe with doors in tempered glass.



Configuration 344

DESCRIZIONE TECNICA / TECHNICAL DATA

Q.TA Q.TY	CODICE CODE	A / H	L / W	P / D	DESCRIZIONE / DESCRIPTION
3	B146	261,0	85,6	56,8	Colonna armadio 2 ante / Column wardrobe 2 doors
1	CSL16	50,0	37,5	43,7	Comodino a terra con 1 cassetto e 1 cassettone / Floor night table with 1 drawer and 1 high drawer
2	FN08	261,0	2,0	56,8	Fianco SYSTEM 20 / SYSTEM 20 Side
2	FN58	261,0	2,5	56,8	Divisore intermedio / Intermediate Partition
1	LWT26	100,0	170,0	208,0	Letto TOMMY L.160 con 3 testate imbottite / TOMMY bed W.160 with 3 upholstered headboards
1	MGLAMQ68	40,4	109,6	2,0	Maggiorazione laccatura anta / Supplement for door lacquering
1	MGLCL1D	17,8	52,0	2,0	Maggiorazione laccatura frontale / Supplement for front part lacquering
1	MGLSTC03	98,0	98,0	27,5	Maggiorazione laccatura struttura T_CLOUD / Supplement for T_CLOUD structure lacquering
2	MGLTC13	30,0	30,0	2,0	Maggiorazione laccatura schiena / Supplement for back lacquering
1	MQ68A	40,8	110,0	31,1	Elemento pensile orizzontale con 3 vani a giorno e 1 anta tripla / Horizontal wall box with 3 open sections and 1 triple door
1	MQ73	18,0	52,3	41,5	Comodino pensile con 1 cassetto / Hanging night table with 1 drawer
1	PUF4	46,0	40,0	40,0	Pouf con ruote / Pouf with castors
1	TC01	66,0	98,0	27,5	Elemento pensile T-CLOUD con 4 vani a giorno / T-CLOUD wall box with 4 open sections
1	TC03	98,0	98,0	27,5	Elemento pensile T-CLOUD con 6 vani a giorno / T-CLOUD wall box with 6 open sections
1	TC71	45,3	42,0	45,5	Vaso Tetris con impianto purificatore / Tetris vase with purifying system
1	TQ81	24,0	133,4	59,0	Scrivania pensile spessore 4 cm con fascia H.20 cm / Wall desk thickness 4 cm with strip H.20 cm
6	ZM40	259,1	0,0	0,0	Apertura push-pull / Push-pull opening

INGOMBRI / DIMENSIONS

CONFIGURATION
344

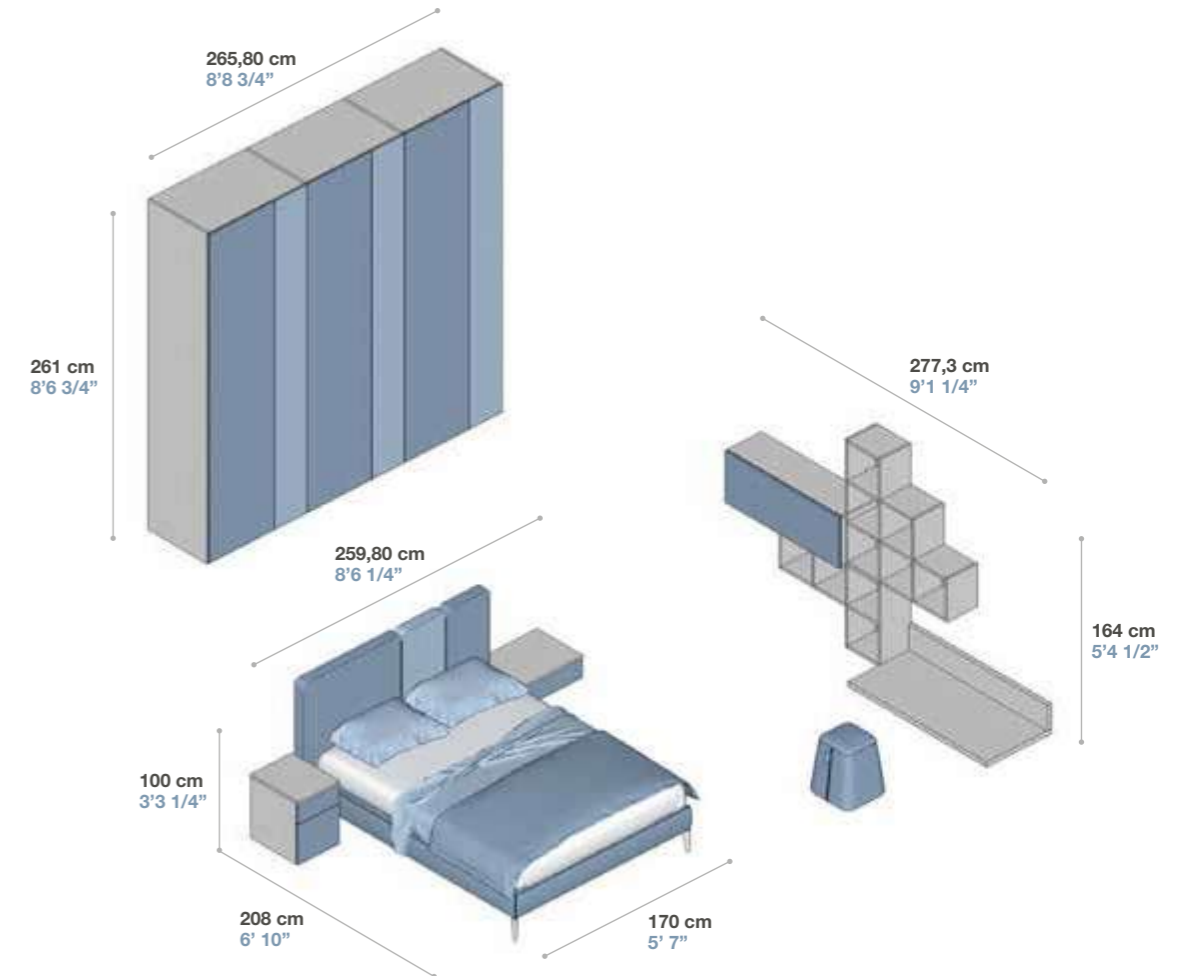

FINITURE / FINISHES

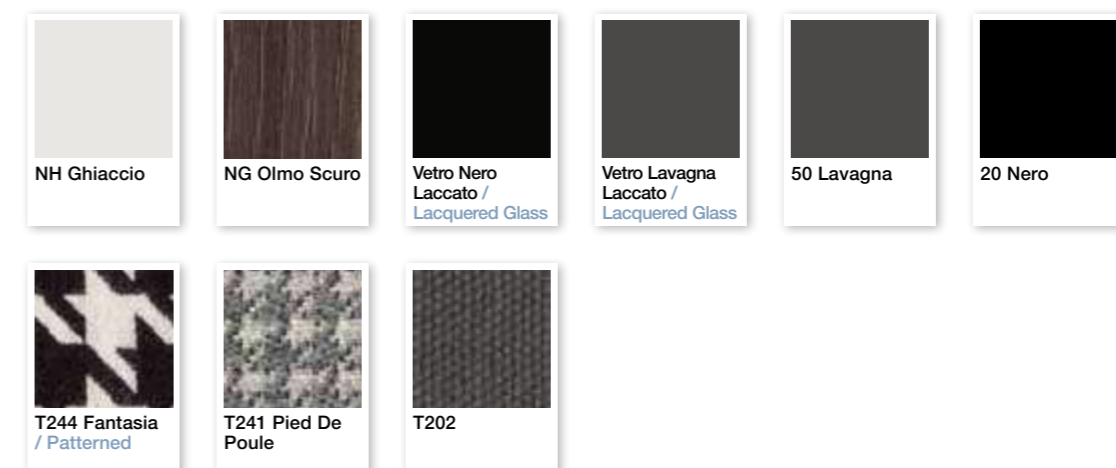



#DREAMER TEEN

EASY
Easy system







DESCRIZIONE TECNICA / TECHNICAL DATA

Q.TA Q.TY	CODICE CODE	A / H	L / W	P / D	DESCRIZIONE / DESCRIPTION
2	B146	261,0	85,6	56,8	Colonna armadio 2 ante / Column wardrobe 2 doors
1	CSL64	57,2	53,0	36,0	Comodino ROUND con 1 anta / ROUND night table with 1 door
1	CSL72	73,8	103,0	36,0	Pensile ROUND con 2 ante / ROUND hanging element with 2 doors
1	CSL73	123,7	73,8	36,0	Pensile ROUND con 2 ante / ROUND hanging element with 2 doors
1	D152	261,0	46,2	59,0	Elemento terminale con mensole triangolari / End unit with triangular shelves
1	FN48	261,0	3,2	59,0	Fianco SYSTEM 32 / SYSTEM 32 Side
1	FN48	261,0	3,2	59,0	Fianco SYSTEM 32 / SYSTEM 32 Side
1	FN58	261,0	2,5	56,8	Divisore intermedio / Intermediate Partition
1	GSV33	7,3	200,0	4,0	Guida di scorrimento DRIVE in alluminio / DRIVE sliding rail in aluminium
1	LER04	112,9	140,0	210,6	Letto ROUND 1 piazza e mezzo con testata tipo A / ROUND 3/4 bed with headboard type A
2	PM67	110,0	0,8	4,0	Maniglia Side H. 1100 / Side handle H. 1100
2	PUF4	46,0	40,0	40,0	Pouf con ruote / Pouf with castors
1	TQA69	77,2	150,0	59,2	Scrivania spessore 4 cm scorrevole su guida con piede Square con ruote / Sliding desk thickness 4 cm with rail and Square foot with castors

INGOMBRI / DIMENSIONS

CONFIGURATION
345

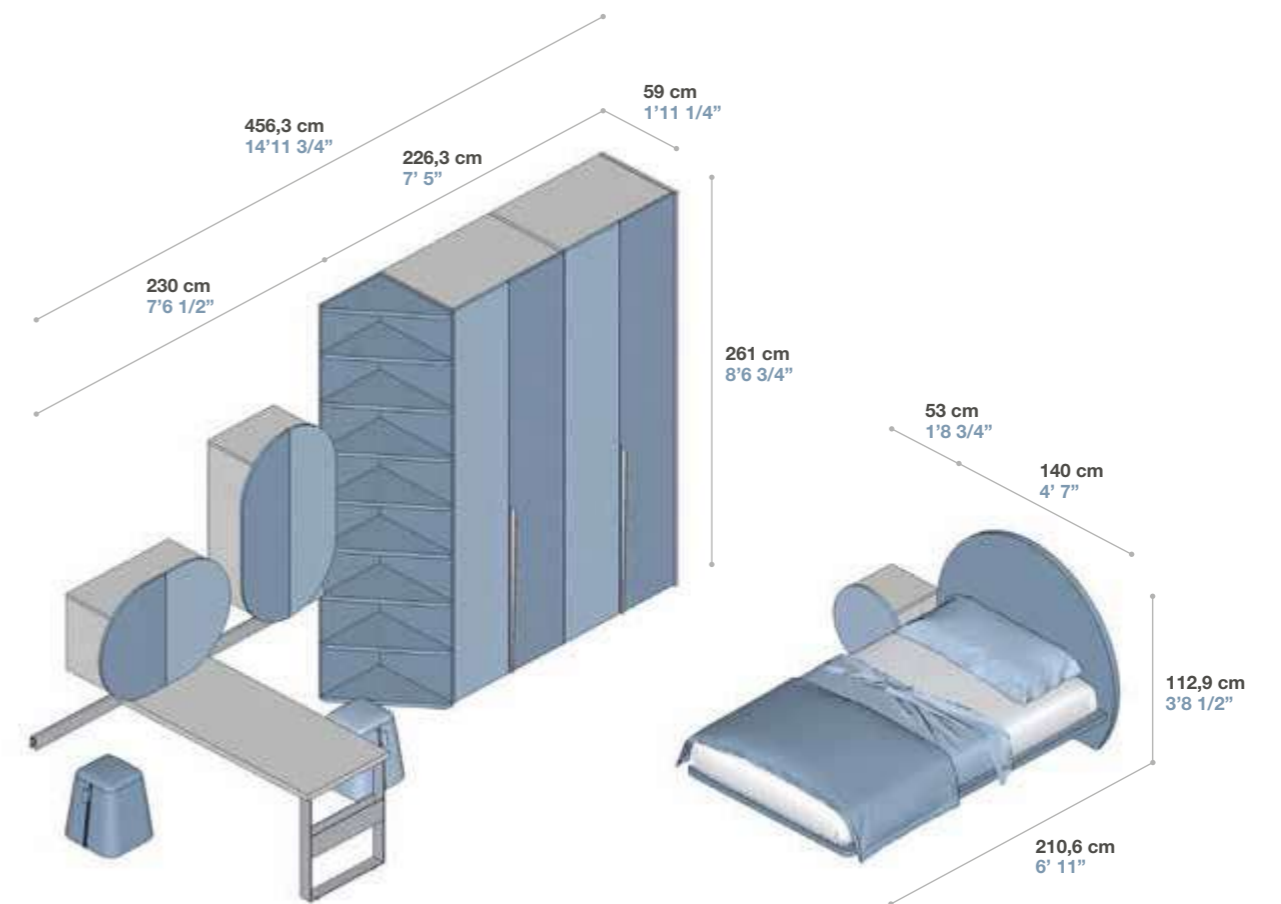

FINITURE / FINISHES



CONFIGURATION

346



Q.TA Q.TY	CODICE CODE	A / H	L / W	P / D	DESCRIZIONE / DESCRIPTION
2	B146	261,0	85,6	56,8	Colonna armadio 2 ante / Column wardrobe 2 doors
1	CSL71	73,8	73,8	36,0	Pensile ROUND con 1 anta / ROUND hanging element with 1 door
1	CSL71	73,8	73,8	36,0	Pensile ROUND con 1 anta / ROUND hanging element with 1 door
2	FN08	261,0	2,0	56,8	Fianco SYSTEM 20 / SYSTEM 20 Side
1	FN58	261,0	2,5	56,8	Divisore intermedio / Intermediate Partition
1	LER08	111,5	139,2	210,6	Letto ROUND 1 piazza e mezzo con testata tipo C / ROUND 3/4 bed with headboard type C
1	ME33	2,8	133,4	33,4	Mensola lineare con reggimensola a scomparsa / Linear shelf with concealed bracket
1	MGLCL2C	17,8	81,2	2,0	Maggiorazione laccatura frontale / Supplement for front part lacquering
2	MQ74	18,0	81,5	41,5	Comodino pensile con 1 cassetto / Wall night table with 1 drawer
2	PM62	259,1	20,0	2,0	Maniglia Code L. 200 per ante H. 2610 / Code handle W.200 for doors H. 2610
2	PM64	259,1	12,0	2,0	Maniglia Code L. 120 per ante H. 2610 / Code handle W.120 for doors H. 2610
1	PUF4	46,0	40,0	40,0	Pouf con ruote / Pouf with castors
1	TQ81	24,0	133,4	59,0	Scrivania pensile spessore 4 cm con fascia H.20 cm / Wall desk thickness 4 cm with strip H.20 cm

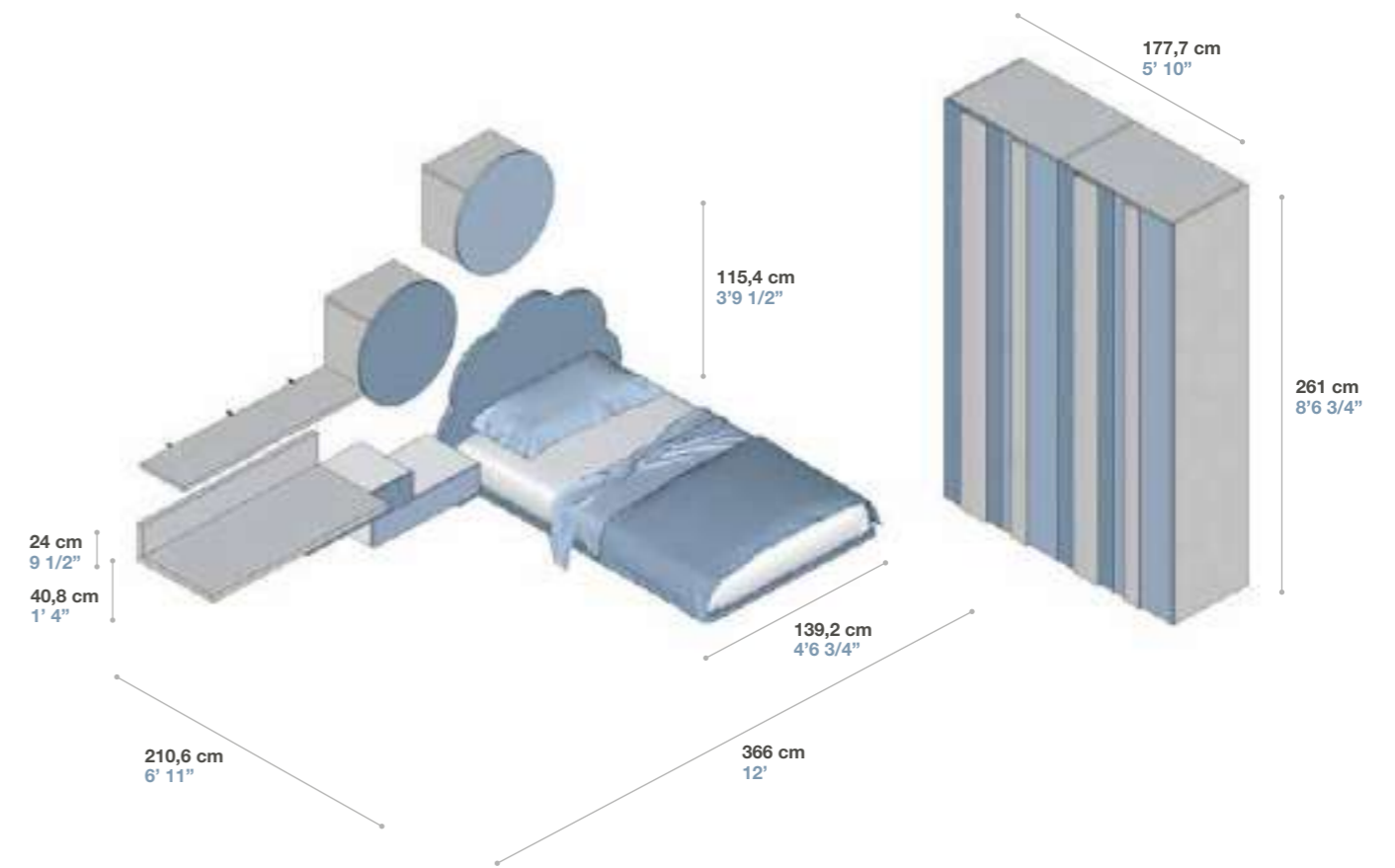

FINITURE / FINISHES







DESCRIZIONE TECNICA / TECHNICAL DATA

Q.TA Q.TY	CODICE CODE	A / H	L / W	P / D	DESCRIZIONE / DESCRIPTION
1	B134	261,0	41,6	56,8	Colonna armadio 1 anta / Column wardrobe 1 door
2	B146	261,0	85,6	56,8	Colonna armadio 2 ante / Column wardrobe 2 doors
2	CSL63	124,6	73,8	43,7	Cassettone ROUND con 4 cassetti / ROUND element with 4 drawers
2	FN08	261,0	2,0	56,8	Fianco SYSTEM 20 / SYSTEM 20 Side
2	FN58	261,0	2,5	56,8	Divisore intermedio / Intermediate Partition
1	LER32	115,4	132,6	214,6	Letto ROUND imbottito 1 piazza e mezzo con testata tipo B / ROUND upholstered 3/4 bed with headboard type B
1	MGCBIG	115,4	132,6	214,6	Maggiorazione cordoncino in rilievo per testate Round big / Supplement for relief piping on Round big headboards
1	MQ72	18,0	37,5	41,5	Comodino pensile con 1 cassetto / Hanging night table with 1 drawer
1	MQ74	18,0	81,5	41,5	Comodino pensile con 1 cassetto / Wall night table with 1 drawer
2	PM65	0,8	11,0	4,0	Maniglia Side H. 110 / Side handle H. 110
3	PM66	0,8	20,0	4,0	Maniglia Side H. 200 / Side handle H. 200
1	UV99	100,0	322,4	0,1	Stampa digitale su pannello con immagine archivio Tumidei o cliente / Digital print on panel with image from Tumidei' library or from customer
3	VS25	20,0	56,5	20,5	Mensola T-BOX L 56.5 cm / T-BOX shelf W 56.5 cm
3	VS26	20,0	100,0	20,5	Mensola T-BOX L 100 cm / T-BOX shelf W 100 cm

INGOMBRI / DIMENSIONS

CONFIGURATION
347

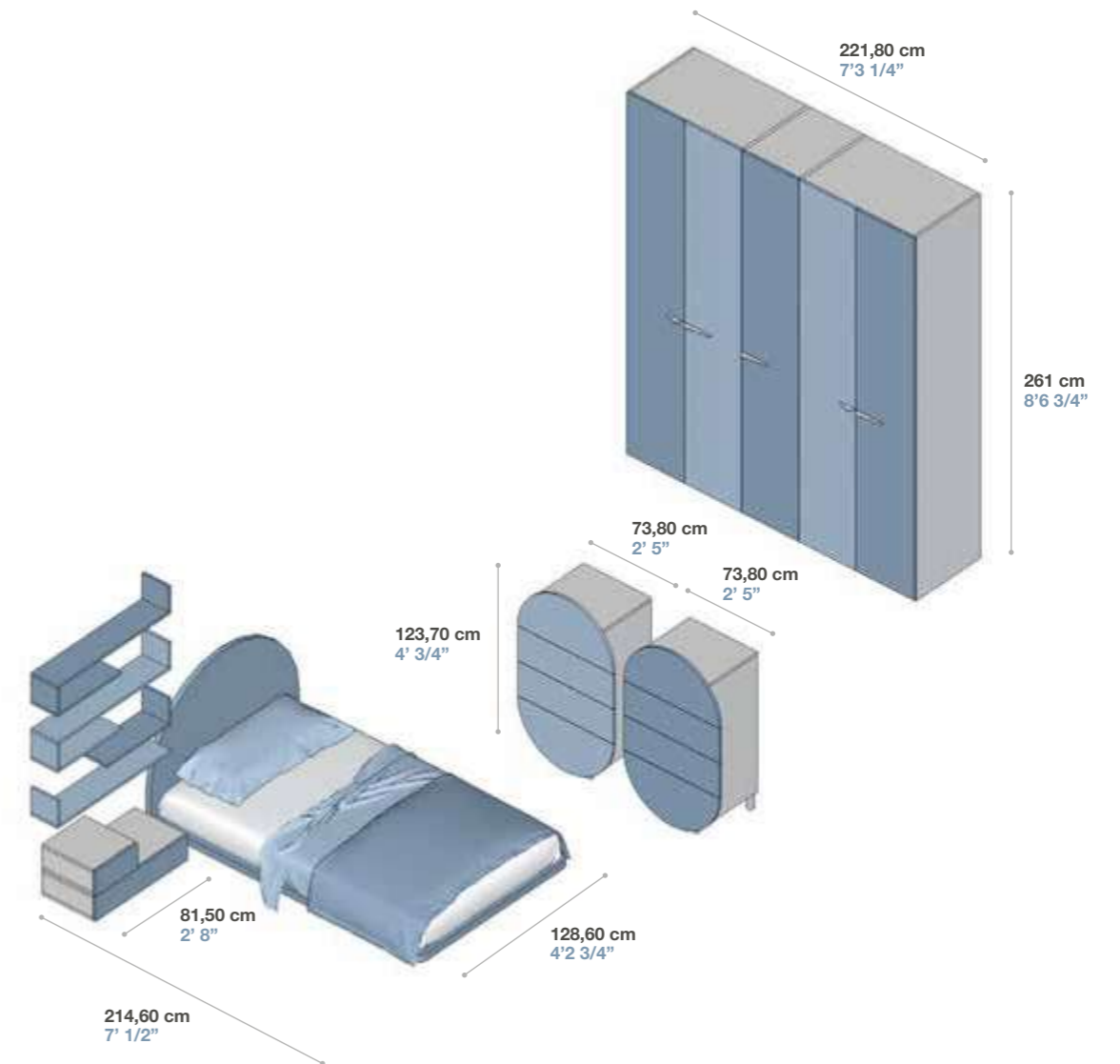

FINITURE / FINISHES

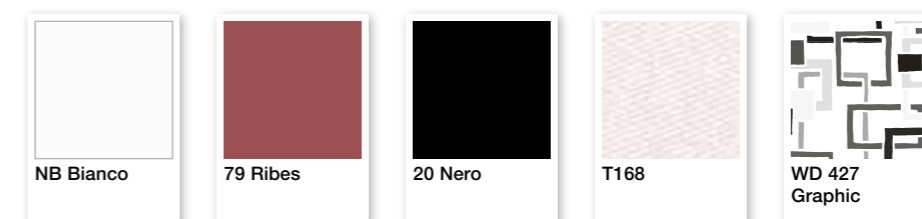

#DESIGNER BOY

EASY
Easy system







Configuration 348

Libreria in "Folding" con piano scrittoio.
"Folding" bookcase with writing desk.



Q.TA Q.TY	CODICE CODE	A / H	L / W	P / D	DESCRIZIONE / DESCRIPTION
2	AR08	261,0	2,8	56,8	Fianco di chiusura / Closing Side
1	AR36	263,0	261,8	56,8	Armadio 3 ante scorrevoli / Wardrobe 3 sliding doors
2	FK36	197,0	7,5	33,4	Fianco folding monofacciale / Monoface side in folding
1	L614	197,0	124,7	33,4	Colonna libreria in folding con 6 ripiani / Bookcase folding column with 6 shelves
1	L699	197,0	66,3	33,4	Colonna libreria in folding con 6 ripiani / Bookcase folding column with 6 shelves
1	LD70X	99,0	173,6	223,9	Letto EVO matrimoniale imbottito con testata imbottita / EVO upholstered double bed with headboard
2	MQ73	18,0	52,3	41,5	Comodino pensile con 1 cassetto / Hanging night table with 1 drawer
2	PG31	7,5	137,6	33,4	Mensola folding / Folding shelves
1	SE76	85,5	65,0	65,0	Sedia con ruote regolabile in altezza con scocca in legno schienale in tessuto e base in metallo / Chair on castors adjustable in height with wooden structure, back in fabric and metal base
1	SE79	85,5	65,0	65,0	Seduta imbottita sfoderabile per SE72 e SE76 / Upholstered and removable seat for SE72 and SE76
1	TC02	130,0	130,0	27,5	Elemento pensile T-CLOUD con 8 vani a giorno / T-CLOUD wall box with 8 open sections
2	TC07	29,4	29,4	1,2	Copri diffusore / Loudspeaker cover
1	XY14	7,5	137,6	46,2	Piano folding uso scrittoio / Folding top for desk

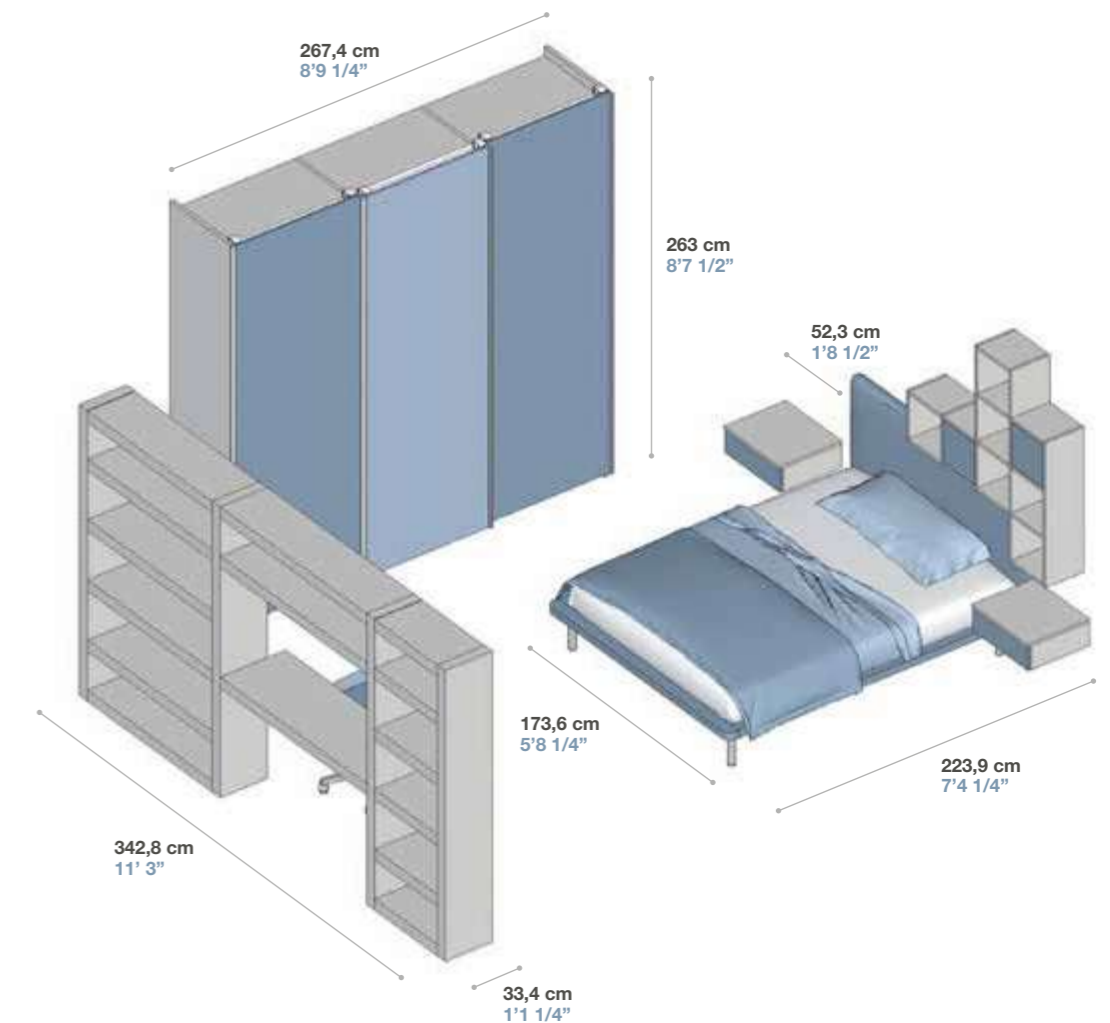

FINITURE / FINISHES

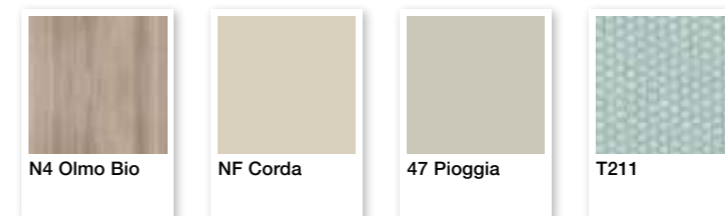

CONFIGURATION
349



DESCRIZIONE TECNICA / TECHNICAL DATA

Q.TA Q.TY	CODICE CODE	A / H	L / W	P / D	DESCRIZIONE / DESCRIPTION
2	B134	261,0	41,6	56,8	Colonna armadio 1 anta / Column wardrobe 1 door
1	FF37	229,0	2,8	33,4	Fianco SYSTEM 28 / SYSTEM 28 Side
2	FN08	261,0	2,0	56,8	Fianco SYSTEM 20 / SYSTEM 20 Side
2	FN78	261,0	1,2	56,8	Fianco spessore 1,2 cm / Side thickness 1,2 cm
1	GEA02N	261,0	120,9	120,9	Cabina armadio ad angolo tipo A con ante battenti / Corner closet Type A with hinged doors
1	GR23	73,2	4,0	59,0	Gamba telaio in metallo / Frame leg in metal
1	LH12X	93,0	127,0	208,6	Letto SYSTEM STAR 1 piazza e mezza fisso con testata H.78.5 cm / SYSTEM STAR 3/4 fixed bed with headboard H.78.5 cm
1	MJB938	4,0	150,0	80,0	Piano sagomato sp.4 cm / Shaped top th.4 cm
2	ML95	40,8	74,0	31,1	Contenitore pensile in metallo con 2 vani / Wall metal box with 2 sections
1	MQ59	110,0	40,8	31,1	Elemento pensile verticale con 3 vani a giorno / Vertical wall box with 3 open sections
1	MQ6C	74,0	40,8	31,1	Elemento pensile verticale con 2 vani a giorno e 1 anta doppia / Vertical wall box with 2 open sections e 1 double door
4	PX79	10,0	18,0	3,2	Maniglia rettangolare con stampa digitale / Rectangular handle with digital print
1	SE72	90,5	65,0	65,0	Sedia con ruote e regolabile in altezza con scocca in legno e basamento in metallo / Chair on castors adjustable in height with wooden structure and metal base
1	SE79	90,5	65,0	65,0	Seduta imbottita sfoderabile per SE72 e SE76 / Upholstered and removable seat for SE72 and SE76
1	T195	229,0	46,8	33,4	Colonna libreria SYSTEM 28 / Bookcase column SYSTEM 28
1	TC01	98,0	66,0	27,5	Elemento pensile T-CLOUD con 4 vani a giorno / T-CLOUD wall box with 4 open sections
1	TC01	66,0	98,0	27,5	Elemento pensile T-CLOUD con 4 vani a giorno / T-CLOUD wall box with 4 open sections
1	UV99	100,0	464,6	0,1	Stampa digitale su pannello con immagine archivio Tumidei o cliente / Digital print on panel with image from Tumidei' library or from customer

INGOMBRI / DIMENSIONS

CONFIGURATION
349

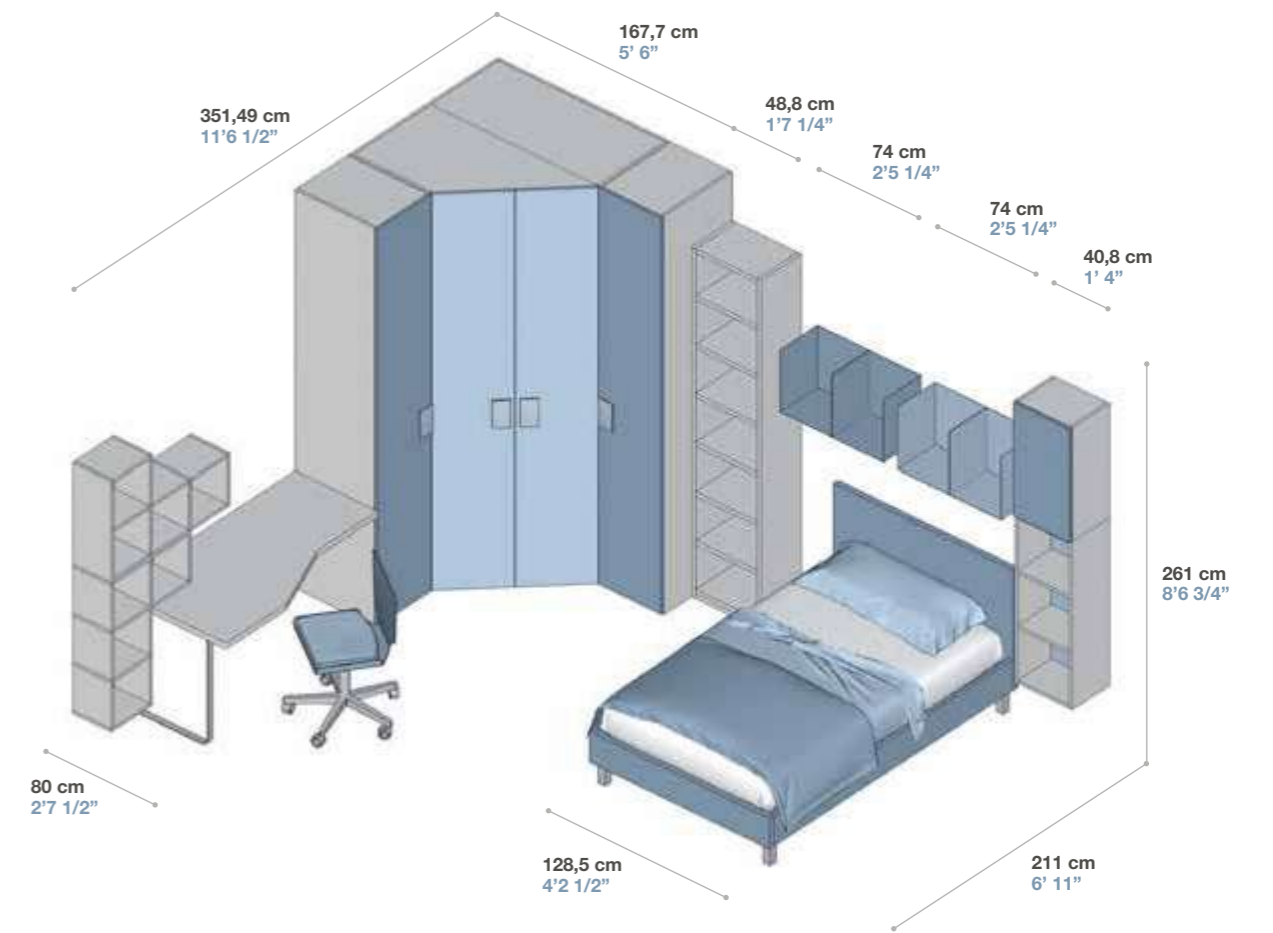

FINITURE / FINISHES

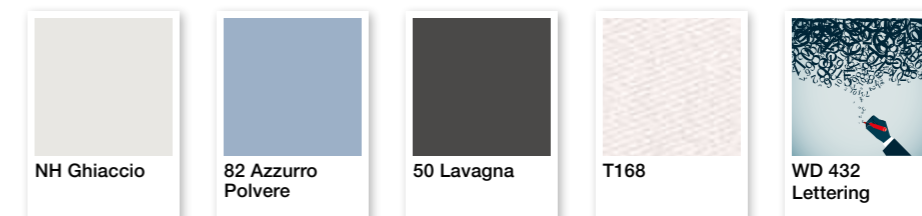

CONFIGURATION
350







DESCRIZIONE TECNICA / TECHNICAL DATA

Q.TA Q.TY	CODICE CODE	A / H	L / W	P / D	DESCRIZIONE / DESCRIPTION
2	B146	261,0	85,6	56,8	Colonna armadio 2 ante / Column wardrobe 2 doors
2	BF45	165,0	100,0	2,5	Boiserie SPAZIO5 / SPAZIO5 wall panels
2	FN08	261,0	2,0	56,8	Fianco SYSTEM 20 / SYSTEM 20 Side
1	FN58	261,0	2,5	56,8	Divisore intermedio / Intermediate Partition
1	LX01	84,2	107,6	203,0	Letto TEO singolo con rete a doghe, piedi torniti in frassino naturale e testata bassa / TEO single bed with slatted base, turned legs in natural ash and low headboard
1	MGATQA	6,5	4,0	59,0	Maggiorazione per fascia di appoggio / Supplement for supporting strip
2	MGT56	164,6	100,0	2,5	Maggiorazione per coppia di livellatori / Supplement for couple of level adjusters
1	MQ73	18,0	52,3	41,5	Comodino pensile con 1 cassetto / Hanging night table with 1 drawer
1	MQA65	66,7	82,3	31,1	Elemento multivano a terra con 3 vani a giorno e 1 anta / Floor multi-sections cabinet with 3 open sections and 1 door
1	MQA66	66,7	82,3	31,1	Elemento multivano a terra con 3 vani a giorno e 1 anta / Floor multi-sections cabinet with 3 open sections and 1 door
1	MQA71	82,7	66,3	31,1	Elemento multivano a terra con 3 vani a giorno e 1 anta / Floor multi-sections cabinet with 3 open sections and 1 door
1	MQA91	82,3	66,3	31,1	Elemento multivano pensile con 3 vani a giorno e 1 anta / Wall multi-sections cabinet with 3 open sections and 1 door
2	PX35L	8,0	8,0	4,7	Pomolo ovale in frassino laccato / Oval knob in lacquered ash
2	PX36L	11,0	11,0	4,7	Pomolo ovale in frassino laccato / Oval knob in lacquered ash
1	SE10	97,0	65,0	65,0	Sedia con ruote e regolabile in altezza con scocca imbottita sfoderabile e basamento in metallo / Chair on castors adjustable in height with upholstered and removable structure and metal base
1	TE28	84,2	107,6	203,0	Formella imbottita per testata / Upholstered shape for headboard
1	TQA11	77,2	150,0	59,0	Scrivania sp. 4 cm per aggancio a muro o pannello con 1 coppia di gambe tornite in frassino / Desk th. 4 cm for wall or panel fixing with 1 couple of turned legs in ash

INGOMBRI / DIMENSIONS

CONFIGURATION

350

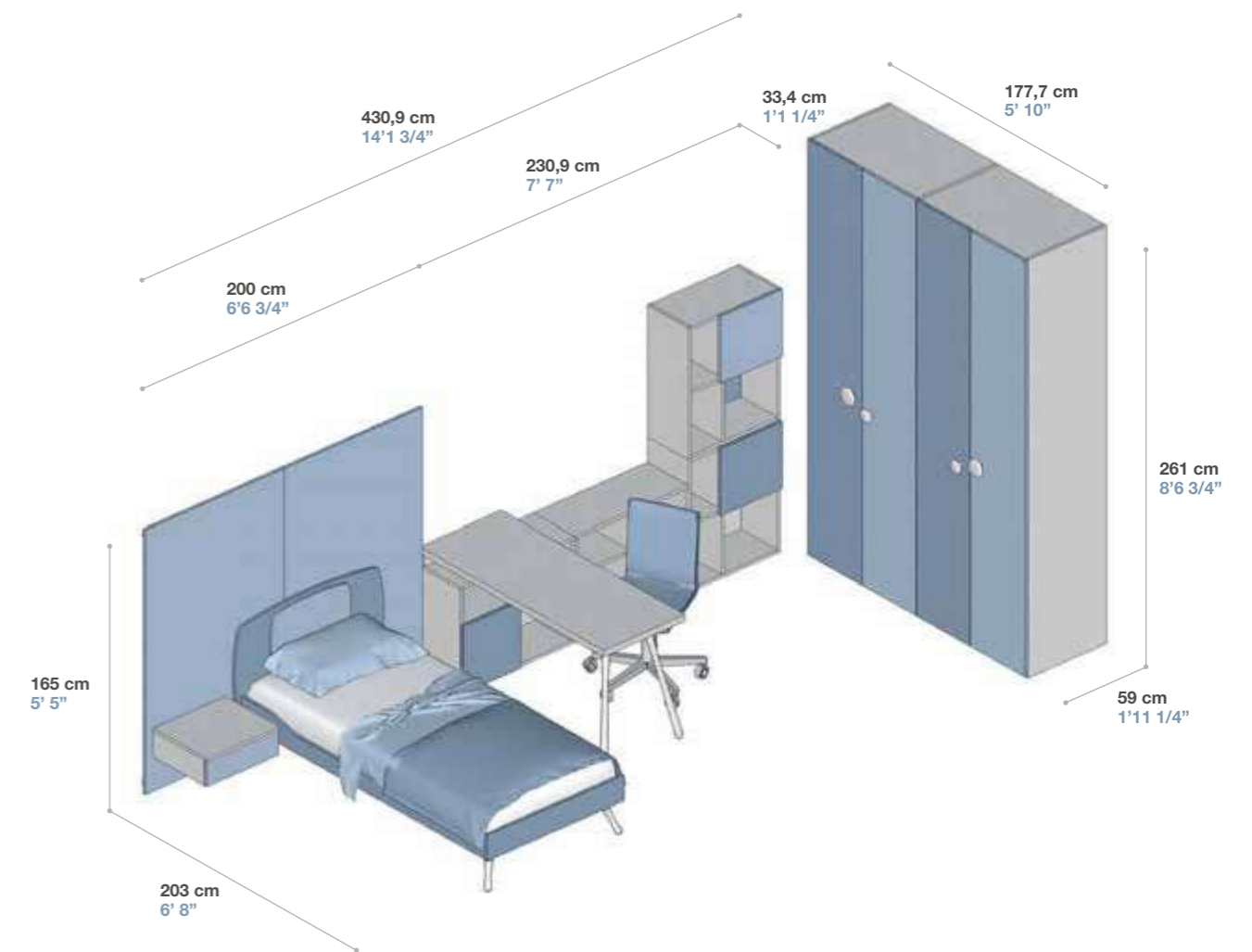

FINITURE / FINISHES



CONFIGURATION
351





Q.TA Q.TY	CODICE CODE	A / H	L / W	P / D	DESCRIZIONE / DESCRIPTION
2	B146	261,0	85,6	56,8	Colonna armadio 2 ante / Column wardrobe 2 doors
1	CSL36	50,0	37,5	43,7	Comodino con ruote con 1 cassetto e 1 cassettone / Night table on castors with 1 drawer and 1 high drawer
1	FF34	133,0	2,8	33,4	Fianco SYSTEM 28 / SYSTEM 28 Side
2	FN48	261,0	3,2	59,0	Fianco SYSTEM 32 / SYSTEM 32 Side
1	FN58	261,0	2,5	56,8	Divisore intermedio / Intermediate Partition
1	LX02	104,2	98,6	203,0	Letto TEO singolo con rete a doghe, piedi torniti in frassino naturale e testata bassa / TEO single bed with slatted base, turned legs in natural ash and low headboard
4	ML84	24,0	50,0	25,0	Mensola in metallo con fianchi e schiena in legno spessore 2 cm / Metal shelf with sides and wooden back thickness 2 cm
3	PX35L	8,0	8,0	4,7	Pomolo ovale in frassino laccato / Oval knob in lacquered ash
2	PX36L	11,0	11,0	4,7	Pomolo ovale in frassino laccato / Oval knob in lacquered ash
1	SE10	97,0	65,0	65,0	Sedia con ruote e regolabile in altezza con scocca imbottita sfoderabile e basamento in metallo / Chair on castors adjustable in height with upholstered and removable structure and metal base
1	T511	133,0	61,6	33,4	Colonna libreria SYSTEM 28 da comp. 351 / Bookcase column SYSTEM 28 from comp. 351
1	T512	133,0	61,6	33,4	Colonna libreria SYSTEM 28 da comp. 351 / Bookcase column SYSTEM 28 from comp. 351
1	T513	133,0	61,6	33,4	Colonna libreria SYSTEM 28 da comp. 351 / Bookcase column SYSTEM 28 from comp. 351
1	TE28	104,2	98,6	203,0	Formella imbottita per testata / Upholstered shape for headboard
1	TQA14	77,2	140,0	70,0	Scrivania spessore 4 cm con gambe tornite in frassino / Desk thickness 4 cm with turned legs in ash

351

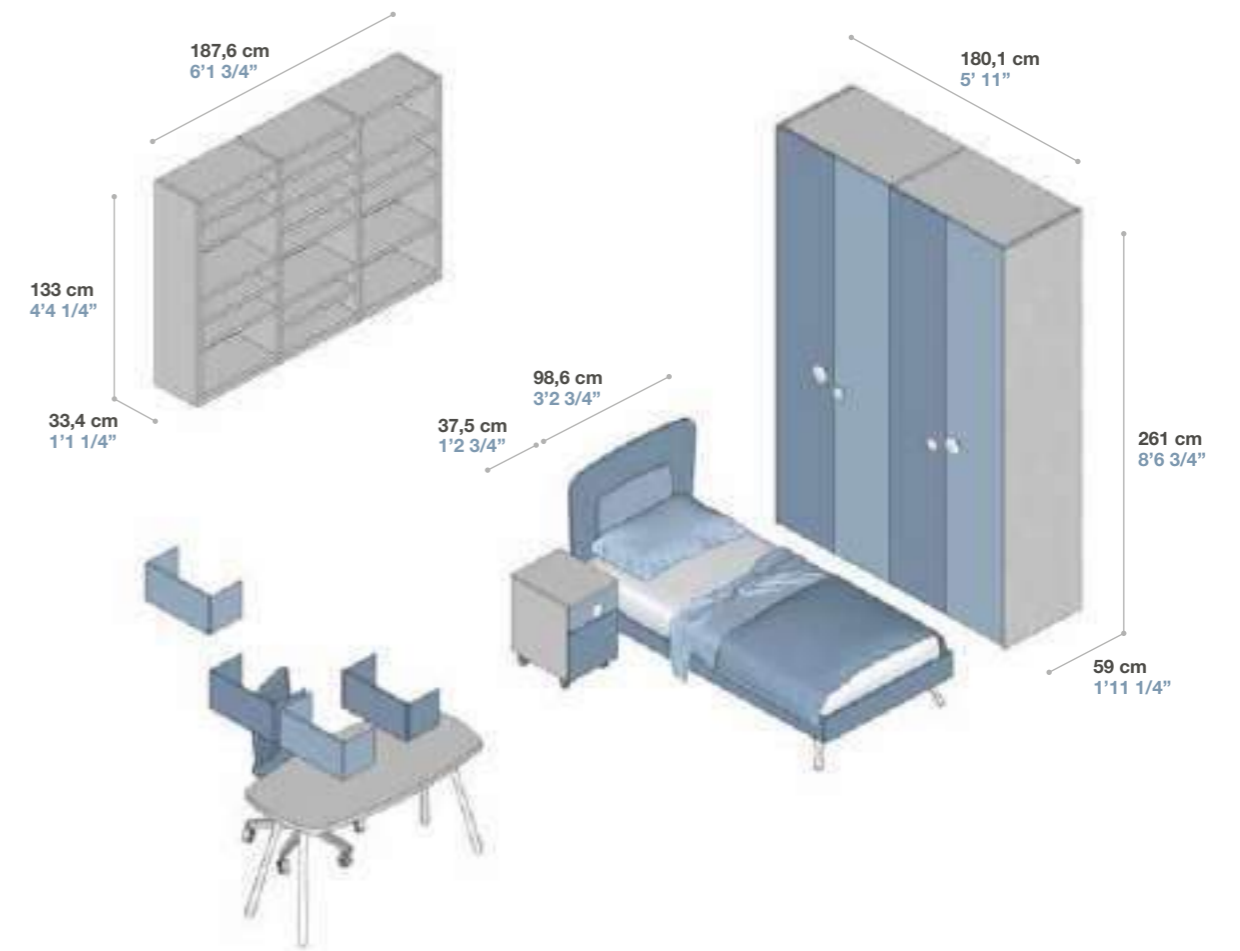

FINITURE / FINISHES



N3 Olmo Calce



N4 Olmo Bio

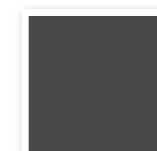

50 Lavagna

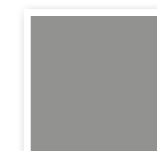

81 Grigio Fumè

T245
Fantasia
/ PatternedWD 440
Street

CONFIGURATION
352



Q.TA Q.TY	CODICE CODE	A / H	L / W	P / D	DESCRIZIONE / DESCRIPTION
1	AR08	261,0	2,8	56,8	Fianco di chiusura / Closing Side
1	AR08	261,0	2,8	60,5	Fianco di chiusura / Closing Side
1	AR37	263,0	232,9	56,8	Armadio 2 ante scorrevoli / Wardrobe 2 sliding doors
1	LD72X	99,0	133,6	223,9	Letto EVO 1 piazza e mezzo imbottito con testata imbottita / EVO upholstered 3/4 bed with headboard
1	MGLMQ5T	36,8	106,0	2,0	Maggiorazione laccatura schiena / Supplement for lacquered back
1	ML86	40,8	37,0	25,0	Mensola in metallo con fianchi e schiena in legno / Metal shelf with sides and wooden back
3	ML95	40,8	74,0	31,1	Contenitore pensile in metallo con 2 vani / Wall metal box with 2 sections
1	MQ66A	40,8	74,0	31,1	Elemento pensile orizzontale con 2 vani a giorno e 1 anta doppia / Horizontal wall box with 2 open sections and 1 double door
1	MQA56	110,0	40,8	31,1	Elemento pensile verticale con 3 vani a giorno e 1 anta doppia / Vertical wall box with 3 open sections and 1 double door
1	SE76	85,5	65,0	65,0	Sedia con ruote regolabile in altezza con scocca in legno schienale in tessuto e base in metallo / Chair on castors adjustable in height with wooden structure, back in fabric and metal base
1	SE79	85,5	65,0	65,0	Seduta imbottita sfoderabile per SE72 e SE76 / Upholstered and removable seat for SE72 and SE76
1	TQ82	24,0	166,6	59,0	Scrivania pensile spessore 4 cm con fascia H.20 cm / Wall desk thickness 4 cm with strip H.20 cm

352

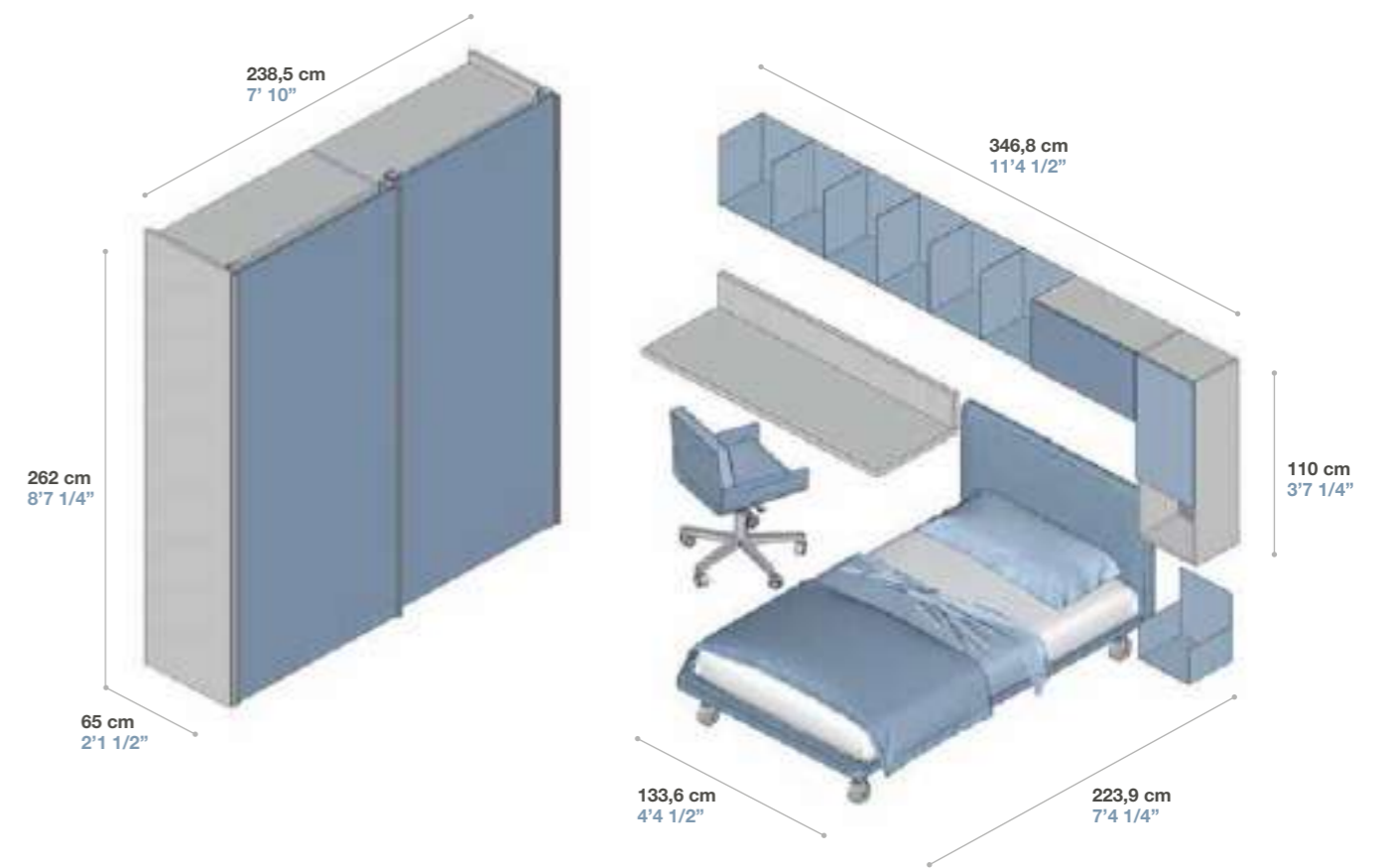

FINITURE / FINISHES

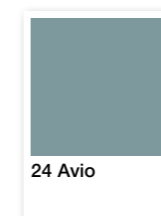

Configuration 353



#GRAPHIC STUDENTS

PONTI A SBALZO
Overhang bridges



CONFIGURATION

353





DESCRIZIONE TECNICA / TECHNICAL DATA

Q.TA Q.TY	CODICE CODE	A / H	L / W	P / D	DESCRIZIONE / DESCRIPTION
1	B197	261,0	41,6	56,8	Colonna armadio 1 anta 2 cassetti e 1 cassettono / Column wardrobe 1 door, 2 drawers and 1 high drawer
1	ET88	171,7	80,4	0,1	Adesivo removibile TIK STAK / removable sticker TIK STAK
2	FN08	261,0	2,0	56,8	Fianco SYSTEM 20 / SYSTEM 20 Side
1	LR36	62,1	95,0	203,5	Letto LORY singolo inferiore scorrevole su ruote con rete a doghe e 2 cassettoni / LORY lower single bed sliding on castors with slatted base and 2 drawers
1	P943N	261,0	304,0	87,6	Ponte SLIDE con letto a sbalzo estraibile ed elemento pensile con 2 ante battenti / SLIDE bridge with overhang pull-out bed and wall unit with 2 hinged doors
2	PX18	5,5	6,2	2,5	Maniglia triangolare / Triangular handle
1	PX19	5,0	5,0	2,7	Pomolo ovale / Oval Knobs
7	PX77	5,0	5,0	3,2	Maniglia quadrata / Square handle
2	PX78	10,0	18,0	3,2	Maniglia rettangolare / Rectangular handle
1	SCL04	132,6	41,4	87,6	Scala con 3 gradini e pannello / Stair with 3 steps and panel

INGOMBRI / DIMENSIONS

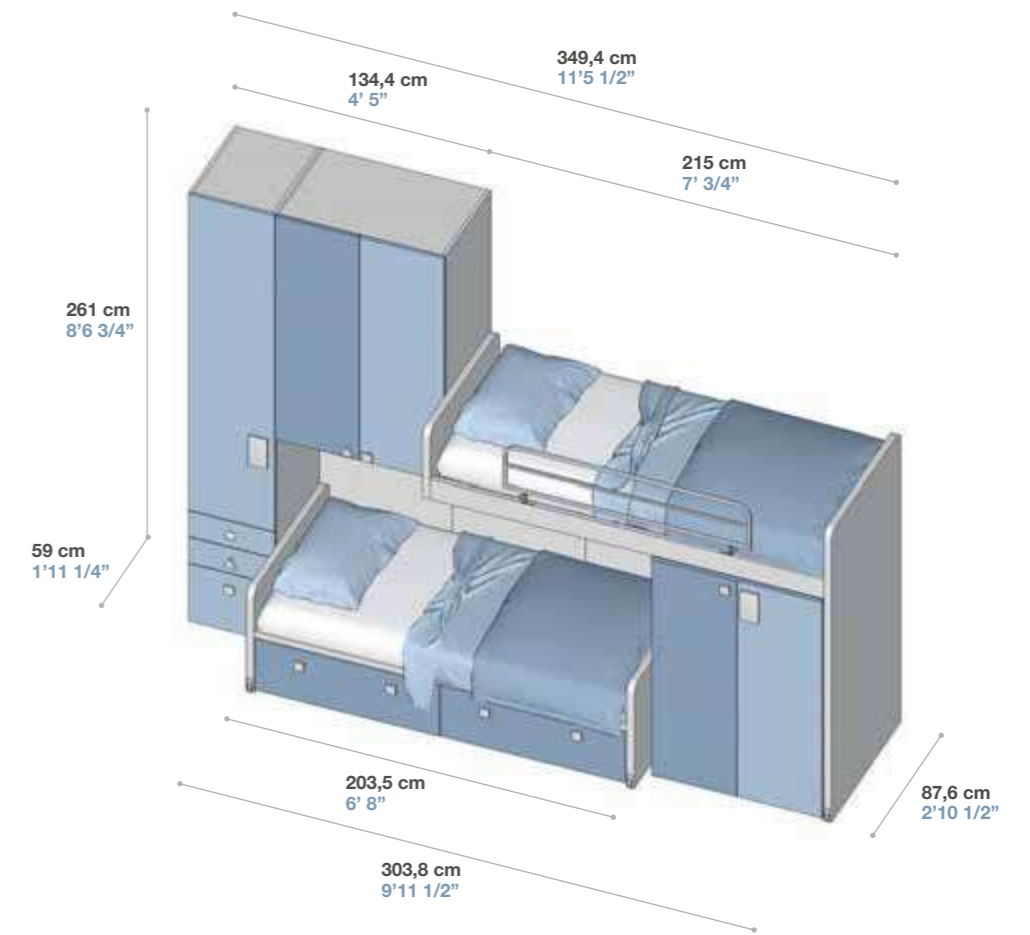
CONFIGURATION
353

FINITURE / FINISHES

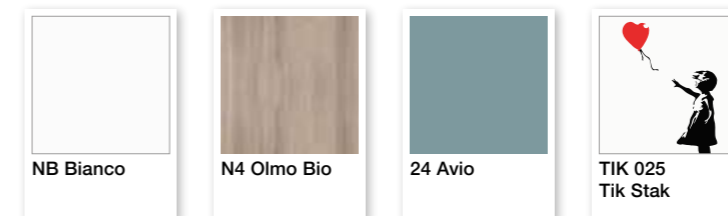





DESCRIZIONE TECNICA / TECHNICAL DATA

Q.TA Q.TY	CODICE CODE	A / H	L / W	P / D	DESCRIZIONE / DESCRIPTION
3	APP02	8,0	8,0	4,7	Pomolo appendiabiti / Coat hanger knob
1	D154	261,0	30,0	57,0	Elemento terminale con schiena / End unit with back
1	GEA10N	261,0	145,7	102,7	Cabina armadio ad angolo tipo C con ante battenti / Corner closet Type C with hinged doors
1	LR36	62,1	95,0	203,5	Letto LORY singolo inferiore scorrevole su ruote con rete a doghe e 2 cassettoni / LORY lower single bed sliding on castors with slatted base and 2 drawers
1	LR39	76,0	65,0	214,5	Scrivania scorrevole spessore 4 cm / Sliding desk thickness 4 cm
3	ME51	4,0	25,0	30,0	Mensola lineare per elemento terminale / Linear shelf for end unit
1	MF29	2,8	217,5	25,0	Mensola lineare con reggimensola a scomparsa / Linear shelf with concealed bracket
1	MGLAA54	131,1	51,8	2,0	Maggiorazione laccatura anta / Supplement for door lacquering
1	P939N	261,0	274,8	87,6	Ponte SLIDE con letto a sbalzo estraibile ed elemento pensile con 1 anta battente / SLIDE bridge with overhang pull-out bed and wall unit with 1 hinged door
4	PX35L	8,0	8,0	4,7	Pomolo ovale in frassino laccato / Oval knob in lacquered ash
1	PX36L	11,0	11,0	4,7	Pomolo ovale in frassino laccato / Oval knob in lacquered ash
1	SCL03	102,6	41,4	87,6	Scala con 3 gradini / Stair with 3 steps
1	TC72	73,8	42,0	45,5	Vaso Tetris con gambe in massello e impianto purificatore / Tetris vase with wooden legs and purifying system

INGOMBRI / DIMENSIONS

CONFIGURATION
354

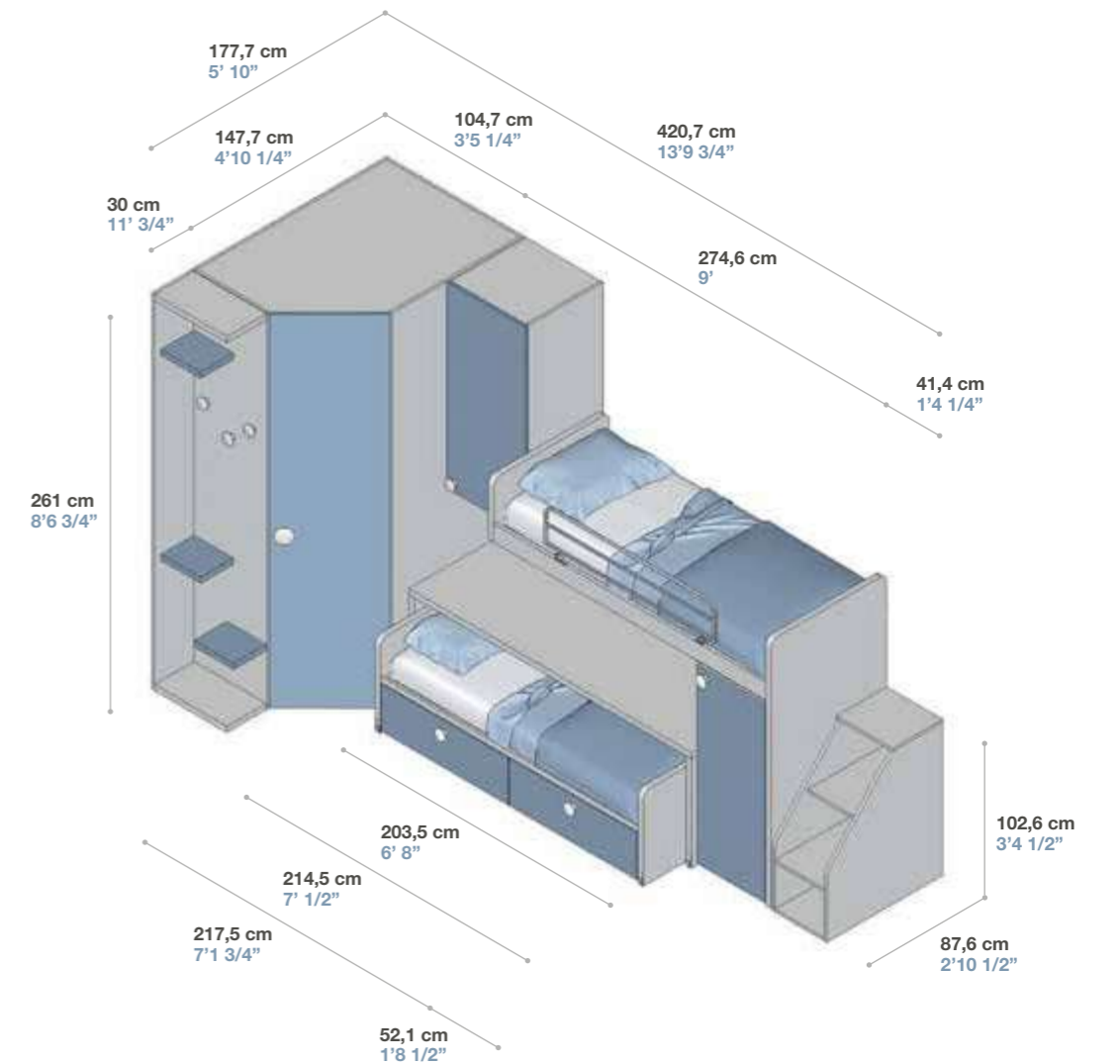

FINITURE / FINISHES



#STYLISH SISTERS

PONTI A SBALZO
Overhang bridges



Configuration 355

CONFIGURATION
355





SMART ITALIAN PROJECTS

Configuration 354



DESCRIZIONE TECNICA / TECHNICAL DATA

Q.TA Q.TY	CODICE CODE	A / H	L / W	P / D	DESCRIZIONE / DESCRIPTION
1	B139	261,0	41,6	56,8	Colonna armadio 1 anta e 4 cassetti / Column wardrobe 1 door and 4 drawers
1	BR15	2,5	85,6	31,0	Ripiano lineare / Linear shelf
1	ET88MIN	164,1	56,3	0,1	Adesivo removibile TIK STAK - Prezzo minimo a soggetto / removable sticker TIK STAK - Minimum price per subject
2	FN08	261,0	2,0	56,8	Fianco SYSTEM 20 / SYSTEM 20 Side
1	LR36	62,1	95,0	203,5	Letto LORY singolo inferiore scorrevole su ruote con rete a doghe e 2 cassettoni / LORY lower single bed sliding on castors with slatted base and 2 drawers
1	P937N	261,0	304,0	87,6	Ponte SLIDE con letto a sbalzo estraibile ed elemento pensile con 2 ante battenti / SLIDE bridge with overhang pull-out bed and wall unit with 2 hinged doors
1	PX18	5,5	6,2	2,5	Maniglia triangolare / Triangular handle
1	PX19	5,0	5,0	2,7	Pomolo ovale / Oval Knobs
1	PX71	7,0	7,0	2,0	Maniglia a forma T / T-shaped handle
8	PX77	5,0	5,0	3,2	Maniglia quadrata / Square handle
2	PX78	10,0	18,0	3,2	Maniglia rettangolare / Rectangular handle
1	SCL01	68,4	41,4	76,2	Scala con 2 gradini / Stair with 2 steps
2	VS24	20,0	43,5	20,5	Mensola T-BOX L 43.5 cm / T-BOX shelf W 43.5 cm

INGOMBRI / DIMENSIONS

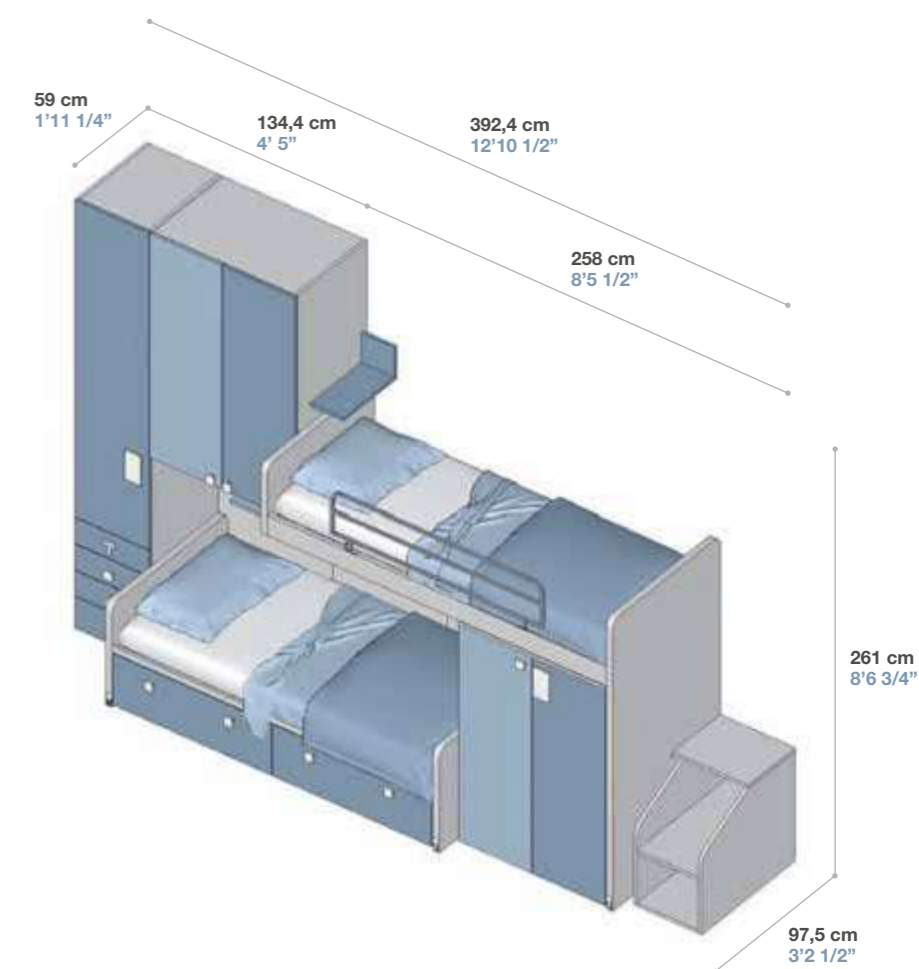
CONFIGURATION
355

FINITURE / FINISHES

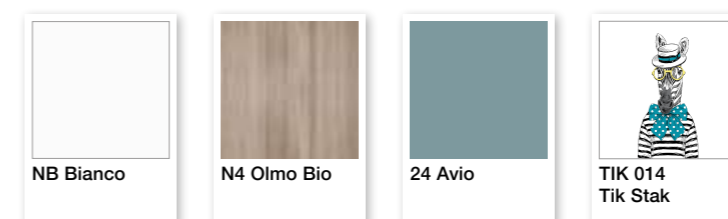

CONFIGURATION
356





Configuration 356

DESCRIZIONE TECNICA / TECHNICAL DATA

Q.TA Q.TY	CODICE CODE	A / H	L / W	P / D	DESCRIZIONE / DESCRIPTION
1	B146	261,0	85,6	56,8	Colonna armadio 2 ante / Column wardrobe 2 doors
2	FN08	261,0	2,0	56,8	Fianco SYSTEM 20 / SYSTEM 20 Side
1	LR36	62,1	95,0	203,5	Letto LORY singolo inferiore scorrevole su ruote con rete a doghe e 2 cassettoni / LORY lower single bed sliding on castors with slatted base and 2 drawers
1	MF29	2,8	209,0	25,0	Mensola lineare con reggimensola a scomparsa / Linear shelf with concealed bracket
1	MGLLR36	0,0	0,0	0,0	Maggiorazione laccatura coppia cassetti letto / Supplement for couple of bed drawers in lacquered
1	MGLSCL02	68,4	41,4	59,0	Maggiorazione laccatura cassetto / Supplement for laquered drawer
1	P935N	261,0	260,0	87,6	Ponte SLIDE con letto a sbalzo estraibile ed elemento pensile con 1 anta battente / SLIDE bridge with overhang pull-out bed and wall unit with 1 hinged door
6	PX35L	8,0	8,0	4,7	Pomolo ovale in frassino laccato / Oval knob in lacquered ash
1	PX36L	11,0	11,0	4,7	Pomolo ovale in frassino laccato / Oval knob in lacquered ash
1	SCL02	68,4	41,4	59,0	Scala con 2 gradini e 1 cassetto / Stair with 2 steps and 1 drawer
1	VS24	20,0	43,5	20,5	Mensola T-BOX L 43.5 cm / T-BOX shelf W 43.5 cm

INGOMBRI / DIMENSIONS

CONFIGURATION

356

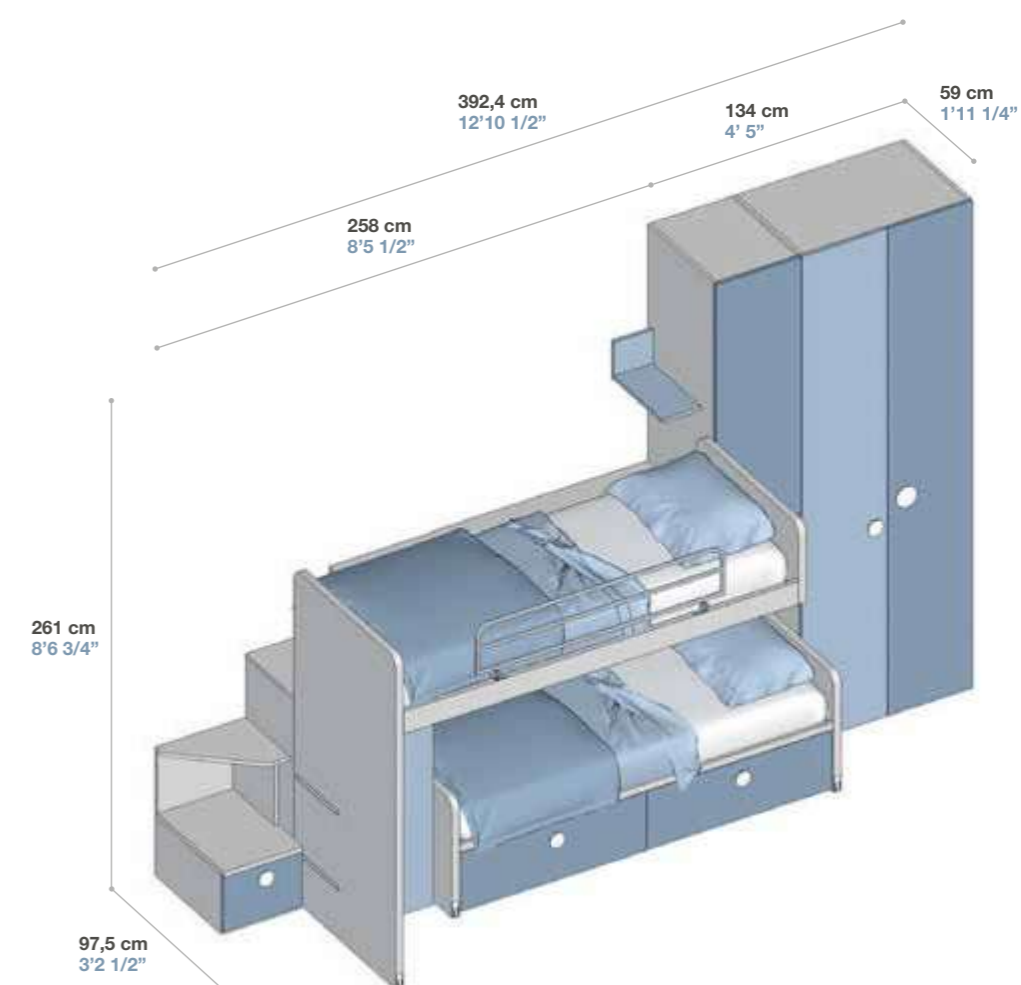

FINITURE / FINISHES

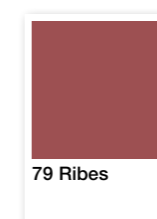
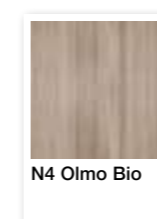
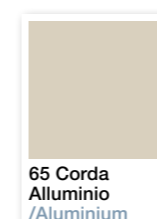

CONFIGURATION
357







Q.TA Q.TY	CODICE CODE	A / H	L / W	P / D	DESCRIZIONE / DESCRIPTION
1	B196	261,0	56,4	56,8	Colonna armadio 1 anta 2 cassetti e 1 cassettone / Column wardrobe with 1 door, 2 drawers and 1 high drawer
1	ET88	167,1	71,1	0,1	Adesivo removibile TIK STAK / removable sticker TIK STAK
2	FN48	261,0	3,2	59,0	Fianco SYSTEM 32 / SYSTEM 32 Side
1	LX40X	75,0	99,5	223,0	Letto SYSTEM SCRIGNO singolo imbottito fisso con testata e pediera H.75 cm e spessore 10 cm / SYSTEM SCRIGNO upholstered single fixed bed with headboard and footboard H.75 cm th.10 cm
1	P964N	261,0	266,4	217,6	Ponte SLIDE con letto scorrevole ed elemento pensile con 2 ante battenti / SLIDE bridge with sliding bed and wall unit with 2 hinged doors
6	PM42	1,5	33,8	3,5	Maniglia rettangolare / Rectangular handle
1	SCL05	133,0	178,6	41,4	Scala laterale con vani libreria / Lateral stairs with open sections
2	VS24	20,0	43,5	20,5	Mensola T-BOX L 43.5 cm / T-BOX shelf W 43.5 cm

357

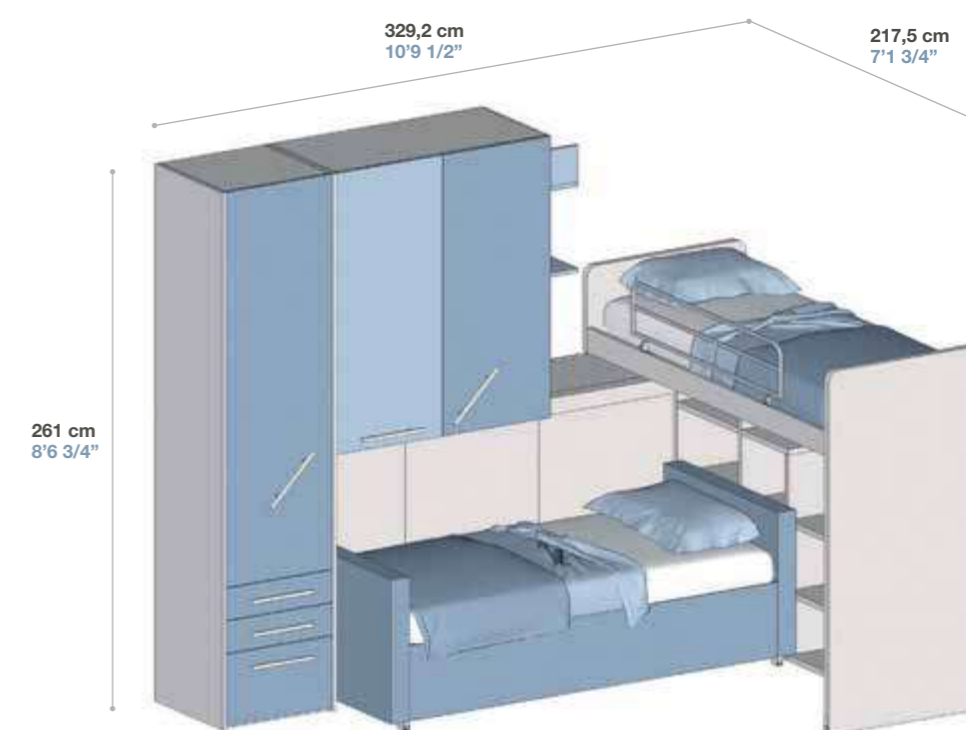

FINITURE / FINISHES



N3 Olmo Calce

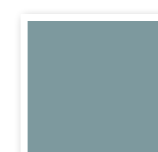

24 Avio

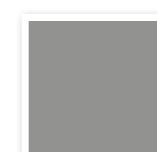

81 Grigio Fumè



T126

TIK 037
Tik Stak

#HIPSTER GUY

LETTI A RIBALTA
Foldaway beds



Configuration 358

CONFIGURATION
358



DESCRIZIONE TECNICA / TECHNICAL DATA

Q.TA Q.TY	CODICE CODE	A / H	L / W	P / D	DESCRIZIONE / DESCRIPTION
1	DJ21	40,0	83,0	91,0	Pouf fisso con contenitore / Fixed pouff with storage
1	DJ29	54,0	20,0	87,0	Bracciolo largo con tavolino estraibile e orientabile in nobilitato / Large armrest with lift-up tablet in melamine
1	DJ36	76,0	169,0	91,0	Divano 2 posti con movimento manuale / 2 seater sofa with manual recliner
2	FR77	229,0	4,0	33,4	Fianco finale sp. 4 cm per contenitore BLOCK / End side th. 4 cm for BLOCK cabinet
1	GSV34	7,3	220,0	4,0	Guida di scorrimento DRIVE in alluminio / DRIVE sliding rail in aluminium
1	LR94S	229,0	169,6	33,4	Contenitore BLOCK verticale senza fianchi con letto matrimoniale / Vertical BLOCK cabinet without sides with double bed
2	MGLAMQ63A	40,4	37,6	2,0	Maggiorazione laccatura anta / Supplement for door lacquering
1	MGLMQ5T	36,8	106,0	2,0	Maggiorazione laccatura schiena / Supplement for lacquered back
2	ML87	40,8	50,0	25,0	Mensola in metallo con fianchi e schiena in legno spessore 2 cm / Metal shelf with sides and wooden back thickness 2 cm
1	MQ57	40,8	110,0	31,1	Elemento pensile orizzontale con 3 vani a giorno / Horizontal wall box with 3 open sections
2	MQA44	40,8	74,0	31,1	Elemento pensile orizzontale con 2 vani a giorno e 1 anta / Horizontal wall box with 2 open sections and 1 door
1	MQA47	40,8	110,0	31,1	Elemento pensile orizzontale con 3 vani a giorno e 1 anta doppia / Horizontal wall box with 3 open sections and 1 double door
1	MQA55	110,0	40,8	31,1	Elemento pensile verticale con 3 vani a giorno e 1 anta doppia / Vertical wall box with 3 open sections and 1 double door
1	MQA56	110,0	40,8	31,1	Elemento pensile verticale con 3 vani a giorno e 1 anta doppia / Vertical wall box with 3 open sections and 1 double door
1	TQ58	77,2	150,0	65,0	Scrivania spessore 4 cm scorrevole su guida / Sliding desk thickness 4 cm on rail
1	UV99	100,0	342,0	0,1	Stampa digitale su pannello con immagine archivio Tumidei o cliente / Digital print on panel with image from Tumidei' library or from customer

INGOMBRI / DIMENSIONS

CONFIGURATION
358

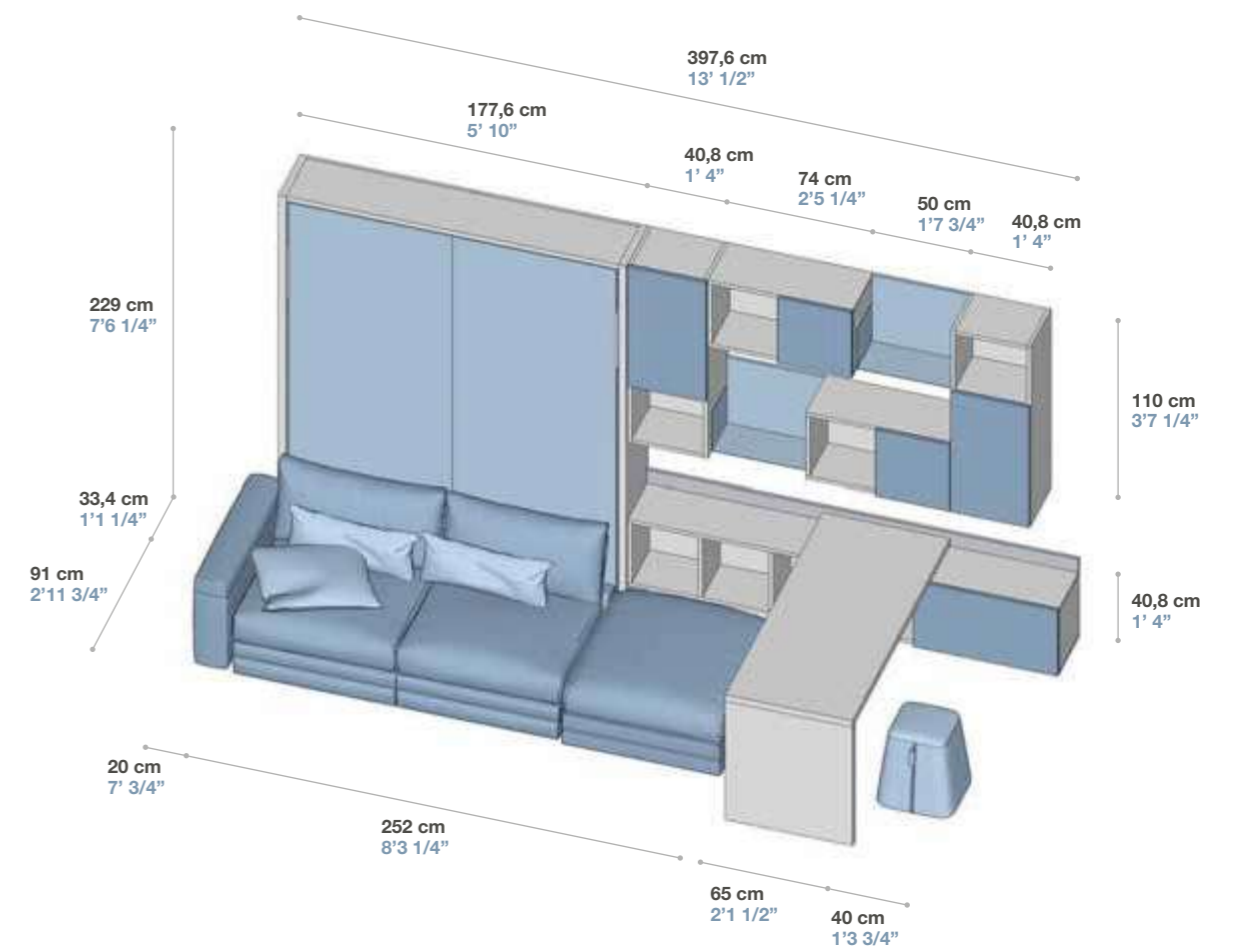

FINITURE / FINISHES





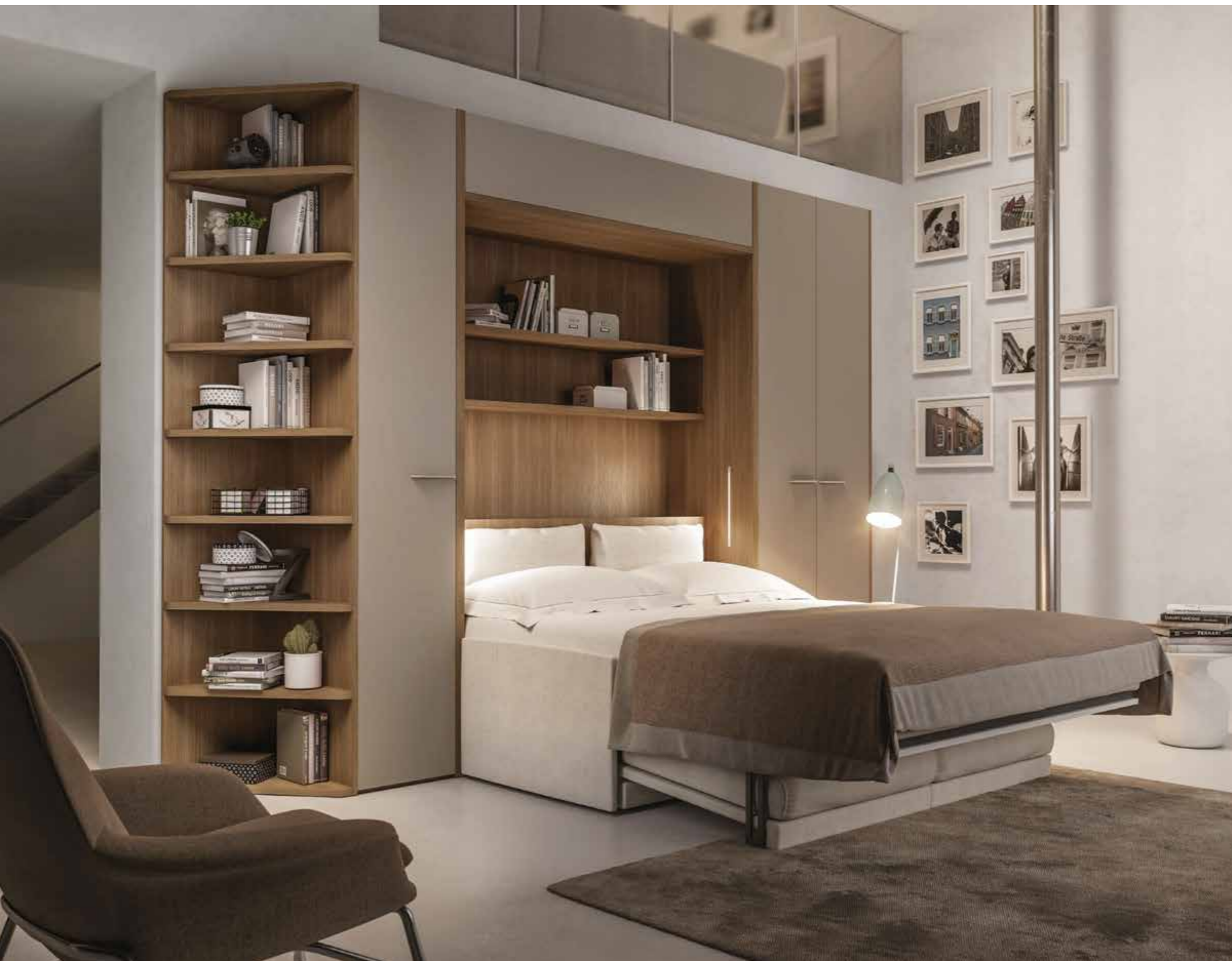

DESCRIZIONE TECNICA / TECHNICAL DATA

Q.TA Q.TY	CODICE CODE	A / H	L / W	P / D	DESCRIZIONE / DESCRIPTION
1	B134	261,0	41,6	56,8	Colonna armadio 1 anta / Column wardrobe 1 door
1	B146	261,0	85,6	56,8	Colonna armadio 2 ante / Column wardrobe 2 doors
1	D152	261,0	46,2	59,0	Elemento terminale con mensole triangolari / End unit with triangular shelves
2	DJ32	54,0	4,0	87,0	Bracciolo imbottito / Upholstered armrest
1	DJ36	76,0	169,0	91,0	Divano 2 posti con movimento manuale / 2 seater sofa with manual recliner
2	FN48	261,0	3,2	59,0	Fianco SYSTEM 32 / SYSTEM 32 Side
2	FN78	261,0	1,2	56,8	Fianco spessore 1,2 cm / Side thickness 1,2 cm
2	FR98	261,0	4,0	59,0	Fianco singolo sp. 40 per contenitore Block indipendente / Single Side th. 40 for self-standing Block cabinet
1	LR97S	261,0	169,6	59,0	Contenitore BLOCK verticale senza fianchi con letto matrimoniale e anta a ribalta superiore / Vertical BLOCK cabinet without sides with double bed and tilt door on top
2	LR98S	2,8	169,6	25,0	Ripiano per contenitore BLOCK matrimoniale profondità 59 cm / Shelf for double bed cabinet depth 59 cm
1	LRA14	63,8	169,6	27,5	Blocco testata imbottita e vano porta cuscino per contenitore prof. 59 cm / Set of upholstered headboard and storage space for pillow for cabinet depth 59 cm
3	PM66	0,8	20,0	4,0	Maniglia Side H. 200 / Side handle H. 200
1	UV99	100,0	369,2	0,1	Stampa digitale su pannello con immagine archivio Tumidei o cliente / Digital print on panel with image from Tumidei' library or from customer

INGOMBRI / DIMENSIONS

CONFIGURATION

359

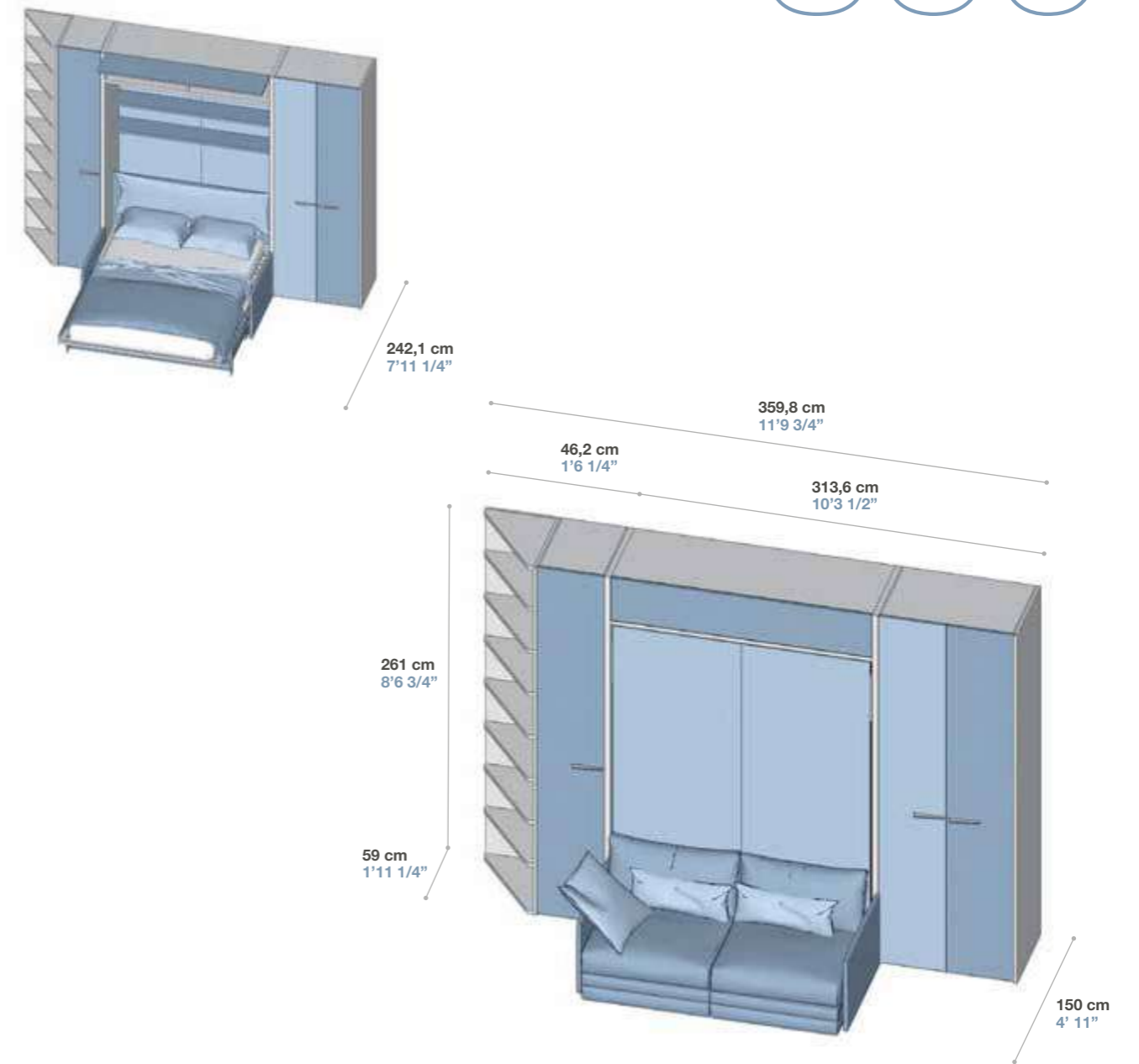

FINITURE / FINISHES

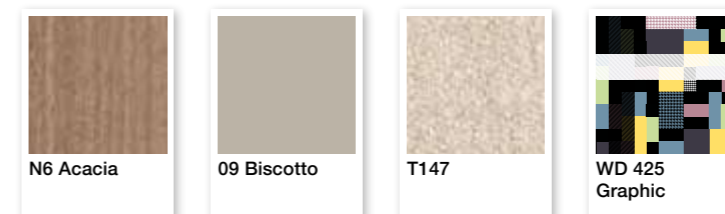



#YOUNG DREAMERS

LETTI A RIBALTA
Foldaway beds



CONFIGURATION
360





DESCRIZIONE TECNICA / TECHNICAL DATA

Q.TA Q.TY	CODICE CODE	A / H	L / W	P / D	DESCRIZIONE / DESCRIPTION
2	B134	261,0	41,6	56,8	Colonna armadio 1 anta / Column wardrobe 1 door
1	B183	101,0	56,4	56,8	Colonna armadio 2 cassetti e 2 cassettoni / Column wardrobe with 2 doors and 2 high drawers
1	B209	101,0	56,4	56,8	Colonna armadio 1 anta / Column wardrobe with 1 door
1	DJ44	33,0	122,0	82,0	Pouf grande indipendente / Self-standing big pouf
1	EZ21	1,4	1,4	14,5	Reggimensola a scomparsa con foratura / Concealed bracket for shelf with drilling
4	FN43	101,0	3,2	59,0	Fianco finale SYSTEM 32 / End side SYSTEM 32
3	FN48	261,0	3,2	59,0	Fianco SYSTEM 32 / SYSTEM 32 Side
1	FN58	261,0	2,5	56,8	Divisore intermedio / Intermediate Partition
1	KCA32	261,0	87,6	56,8	Cabina armadio lineare CARRY tipo 1 / CARRY linear closet type 1
1	LR81S	103,8	205,6	95,4	Contenitore BLOCK orizzontale senza fianchi con letto singolo e piano scrittoio / Horizontal BLOCK cabinet without sides with single bed and desk
1	LR92S	261,0	124,6	59,0	Contenitore BLOCK verticale senza fianchi con letto 1 piazza e mezza e anta a ribalta superiore / Vertical BLOCK cabinet without sides with 3/4 bed and tilt door on top
3	LR93S	2,8	124,6	25,0	Ripiano per contenitore BLOCK verticale 1 piazza e mezza profondità 59 cm / Shelf for vertical Block cabinet 1 and 1/2 59 cm depth
1	LRA43S	97,4	205,6	33,4	2 mensole con tubo quadro 5x5 cm sopra contenitore BLOCK / 2 shelves with square tube 5x5 cm above BLOCK cabinet
1	MG06	58,0	205,6	2,0	Pannelli di fondo / Back panels
1	MG76	33,3	105,0	2,0	Anta scorrevole con guida / Sliding door with rail
1	MGT91	0,0	0,0	0,0	Maggiorazione aumento in larghezza pannello Carry / Supplement for increasing width of Carry panel
4	PX25LL	4,0	8,0	0,2	Maniglia ad incasso rettangolare con fondo e bordo laccato / Recessed rectangular handle with lacquered back and edge
1	PX26LL	4,0	20,0	0,2	Maniglia ad incasso rettangolare con fondo e bordo laccato / Recessed rectangular handle with lacquered back and edge
3	PX27LL	4,0	40,0	0,2	Maniglia ad incasso rettangolare con fondo e bordo laccato / Recessed rectangular handle with lacquered back and edge
1	SE72	90,5	65,0	65,0	Sedia con ruote e regolabile in altezza con scocca in legno e basamento in metallo / Chair on castors adjustable in height with wooden structure and metal base
1	SE79	90,5	65,0	65,0	Seduta imbottita sfoderabile per SE72 e SE76 / Upholstered and removable seat for SE72 and SE76
2	TS99M	2,8	62,8	59,2	Top di finitura costo minimo / Finishing top minimum cost
1	ZM40	31,6	0,0	0,0	Apertura push-pull / Push-pull opening

INGOMBRI / DIMENSIONS

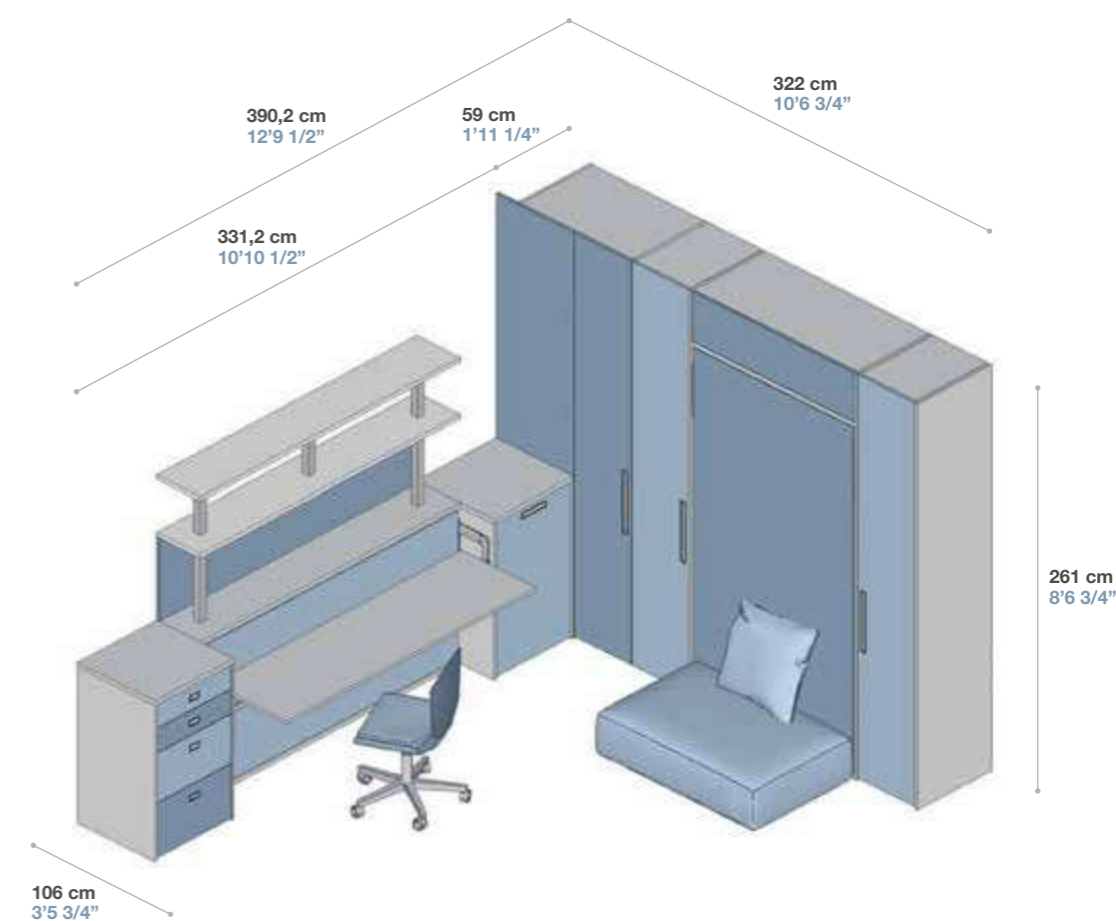
CONFIGURATION
360

FINITURE / FINISHES

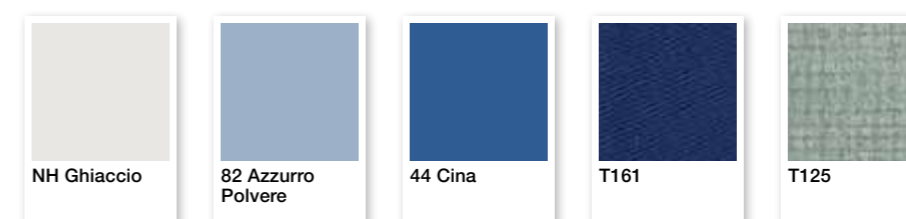

CONFIGURATION
361





Divano indipendente ON/OFF
con braccioli imbottiti
sp. 4 con meccanismo a scomparsa

ON/OFF self-standing sofa with
upholstered armrests
th. 4 and hidden mechanism

DESCRIZIONE TECNICA / TECHNICAL DATA

Q.TA Q.TY	CODICE CODE	A / H	L / W	P / D	DESCRIZIONE / DESCRIPTION
1	B134	261,0	41,6	56,8	Colonna armadio 1 anta / Column wardrobe 1 door
1	B146	261,0	85,6	56,8	Colonna armadio 2 ante / Column wardrobe 2 doors
2	DJ32	54,0	4,0	87,0	Bracciolo imbottito / Upholstered armrest
1	DJ35	76,0	123,0	91,0	Divano 1 posto e mezzo con movimento manuale / 1 and 1/2 seater sofa with manual recliner
1	FN48	261,0	3,2	59,0	Fianco SYSTEM 32 / SYSTEM 32 Side
1	FN58	261,0	2,5	56,8	Divisore intermedio / Intermediate Partition
2	FNC48	261,0	5,2	59,0	Fianco terminale 40+12 / End Side 40+12
1	KCA32	261,0	87,6	56,8	Cabina armadio lineare CARRY tipo 1 / CARRY linear closet type 1
1	LR92S	261,0	124,6	59,0	Contenitore BLOCK verticale senza fianchi con letto 1 piazza e mezza e anta a ribalta superiore / Vertical BLOCK cabinet without sides with 3/4 bed and tilt door on top
3	LR93S	2,8	124,6	25,0	Ripiano per contenitore BLOCK verticale 1 piazza e mezza profondità 59 cm / Shelf for vertical Block cabinet 1 and 1/2 59 cm depth
1	MGS2	4,0	166,6	59,0	Maggiorazione 1 raggiatura 5 cm / Supplement for 1 radius 5 cm
1	MGT91	0,0	0,0	0,0	Maggiorazione aumento in larghezza pannello Carry / Supplement for increasing width of Carry panel
1	MQA85	66,3	82,3	31,1	Elemento multivano pensile con 3 vani a giorno e 1 anta / Wall multi-sections cabinet with 3 open sections and 1 door
2	MQA86	66,3	82,3	31,1	Elemento multivano pensile con 3 vani a giorno e 1 anta / Wall multi-sections cabinet with 3 open sections and 1 door
2	MQA86	66,3	82,3	31,1	Elemento multivano pensile con 3 vani a giorno e 1 anta / Wall multi-sections cabinet with 3 open sections and 1 door
1	MY04	4,0	166,6	59,0	Piano sagomato o lineare senza supporti laterali / Shaped or linear top
4	PX27LN	4,0	40,0	0,2	Maniglia ad incasso rettangolare con fondo nobilitato e bordo laccato / Recessed rectangular handle with back in melamine and lacquered edge
1	SE72	90,5	65,0	65,0	Sedia con ruote e regolabile in altezza con scocca in legno e basamento in metallo / Chair on castors adjustable in height with wooden structure and metal base
1	SE79	90,5	65,0	65,0	Seduta imbottita sfoderabile per SE72 e SE76 / Upholstered and removable seat for SE72 and SE76

INGOMBRI / DIMENSIONS

CONFIGURATION
361

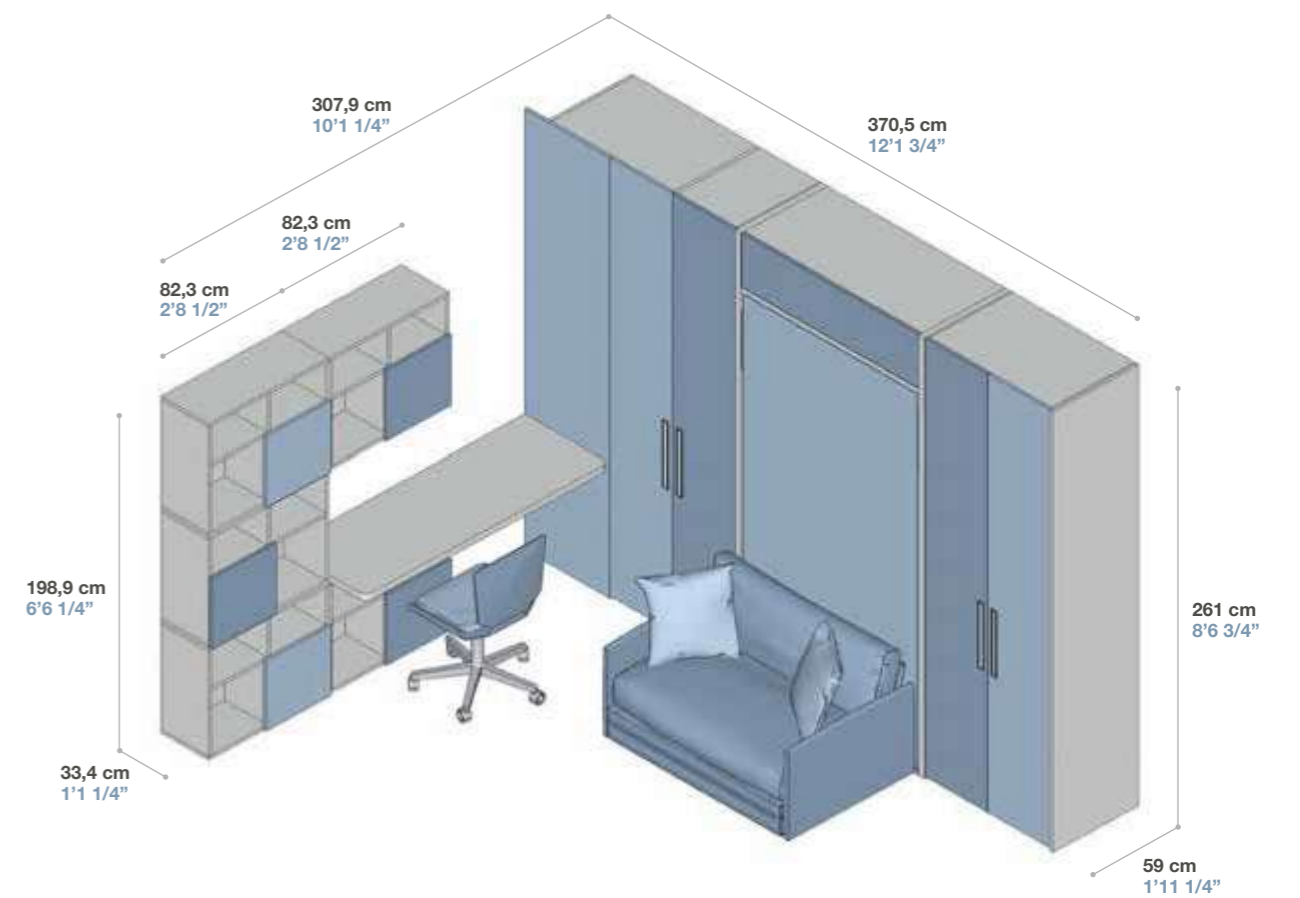

FINITURE / FINISHES

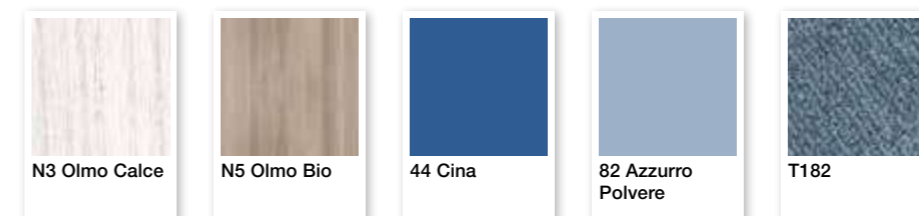

CONFIGURATION
362





Configuration 362

DESCRIZIONE TECNICA / TECHNICAL DATA

Q.TA Q.TY	CODICE CODE	A / H	L / W	P / D	DESCRIZIONE / DESCRIPTION
1	CSL36	50,0	37,5	43,7	Comodino con ruote con 1 cassetto e 1 cassettone / Night table on castors with 1 drawer and 1 high drawer
1	D130	229,0	33,6	58,8	Elemento terminale con schiena e 5 mensole / End unit with back and 5 shelves
1	DJ20	76,0	86,5	91,0	Poltrona 1 posto con movimento manuale / 1 seater armchair with manual recliner
1	DJ33	53,0	4,0	88,5	Profilo in legno / Wooden cover-up element
1	DJ41	40,0	83,0	91,0	Pouf fisso / Fixed pouf
2	FR77	229,0	4,0	33,4	Fianco finale sp. 4 cm per contenitore BLOCK / End side th. 4 cm for BLOCK cabinet
1	KCA04	261,0	123,6	104,0	Cabina armadio lineare SPRING tipo 2 / SPRING linear closet type 2
1	LRA10	63,8	88,0	2,0	Testata imbottita per contenitore prof. 33.4 cm / Upholstered headboard for cabinet depth 33.4 cm
1	LRA61S	229,0	88,0	33,4	Contenitore BLOCK verticale senza fianchi con letto singolo / Vertical BLOCK cabinet without sides with single bed
2	ML84	24,0	50,0	25,0	Mensola in metallo con fianchi e schiena in legno spessore 2 cm / Metal shelf with sides and wooden back thickness 2 cm
1	PX29LL	4,0	120,0	0,2	Maniglia ad incasso rettangolare con fondo e bordo laccato / Recessed rectangular handle with lacquered back and edge
1	SE10	97,0	65,0	65,0	Sedia con ruote e regolabile in altezza con scocca imbottita sfoderabile e basamento in metallo / Chair on castors adjustable in height with upholstered and removable structure and metal base
1	TC01S	98,0	66,0	27,5	Elemento pensile T-CLOUD con 4 vani a giorno / T-CLOUD wall box with 4 open sections
1	TC03	98,0	98,0	27,5	Elemento pensile T-CLOUD con 6 vani a giorno / T-CLOUD wall box with 6 open sections
1	TC08	29,4	29,4	1,2	Pannello con collegamenti USB e alimentazione di rete / Panel with USB ports and power supply
1	TQ82	24,0	166,6	59,0	Scrivania pensile spessore 4 cm con fascia H.20 cm / Wall desk thickness 4 cm with strip H.20 cm

INGOMBRI / DIMENSIONS

CONFIGURATION
362

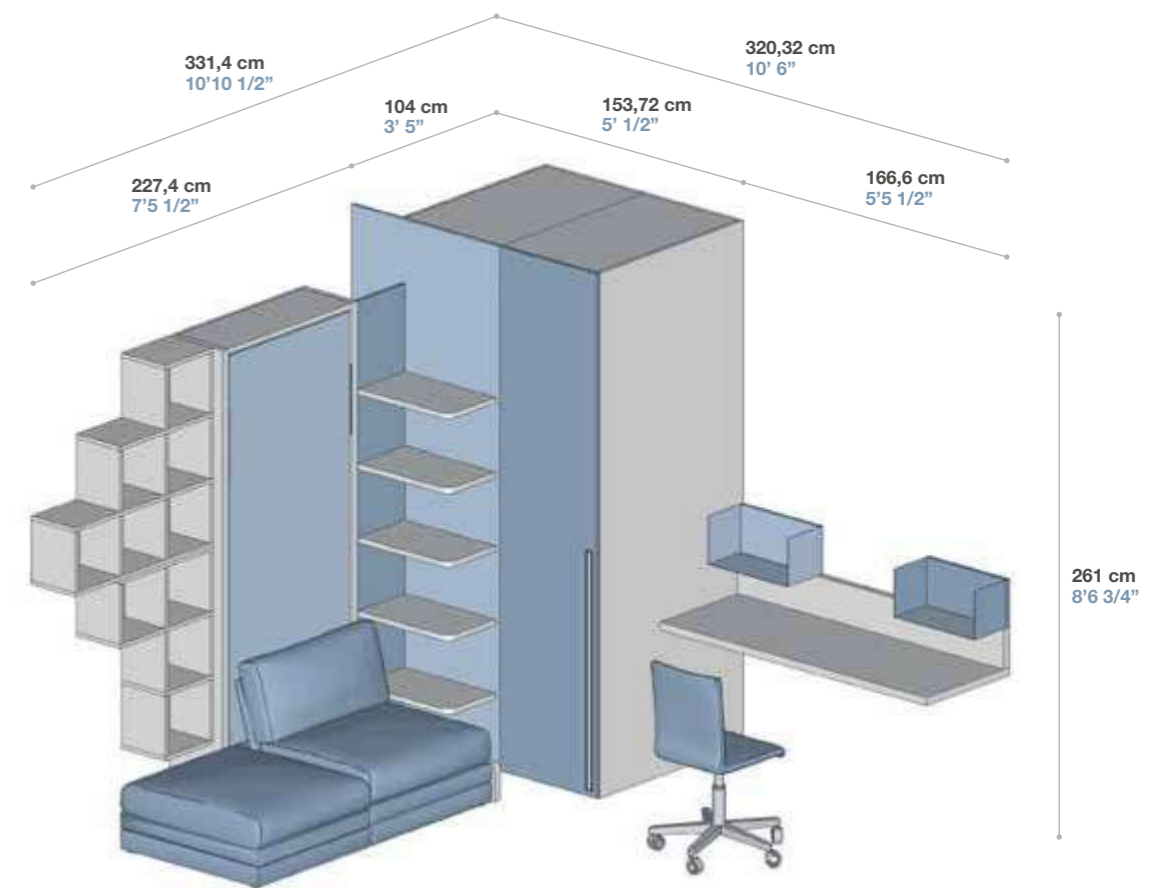

FINITURE / FINISHES

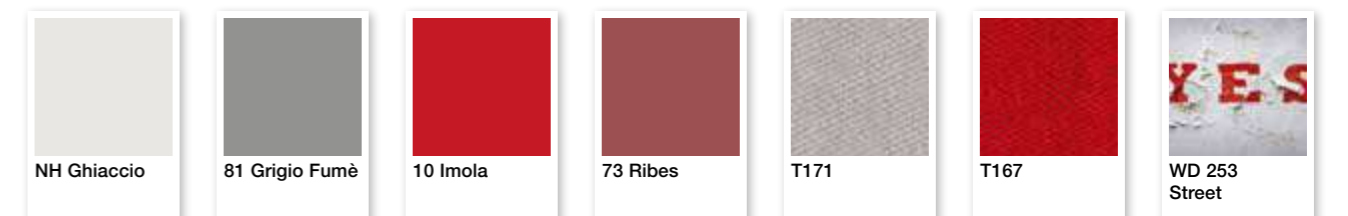

#BOHEMIAN WOMAN

LETTI A RIBALTA
Foldaway beds



Configuration 363

CONFIGURATION
363





Testata reclinabile.
Reclining headboard.



DESCRIZIONE TECNICA / TECHNICAL DATA

Q.TA Q.TY	CODICE CODE	A / H	L / W	P / D	DESCRIZIONE / DESCRIPTION
2	DJ32	54,0	4,0	87,0	Bracciolo imbottito / Upholstered armrest
1	DJ34	76,0	205,0	91,0	Divano 2 posti con movimento manuale / 2 seater sofa with manual recliner
1	EK61	69,0	44,0	33,4	Elemento pensile SYSTEM 28 da comp. 363 / Hanging column SYSTEM 28 from comp. 363
1	EK71	96,0	44,0	33,4	Elemento pensile SYSTEM 28 da comp. 363 / Hanging column SYSTEM 28 from comp. 363
1	FA63	69,0	2,8	33,4	Fianco SYSTEM 28 per elemento pensile / Side SYSTEM 28 for hanging column
1	FA63	96,0	2,8	33,4	Fianco SYSTEM 28 per elemento pensile / Side SYSTEM 28 for hanging column
3	FF42	69,0	2,8	46,2	Fianco SYSTEM 28 / SYSTEM 28 Side
1	FF46	197,0	2,8	46,2	Fianco SYSTEM 28 / SYSTEM 28 Side
2	FRA16	197,0	4,0	46,2	Fianco finale sp. 4 cm per contenitore BLOCK / End side th. 4 cm for BLOCK cabinet
1	FT20	46,2	155,5	2,0	Pannello generico a mq sp. 20 / General panel per sqm th. 20
1	LRA94S	197,0	205,6	46,2	Contenitore BLOCK orizzontale senza fianchi con letto matrimoniale / Horizontal BLOCK cabinet without sides with double bed
1	LRC93	41,0	140,0	4,0	Testata imbottita sfoderabile con meccanismo pieghevole / Upholstered and removable headboard with folding mechanism
1	Q510	197,0	44,0	46,2	Colonna libreria SYSTEM 28 da comp. 363 / Bookcase column SYSTEM 28 from comp. 363
2	Q511	69,0	44,0	46,2	Colonna libreria SYSTEM 28 da comp. 363 / Bookcase column SYSTEM 28 from comp. 363
1	Q512	69,0	58,8	46,2	Colonna libreria SYSTEM 28 da comp. 363 / Bookcase column SYSTEM 28 from comp. 363
1	TM05	75,5	159,7	65,0	Scrivania girevole spessore 4 cm / Rotating desk thickness 4 cm
1	UV99	100,0	383,9	0,1	Stampa digitale su pannello con immagine archivio Tumidei o cliente / Digital print on panel with image from Tumidei' library or from customer
1	ZM40	35,3	0,0	0,0	Apertura push-pull / Push-pull opening
3	ZM40	59,5	0,0	0,0	Apertura push-pull / Push-pull opening
1	ZM40	62,3	0,0	0,0	Apertura push-pull / Push-pull opening
1	ZM40	95,7	0,0	0,0	Apertura push-pull / Push-pull opening

INGOMBRI / DIMENSIONS

CONFIGURATION
363

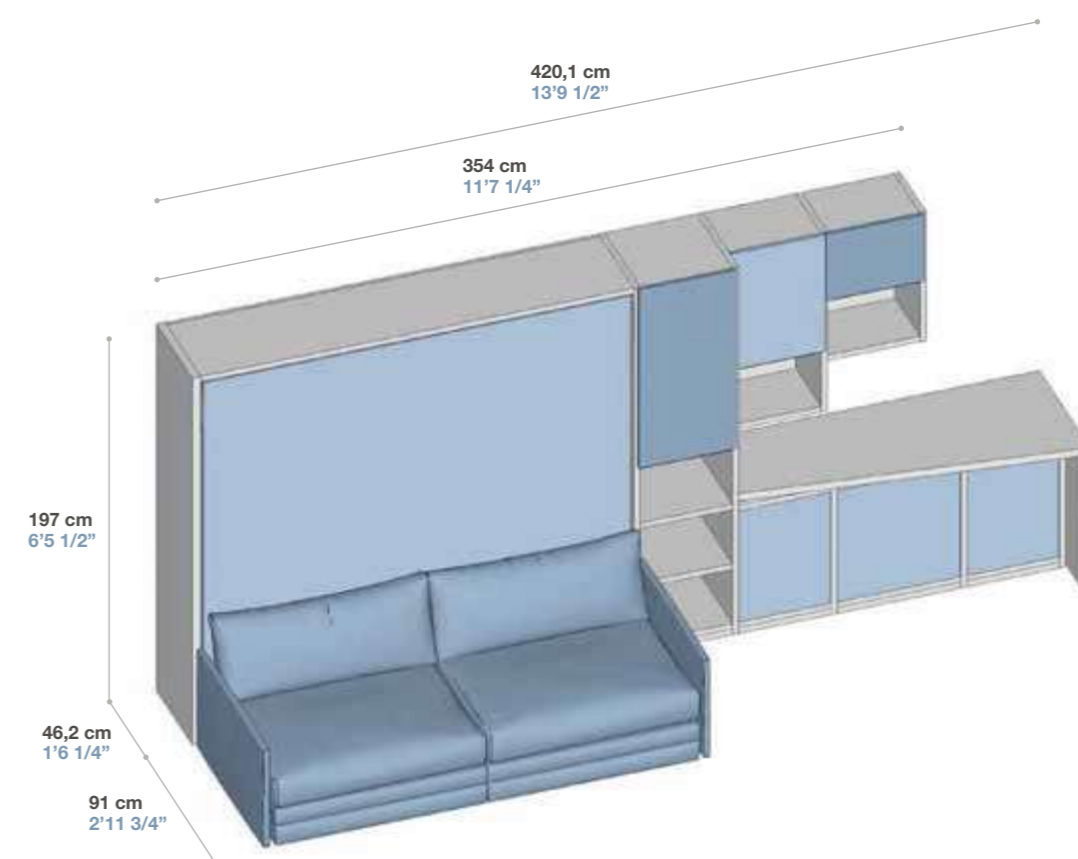

FINITURE / FINISHES

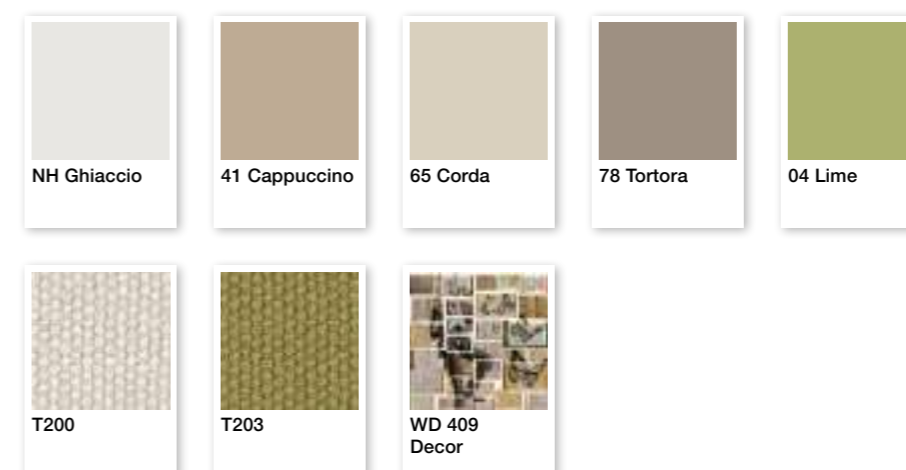

CONFIGURATION
364





DESCRIZIONE TECNICA / TECHNICAL DATA

Q.TA Q.TY	CODICE CODE	A / H	L / W	P / D	DESCRIZIONE / DESCRIPTION
1	B139	261,0	41,6	56,8	Colonna armadio 1 anta e 4 cassetti / Column wardrobe 1 door and 4 drawers
1	B146	261,0	85,6	56,8	Colonna armadio 2 ante / Column wardrobe 2 doors
1	D144	261,0	33,6	58,8	Elemento terminale con schiena 3 mensole e 1 specchio fra mensole / End unit with back and 3 shelves and 1 mirror between shelves
4	FN48	261,0	3,2	59,0	Fianco SYSTEM 32 / SYSTEM 32 Side
1	LR81S	103,8	205,6	95,4	Contenitore BLOCK orizzontale senza fianchi con letto singolo e piano scrittoio / Horizontal BLOCK cabinet without sides with single bed and desk
1	LRA23	157,2	205,6	59,0	Elemento pensile con ante scorrevoli sopra contenitore BLOCK orizzontale con letto singolo / Wall element with sliding doors above BLOCK horizontal cabinet with single bed
1	MGLLRA23	157,2	205,6	59,0	Maggiorazione laccatura pannello / Supplement for lacquered panel
4	PX25LL	4,0	8,0	0,2	Maniglia ad incasso rettangolare con fondo e bordo laccato / Recessed rectangular handle with lacquered back and edge
2	PX26LL	4,0	20,0	0,2	Maniglia ad incasso rettangolare con fondo e bordo laccato / Recessed rectangular handle with lacquered back and edge
1	PX27LL	4,0	40,0	0,2	Maniglia ad incasso rettangolare con fondo e bordo laccato / Recessed rectangular handle with lacquered back and edge
2	PX28LL	4,0	80,0	0,2	Maniglia ad incasso rettangolare con fondo e bordo laccato / Recessed rectangular handle with lacquered back and edge

INGOMBRI / DIMENSIONS

CONFIGURATION

364

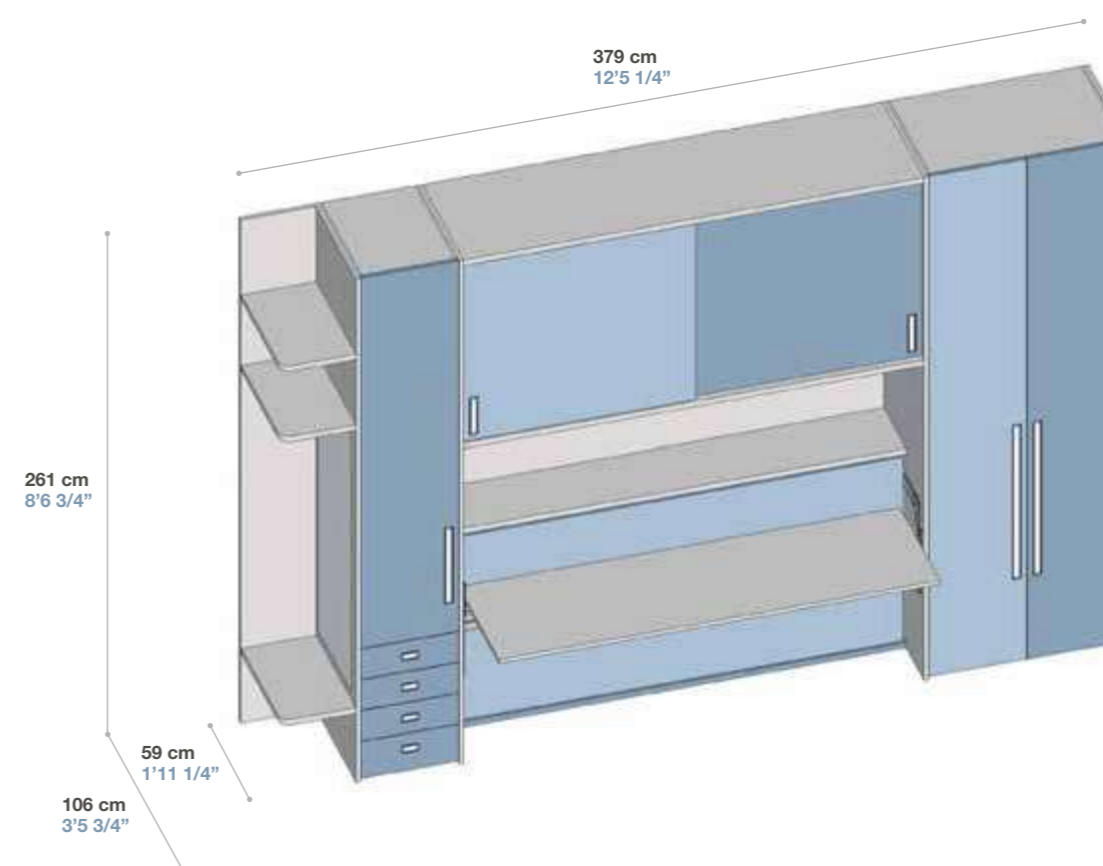

FINITURE / FINISHES



N5 Olmo Bio



47 Argilla



46 Muschio

CONFIGURATION
365





DESCRIZIONE TECNICA / TECHNICAL DATA

Q.TA Q.TY	CODICE CODE	A / H	L / W	P / D	DESCRIZIONE / DESCRIPTION
1	B139	261,0	41,6	56,8	Colonna armadio 1 anta e 4 cassetti / Column wardrobe 1 door and 4 drawers
1	B146	261,0	85,6	56,8	Colonna armadio 2 ante / Column wardrobe 2 doors
1	E188	98,0	205,6	33,4	Libreria composta con sistema a tubo quadro / Composed bookcase with square tube system
3	EZ21	1,4	1,4	14,5	Reggimensola a scomparsa con foratura / Concealed bracket for shelf with drilling
4	FN48	261,0	3,2	59,0	Fianco SYSTEM 32 / SYSTEM 32 Side
1	LR82S	103,8	205,6	121,0	Contenitore BLOCK orizzontale senza fianchi con letto singolo e piano scrittoio / Horizontal BLOCK cabinet without sides with single bed and desk
1	LR83	98,2	205,6	25,0	Ripiano e divisori per contenitore prof. 59 cm con letto singolo / Shelf and partitions for cabinet depth 59 cm with single bed
2	MG76	33,3	105,0	2,0	Anta scorrevole con guida / Sliding door with rail
4	PX25LL	4,0	8,0	0,2	Maniglia ad incasso rettangolare con fondo e bordo laccato / Recessed rectangular handle with lacquered back and edge
1	PX27LL	4,0	40,0	0,2	Maniglia ad incasso rettangolare con fondo e bordo laccato / Recessed rectangular handle with lacquered back and edge
1	PX28LL	4,0	80,0	0,2	Maniglia ad incasso rettangolare con fondo e bordo laccato / Recessed rectangular handle with lacquered back and edge

INGOMBRI / DIMENSIONS

CONFIGURATION

365

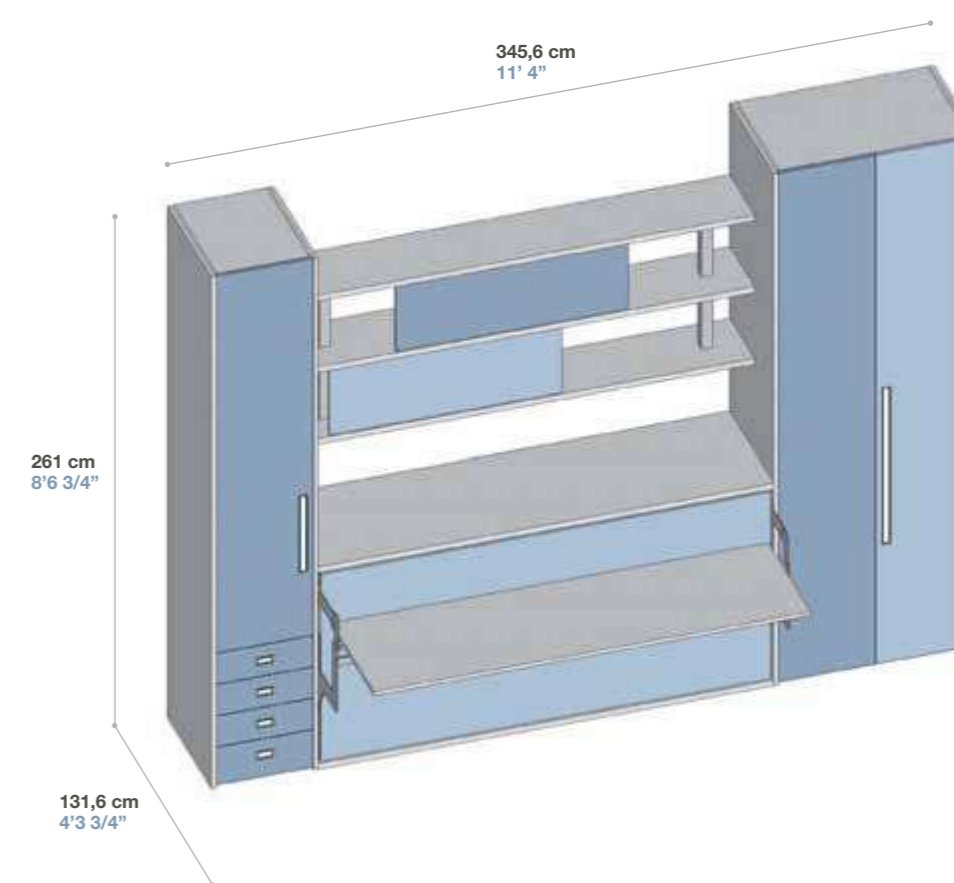

FINITURE / FINISHES

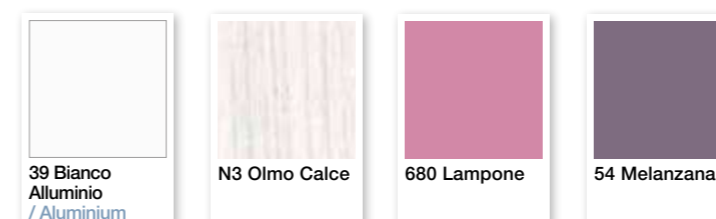



#CREATIVE GIRL

LETTI A RIBALTA
Foldaway beds







Q.TA Q.TY	CODICE CODE	A / H	L / W	P / D	DESCRIZIONE / DESCRIPTION
1	B141	261,0	56,4	56,8	Colonna armadio 1 anta / Column wardrobe with 1 door
2	FN48	261,0	3,2	59,0	Fianco SYSTEM 32 / SYSTEM 32 Side
2	FR64	133,0	2,8	33,4	Fianco finale sp. 2,8 cm per contenitore BLOCK / End side th. 2,8 cm for BLOCK cabinet
1	FX54	125,2	2,0	59,0	Fianco SYSTEM 20 / SYSTEM 20 Side
1	GR23	73,2	4,0	59,0	Gamba telaio in metallo / Frame leg in metal
1	LR84S	135,8	205,6	33,4	Contenitore BLOCK orizzontale senza fianchi con letto 1 piazza e mezza / Horizontal BLOCK cabinet without sides with 3/4 bed
1	MJB957	4,0	166,6	90,0	Piano sagomato sp.4 cm / Shaped top th.4 cm
1	PE67K	125,2	117,6	56,8	Elemento pensile per ponti lineari con 2 ante in sovrapposizione / Wall element for linear bridges with 2 overlapping doors
2	PX26LL	4,0	20,0	0,2	Maniglia ad incasso rettangolare con fondo e bordo laccato / Recessed rectangular handle with lacquered back and edge
1	PX28LL	4,0	80,0	0,2	Maniglia ad incasso rettangolare con fondo e bordo laccato / Recessed rectangular handle with lacquered back and edge
1	SE72	90,5	65,0	65,0	Sedia con ruote e regolabile in altezza con scocca in legno e basamento in metallo / Chair on castors adjustable in height with wooden structure and metal base
1	SE79	90,5	65,0	65,0	Seduta imbottita sfoderabile per SE72 e SE76 / Upholstered and removable seat for SE72 and SE76
1	TC01	98,0	66,0	27,5	Elemento pensile T-CLOUD con 4 vani a giorno / T-CLOUD wall box with 4 open sections
1	TC02	130,0	130,0	27,5	Elemento pensile T-CLOUD con 8 vani a giorno / T-CLOUD wall box with 8 open sections

366

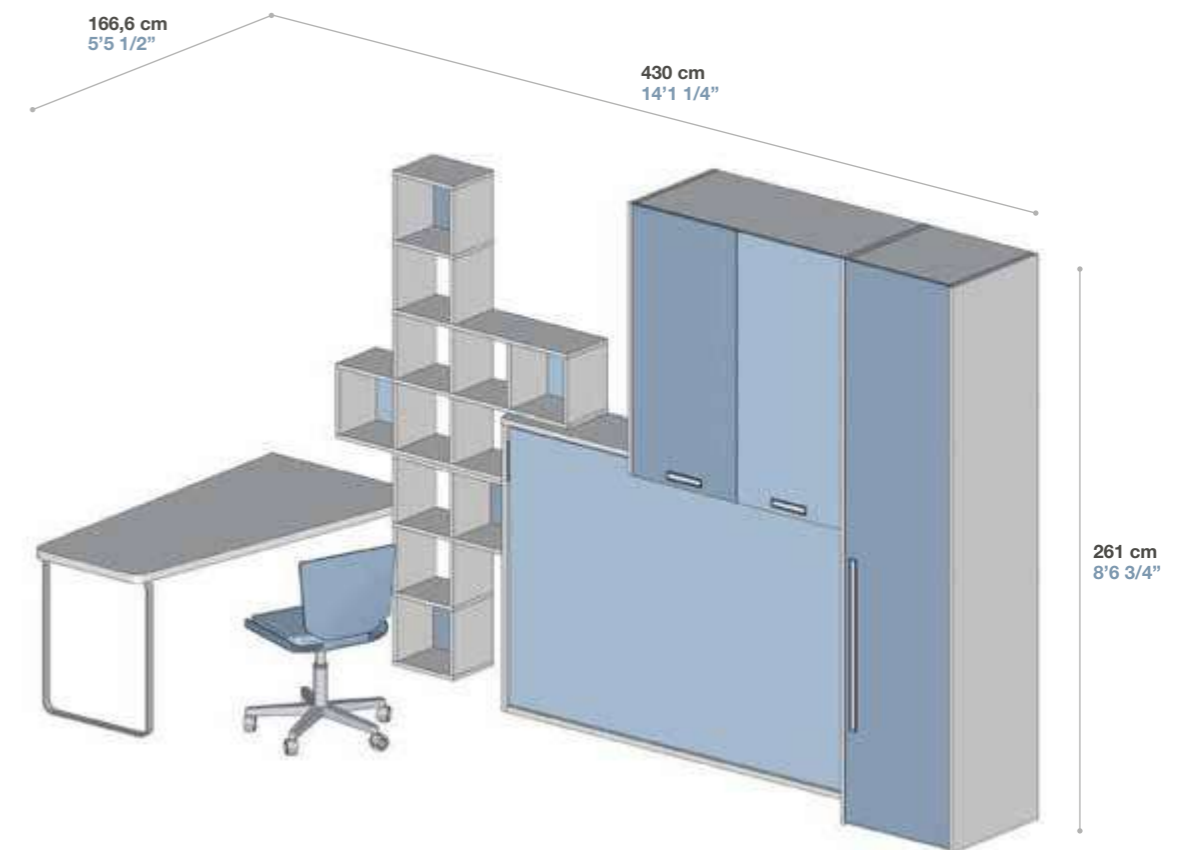

FINITURE / FINISHES

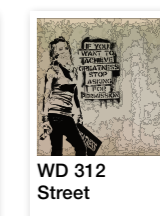
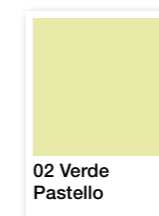
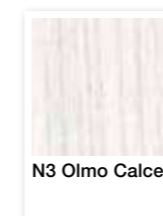

CONFIGURATION
367





DESCRIZIONE TECNICA / TECHNICAL DATA

Q.TA Q.TY	CODICE CODE	A / H	L / W	P / D	DESCRIZIONE / DESCRIPTION
1	B134	261,0	41,6	56,8	Colonna armadio 1 anta / Column wardrobe 1 door
2	FN38	261,0	2,0	59,0	Fianco SYSTEM 20 / SYSTEM 20 Side
2	FN48	261,0	3,2	59,0	Fianco SYSTEM 32 / SYSTEM 32 Side
1	GEA12	261,0	102,7	102,7	Cabina armadio ad angolo tipo D con ante battenti / Corner closet Type D with hinged doors
1	LR19S	261,0	205,6	59,0	Contenitore BLOCK senza fianchi con 2 letti singoli arretrati e ante scorrevoli / BLOCK cabinet without sides with 2 back single beds and sliding doors
1	PR21	261,0	205,6	59,0	Rivestimento in tessuto per protezione letto / Covering in fabric for bed protection
5	PX04	1,0	7,4	3,2	Maniglia a forma C / C-shaped handle
2	PX05	1,0	17,0	3,8	Maniglia a forma C / C-shaped handle
1	UV99	100,0	125,2	0,1	Stampa digitale su pannello con immagine archivio Tumidei o cliente / Digital print on panel with image from Tumidei' library or from customer

INGOMBRI / DIMENSIONS

CONFIGURATION
367

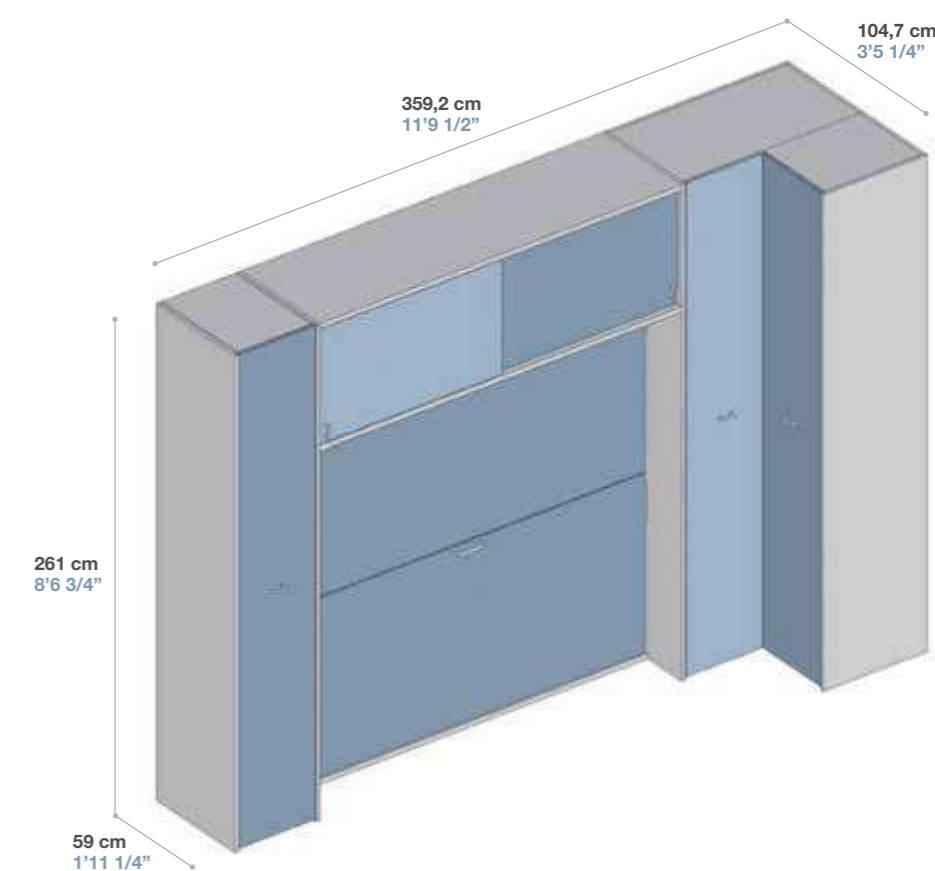

FINITURE / FINISHES

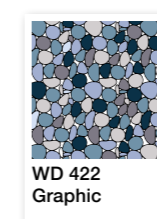
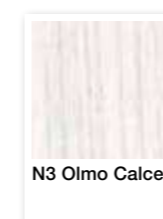

#ROMANTIC GIRLS

CABINE
Walk-in-closets



Configuration 368

CONFIGURATION
368





DESCRIZIONE TECNICA / TECHNICAL DATA

Q.TA Q.TY	CODICE CODE	A / H	L / W	P / D	DESCRIZIONE / DESCRIPTION
1	B145	261,0	56,4	56,8	Colonna armadio 1 anta e 4 cassetti / Column wardrobe with 1 door and 4 drawers
2	FN48	261,0	3,2	59,0	Fianco SYSTEM 32 / SYSTEM 32 Side
1	KCA06	261,0	162,8	104,0	Cabina armadio lineare SPRING tipo 3 / SPRING linear closet type 3
1	LR36	62,1	95,0	203,5	Letto LORY singolo inferiore scorrevole su ruote con rete a doghe e 2 cassettoni / LORY lower single bed sliding on castors with slatted base and 2 cassettoni
1	MF19	2,8	205,8	25,0	Mensola lineare con reggimensola a scomparsa / Linear shelf with concealed bracket
6	MG58	2,8	33,4	56,8	Mensola per elemento terminale con schiena / Shelf for end unit with back
1	MGLLR36	0,0	0,0	0,0	Maggiorazione laccatura coppia cassetti letto / Supplement for couple of bed drawers in lacquered
3	MGLPN74	132,6	69,2	2,0	Maggiorazione laccatura pannello boiserie sottoponte / Supplement for wall panel under bridge lacquering
1	P959N	178,0	215,0	87,6	Letto a sbalzo estraibile e pedana per passaggio / Overhang pull-out bed and platform for walking
8	PX35L	8,0	8,0	4,7	Pomolo ovale in frassino laccato / Oval knob in lacquered ash
2	PX36L	11,0	11,0	4,7	Pomolo ovale in frassino laccato / Oval knob in lacquered ash
1	SCL03	102,6	41,4	87,6	Scala con 3 gradini / Stair with 3 steps

INGOMBRI / DIMENSIONS

CONFIGURATION
368

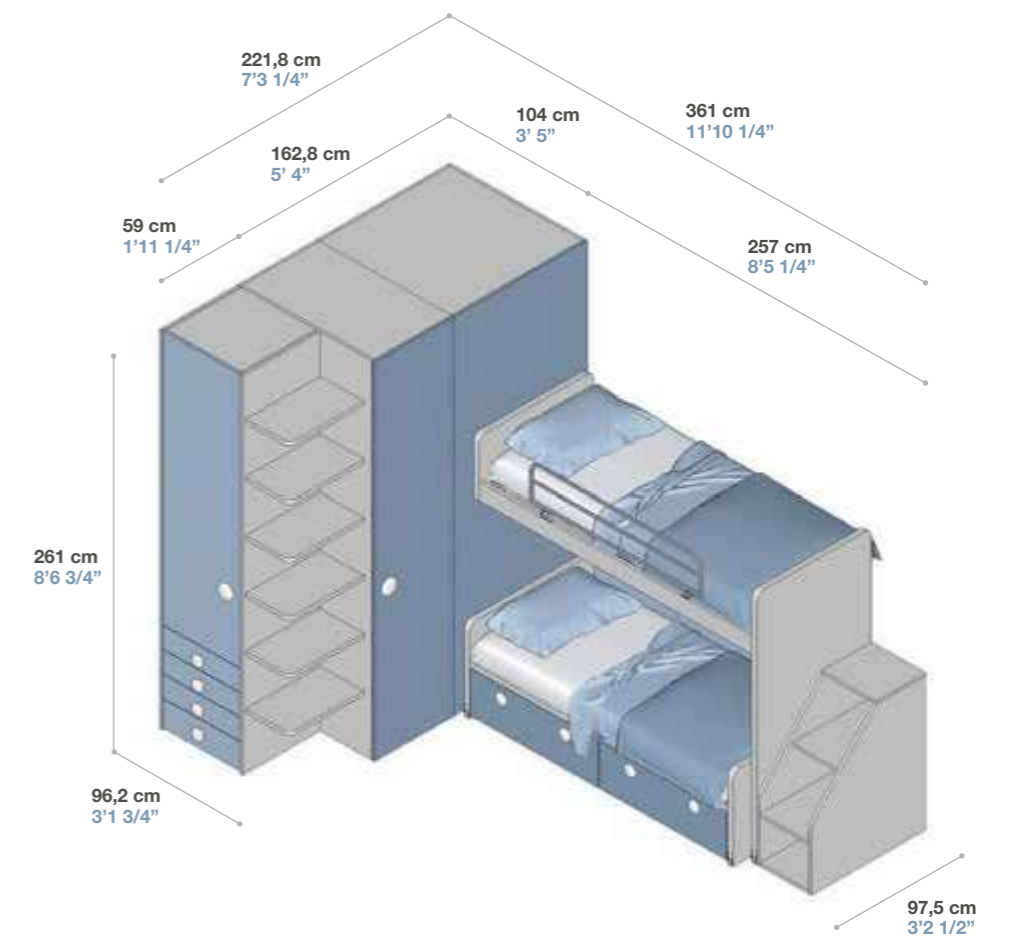

FINITURE / FINISHES

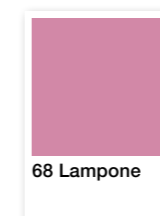
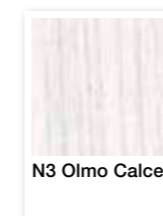

CONFIGURATION
369







DESCRIZIONE TECNICA / TECHNICAL DATA

Q.TA Q.TY	CODICE CODE	A / H	L / W	P / D	DESCRIZIONE / DESCRIPTION
1	KCA04	261,0	123,6	104,0	Cabina armadio lineare SPRING tipo 2 / SPRING linear closet type 2
1	LX78X	75,0	99,5	217,0	Letto SYSTEM SCRIGNO singolo imbottito con rete estraibile e testata H.75 cm e spessore 10 cm / SYSTEM SCRIGNO upholstered single bed with pull-out slatted base and headboard H.75 cm th.10 cm
1	MGT23	75,0	99,5	217,0	Magg. per coppia di pistoni di sostegno al longone frontale a ribalta / Suppl. for couple of pistons to support tilt front side
2	ML83	24,0	37,0	25,0	Mensola in metallo con fianchi e schiena in legno / Metal shelf with sides and wooden back
1	ML85	24,0	100,0	25,0	Mensola in metallo con fianchi e schiena in legno spessore 2 cm / Metal shelf with sides and wooden back thickness 2 cm
2	MQ73	18,0	52,3	41,5	Comodino pensile con 1 cassetto / Hanging night table with 1 drawer
1	P773N	261,0	220,0	56,8	Ponte lineare SPAZIO 25 con 5 ante battenti / SPAZIO 25 linear bridge with 5 hinged doors
1	P970	261,0	2,0	56,8	Elemento terminale di sostegno in metallo e fianco per elemento pensile H.96 cm / End metal support and side for wall unit H.96 cm
3	PX26LL	4,0	20,0	0,2	Maniglia ad incasso rettangolare con fondo e bordo laccato / Recessed rectangular handle with lacquered back and edge
1	PX28LL	4,0	80,0	0,2	Maniglia ad incasso rettangolare con fondo e bordo laccato / Recessed rectangular handle with lacquered back and edge
1	TQ81	24,0	133,4	59,0	Scrivania pensile spessore 4 cm con fascia H.20 cm / Wall desk thickness 4 cm with strip H.20 cm
2	VS26	20,0	100,0	20,5	Mensola T-BOX L 100 cm / T-BOX shelf W 100 cm

INGOMBRI / DIMENSIONS

CONFIGURATION
369

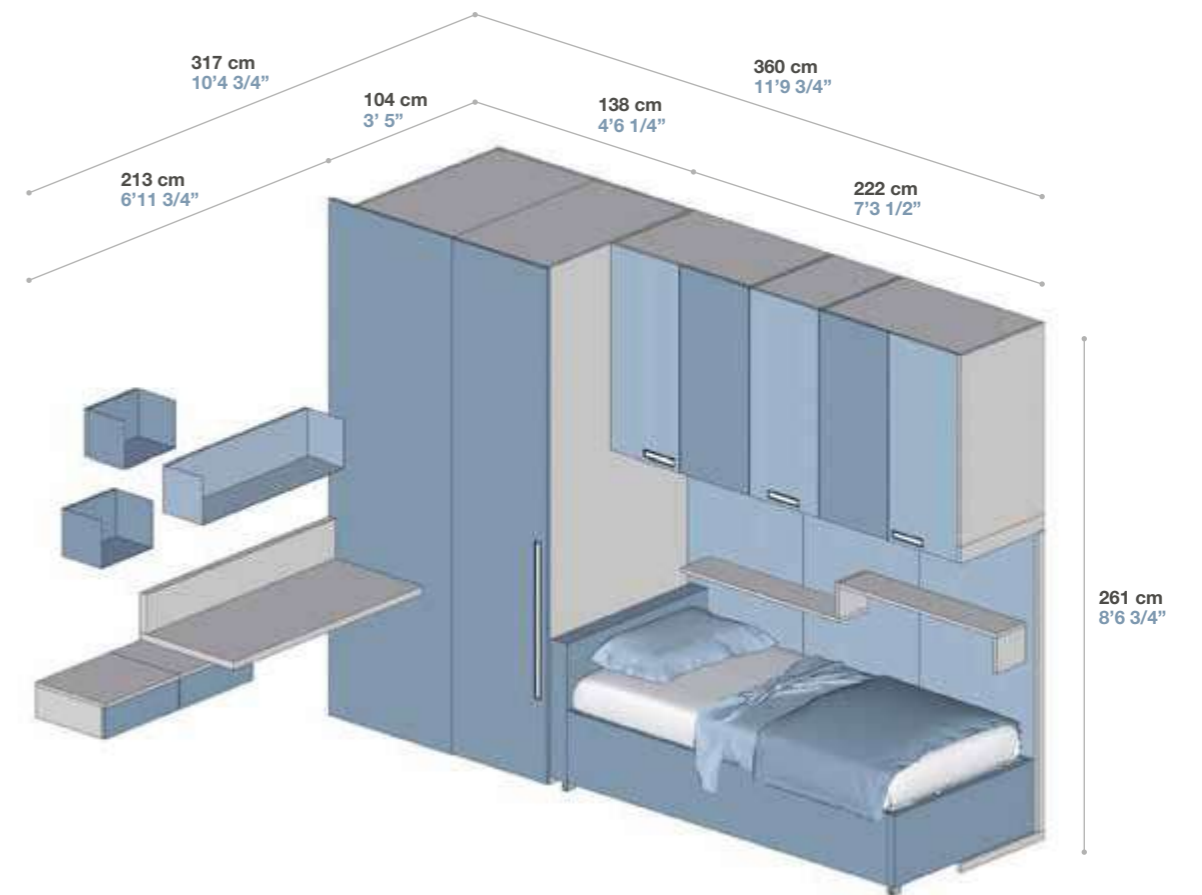

FINITURE / FINISHES

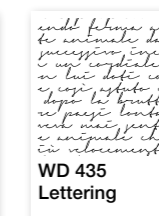
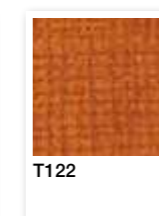



#FOOTBALL PLAYERS

CABINE
Walk-in-closets



CONFIGURATION
370





DESCRIZIONE TECNICA / TECHNICAL DATA

Q.TA Q.TY	CODICE CODE	A / H	L / W	P / D	DESCRIZIONE / DESCRIPTION
1	GH63	73,2	5,0	5,0	Tubo quadro 5x5 cm con piastra e piede per sostegno piani / Floor square tube 5x5 cm with plate and foot for tops support
1	KCA28	261,0	223,6	104,0	Cabina armadio lineare BOOK tipo 9 con libreria / BOOK linear closet type 9 with bookcase
1	LR36	62,1	95,0	203,5	Letto LORY singolo inferiore scorrevole su ruote con rete a doghe e 2 cassettoni / LORY lower single bed sliding on castors with slatted base and 2 drawers
1	LR37	95,7	97,0	214,5	Letto LORY singolo superiore scorrevole su ruote con rete a doghe / LORY upper single bed sliding on castors with slatted base
1	MJB948	4,0	104,0	104,0	Piano sagomato sp.4 cm COMPO 948 / Shaped top th.4 cm COMPO 948
3	ML84	24,0	50,0	25,0	Mensola in metallo con fianchi e schiena in legno spessore 2 cm / Metal shelf with sides and wooden back thickness 2 cm
2	ML85	24,0	100,0	25,0	Mensola in metallo con fianchi e schiena in legno spessore 2 cm / Metal shelf with sides and wooden back thickness 2 cm
2	PX26LN	4,0	20,0	0,2	Maniglia ad incasso rettangolare con fondo nobilitato e bordo laccato / Recessed rectangular handle with back in melamine and lacquered edge
1	PX29LN	4,0	120,0	0,2	Maniglia ad incasso rettangolare con fondo nobilitato e bordo laccato / Recessed rectangular handle with back in melamine and lacquered edge
1	SE72	90,5	65,0	65,0	Sedia con ruote e regolabile in altezza con scocca in legno e basamento in metallo / Chair on castors adjustable in height with wooden structure and metal base
1	SE79	90,5	65,0	65,0	Seduta imbottita sfoderabile per SE72 e SE76 / Upholstered and removable seat for SE72 and SE76

INGOMBRI / DIMENSIONS

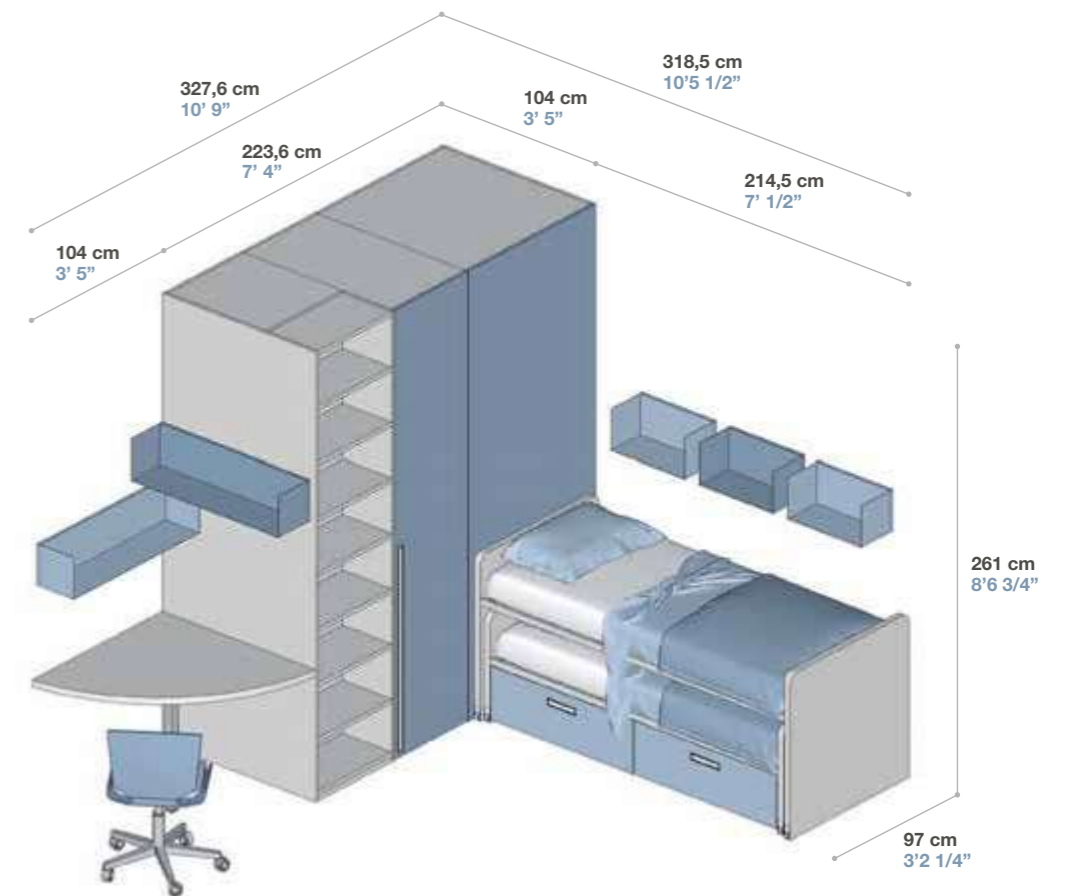
CONFIGURATION
370

FINITURE / FINISHES

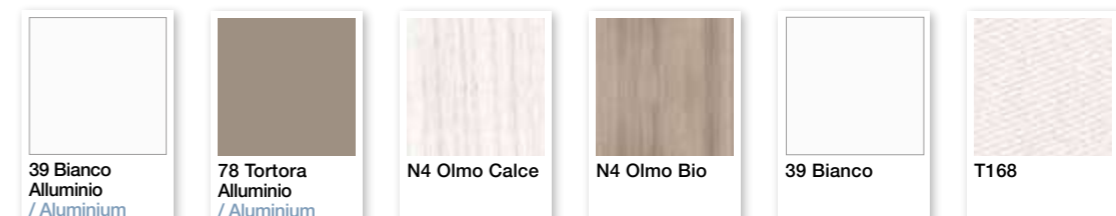

CONFIGURATION

371



SMART ITALIAN PROJECTS

Configuration 371



DESCRIZIONE TECNICA / TECHNICAL DATA

Q.TA Q.TY	CODICE CODE	A / H	L / W	P / D	DESCRIZIONE / DESCRIPTION
1	FN38	261,0	2,0	59,0	Fianco SYSTEM 20 / SYSTEM 20 Side
1	GH63	73,2	5,0	5,0	Tubo quadro 5x5 cm con piastra e piede per sostegno piani / Floor square tube 5x5 cm with plate and foot for tops support
1	KCA10	261,0	223,6	104,0	Cabina armadio lineare SPRING tipo 5 / SPRING linear closet type 5
3	KCR22	2,5	100,0	46,2	Ripiano lineare per cabina armadio lineare / Linear shelf for linear closet
1	KK9G	68,0	100,0	46,2	Cassettiera interna con 3 cassetti e 2 ripiani / Inner chest of drawers with 3 drawers and 2 shelves
1	LR36	62,1	95,0	203,5	Letto LORY singolo inferiore scorrevole su ruote con rete a doghe e 2 cassettoni / LORY lower single bed sliding on castors with slatted base and 2 drawers
1	MJB949	4,0	118,0	59,0	Piano sagomato sp.4 cm / Shaped top th.4 cm
1	ML84	24,0	50,0	25,0	Mensola in metallo con fianchi e schiena in legno spessore 2 cm / Metal shelf with sides and wooden back thickness 2 cm
1	MY04	4,0	104,0	59,0	Piano sagomato o lineare senza supporti laterali / Shaped or linear top
1	P903	261,0	226,0	59,0	Ponte lineare SPAZIO 5 con 2 ante scorrevoli / SPAZIO 5 linear bridge with 2 sliding doors
2	PX26LL	4,0	20,0	0,2	Maniglia ad incasso rettangolare con fondo e bordo laccato / Recessed rectangular handle with lacquered back and edge
2	PX27LL	4,0	40,0	0,2	Maniglia ad incasso rettangolare con fondo e bordo laccato / Recessed rectangular handle with lacquered back and edge
1	PX29LL	4,0	120,0	0,2	Maniglia ad incasso rettangolare con fondo e bordo laccato / Recessed rectangular handle with lacquered back and edge
1	SE72	90,5	65,0	65,0	Sedia con ruote e regolabile in altezza con scocca in legno e basamento in metallo / Chair on castors adjustable in height with wooden structure and metal base
1	SE79	90,5	65,0	65,0	Seduta imbottita sfoderabile per SE72 e SE76 / Upholstered and removable seat for SE72 and SE76
1	TN67	73,2	4,0	59,0	Fianco lineare spessore 4 cm / Linear Side thickness 4 cm
1	UV99	100,0	162,5	0,1	Stampa digitale su pannello con immagine archivio Tumidei o cliente / Digital print on panel with image from Tumidei' library or from customer
1	UV99	100,0	372,0	0,1	Stampa digitale su pannello con immagine archivio Tumidei o cliente / Digital print on panel with image from Tumidei' library or from customer
4	VS25	20,0	56,5	20,5	Mensola T-BOX L 56.5 cm / T-BOX shelf W 56.5 cm
3	VS26	20,0	100,0	20,5	Mensola T-BOX L 100 cm / T-BOX shelf W 100 cm

INGOMBRI / DIMENSIONS

CONFIGURATION

371

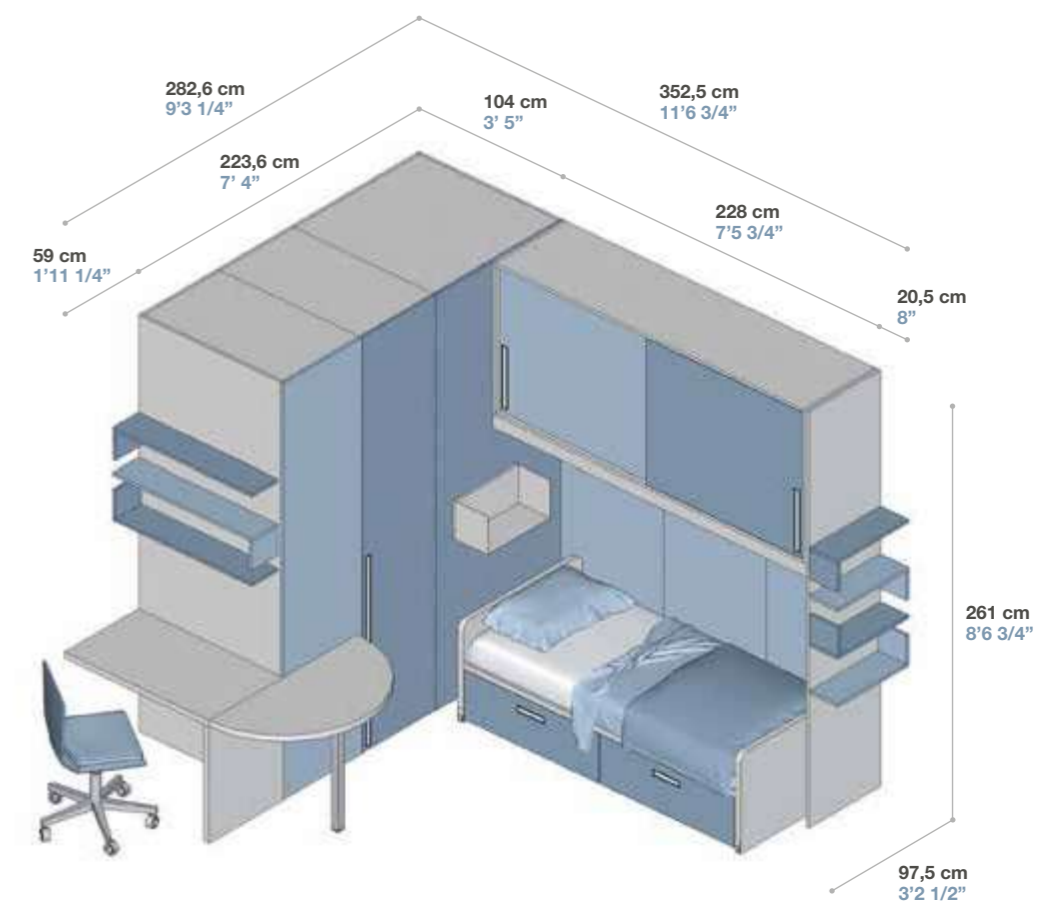

FINITURE / FINISHES



CARTA DA PARATI IN FIBRA DI VETRO.
/ WALLPAPER IN GLASS FIBERS.



Carta da parati in tessuto realizzato con filati speciali di fibre di vetro molto sottili, ignifugo omologato in CLASSE 1. Il tessuto è ecologico e igienico, realizzato con materie prime naturali non è né tossico né contaminabile da agenti biologici. "CERTIFICATO DA GREENGUARD", seguendo severi metodi di laboratorio, ed è risultato in linea con gli standard del programma Greenguard Indoor Air Quality.

Wallpaper fabric made with special yarns of very thin glass fibres, fireproof and homologated in CLASS 1. The fabric is ecological and hygienic, made with natural raw materials and it is non-toxic, neither contaminated by biological agents. "CERTIFIED BY GREENGUARD" means that the product was tested following strict laboratory methods, and the result complies with the standards set out in the Greenguard Indoor Air Quality program.



Caratteristiche tecniche sono indicate nel catalogo DRESS IMAGE.

Technical characteristics are included in the DRESS IMAGE catalogue.

PANNELLI DECORATI CON STAMPE DIGITALI.
/ PANELS WITH DIGITAL PRINTS.



Stampe digitali per armadi e pannellature.
Digital prints for wardrobes and panels.

TUMIDEI utilizza per tutte le ante di armadi comprese quelle con la stampa digitale legni che provengono da coltivazioni ecosostenibili, a basso contenuto di formaldeide e finiti con vernici all'acqua con barriere igienizzanti antibatteriche.

TUMIDEI uses for all its wardrobe doors, also the ones with digital print, wood coming from eco-sustainable cultivated land, with a low-formaldehyde content and lacquered with water-based paints with anti-bacterial barriers.

Tutte le stampe sui prodotti TIRAMOLLA sono certificate con il sistema "GREENGUARD" un processo di certificazione in linea con gli standard del programma Greenguard Indoor Air Quality contro le emissioni inquinanti all'interno degli edifici.

All prints on TIRAMOLLA product are certified with "GREENGUARD" system, a certifying process complying with the standard set out in the Greenguard Indoor Air Quality program against polluting emissions inside buildings.



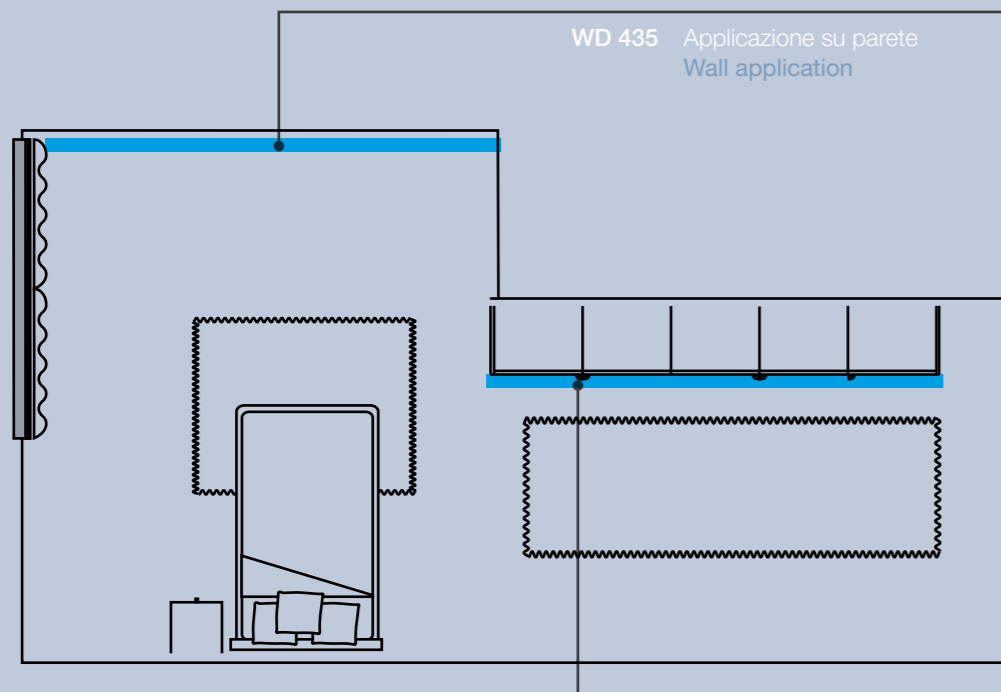

WD 435 Applicazione su parete
Wall application

WD 416 Stampa digitale su armadio
(solo su ante in nobilitato dove previsto)
Digital print on wardrobe
(only doors in melamine, where feasible)



WD 438 Applicazione su parete
Wall application

Parete rivestita con rotoli in tessuto
Wall finished with fabric rolls

TIK 452 Applicazione adesivo su anta
Sticker application on doors

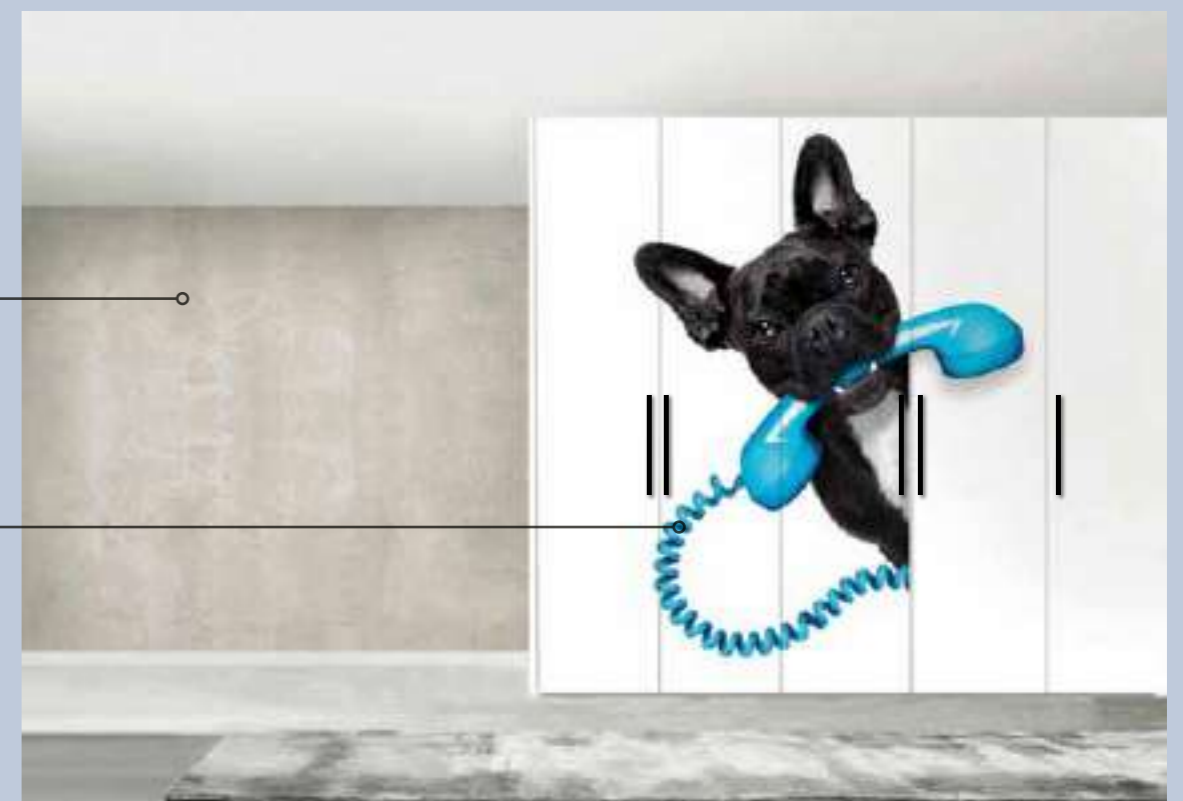

DRESS IMAGE

DECOR

Archivio Tumidei delle immagini fotografiche.

Tumidei's library of photographic images.



WD 101F



WD 101



WD 352



WD 355

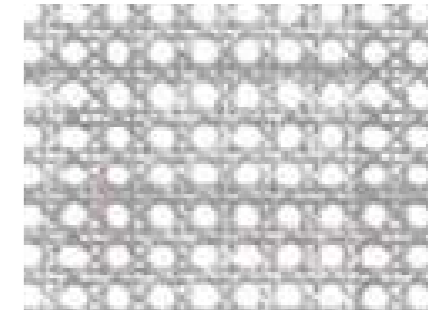

WD 400



WD 109



WD 130



WD 130F



WD 401



WD 402

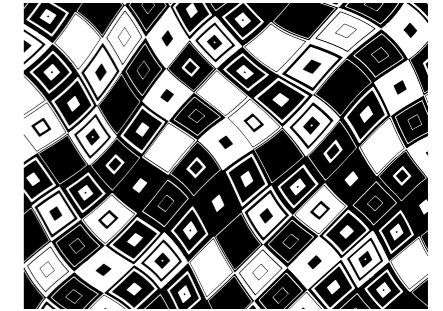

WD 403



WD 132



WD 173



WD 174

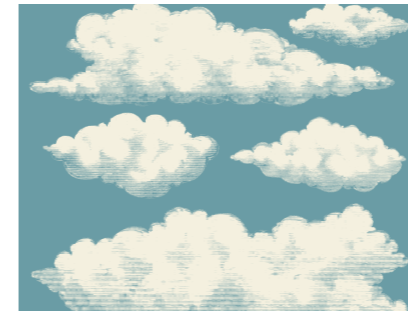

WD 404



WD 405



WD 406



WD 175



WD 226



WD 258



WD 407



WD 408



WD 409



WD 265



WD 302



WD 346

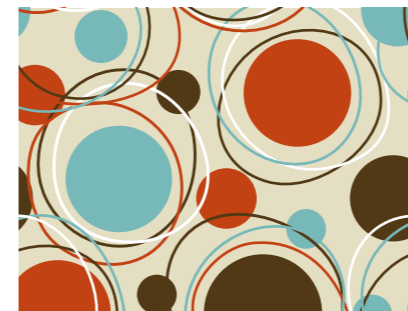

WD 410



WD 411



WD 412

DRESS IMAGE

GRAPHIC

Archivio Tumidei delle immagini fotografiche.

Tumidei's library of photographic images.



WD 115



WD 116



WD 414



WD 415



WD 416



WD 152



WD 159



WD 160



WD 417



WD 418



WD 419



WD 165

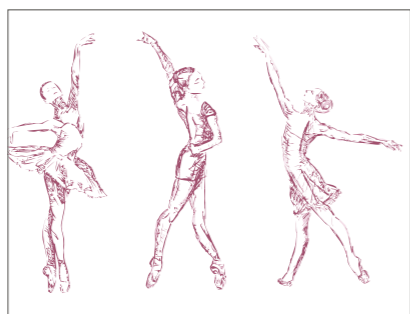

WD 170



WD 210



WD 420



WD 421

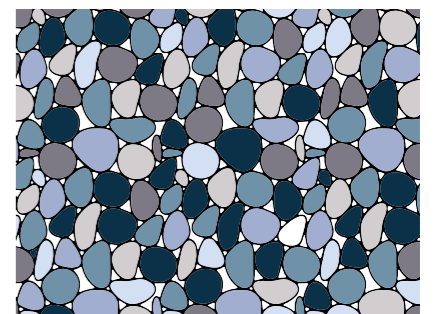

WD 422



WD 229

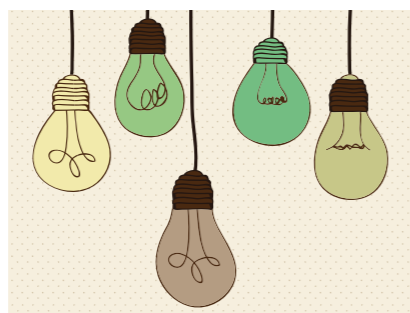

WD 235



WD 273



WD 423



WD 424

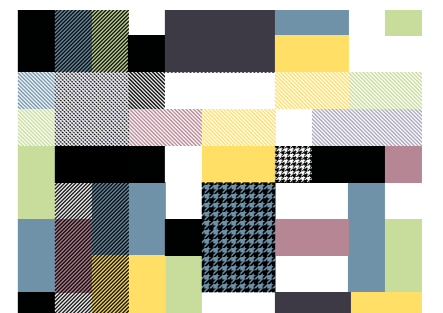

WD 425



WD 282

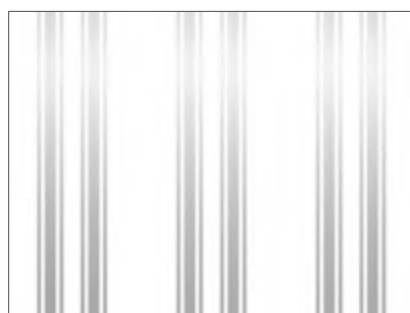

WD 311



WD 413

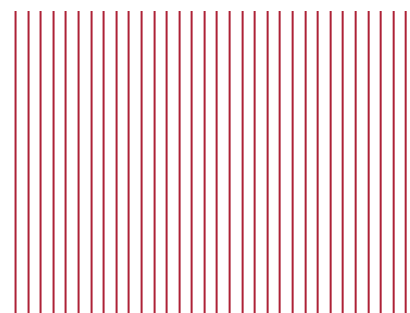

WD 426



WD 427

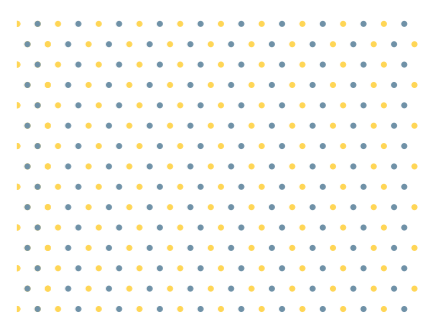

WD 428

DRESS IMAGE

LETTERING

Archivio Tumidei delle immagini fotografiche.

Tumidei's library of photographic images.

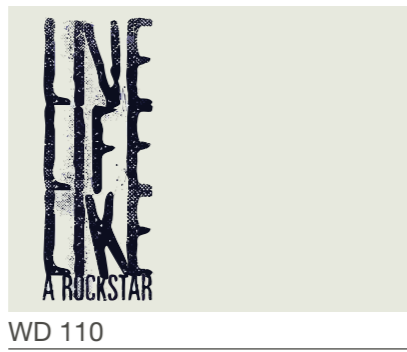

WD 110



WD 107

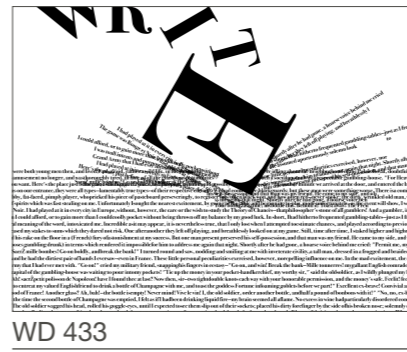

WD 433

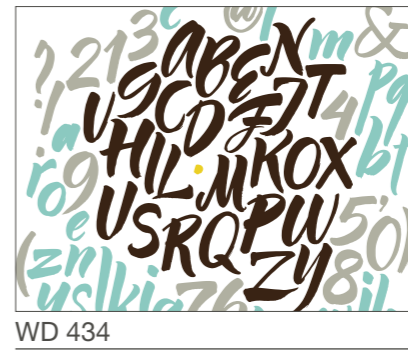

WD 434

ere in lui doti come il c
imale, cogi astute e brava e
riti dopo la brutta stagione
vgnare paesi lontani, bella
con una mia perfeta e, te
ribile animale che non e
il piu' velocemente possibile
inverificato, quando, due fra
molti affogandole il gano
e, per posto fino a quando i
L'risorante ruggito, poppi
contro con il bone, si sta
un'comodissime quando ch
colaggio e l'infellegge, i
bravo cacciatori, avrebbe fr

WD 435

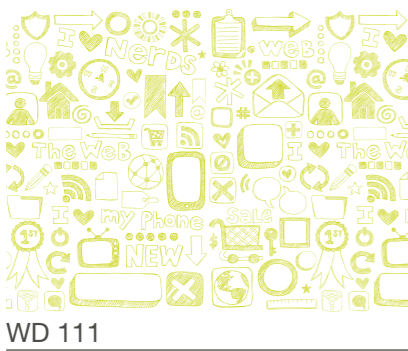

WD 111

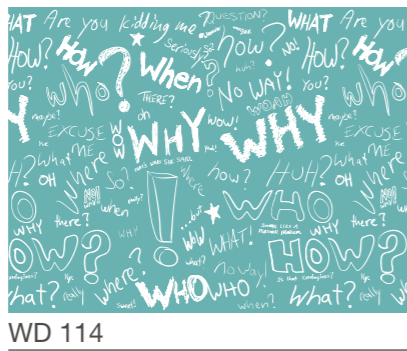

WD 114



WD 117

DRESS IMAGE

STREET

Archivio Tumidei delle immagini fotografiche.

Tumidei's library of photographic images.



WD 122



WD 127F

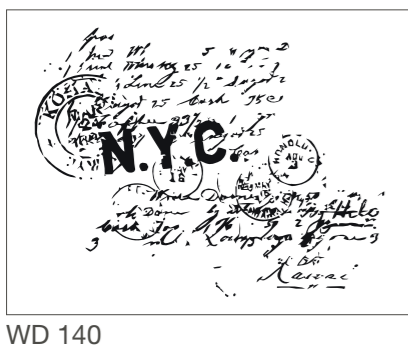

WD 140



WD 163



WD 209



WD 127



WD 134



WD 225

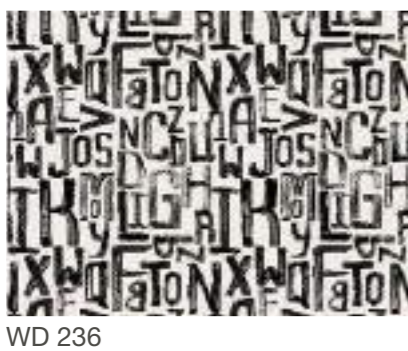

WD 236



WD 277



WD 429



WD 241



WD 245



WD 246



WD 430

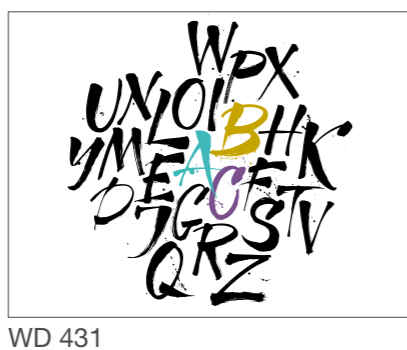

WD 431



WD 432



WD 247



WD 248



WD 253



WD 256



WD 275



WD 300



WD 441



WD 190



WD 301



WD 303



WD 304



WD 193



WD 196



WD 197



WD 306



WD 307



WD 308



WD 199



WD 200

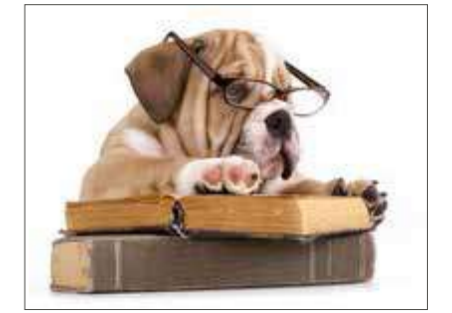

WD 205



WD 312



WD 436



WD 437

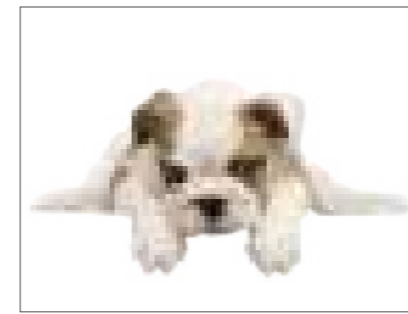

WD 208



WD 442



WD 443



WD 438



WD 439

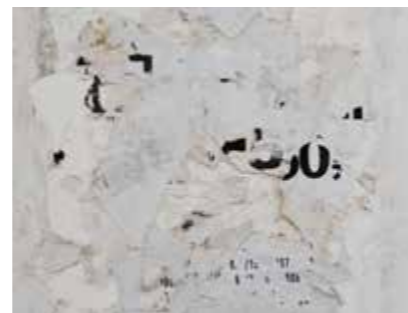

WD 440

DRESS IMAGE
COMICS
Archivio Tumidei delle
immagini fotografiche.
*Tumidei's library of
photographic images.*



WD 279



WD 280



WD 444



WD 445



WD 446

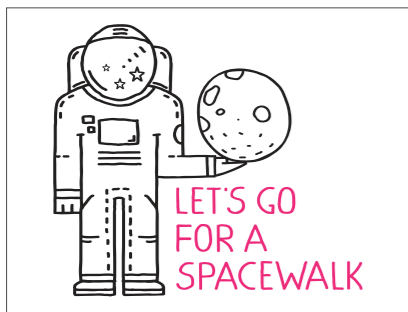

WD 447



WD 448



WD 449



WD 450



WD 451



WD 452

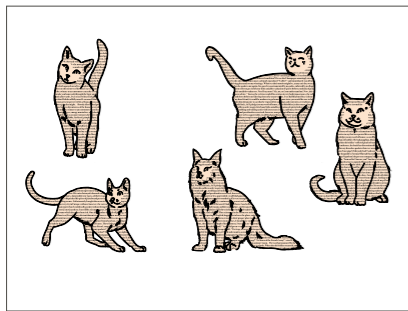

WD 453



DRESS IMAGE

TIK STAK

Adesivi removibili per pannelli.
Removable stickers for panels.



TIK 003



TIK 004



TIK 008

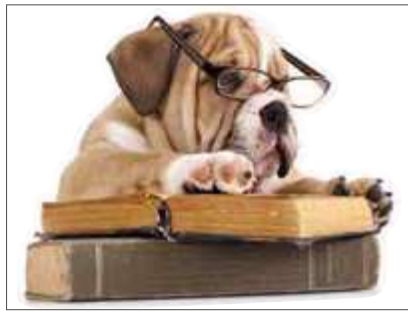

TIK 009

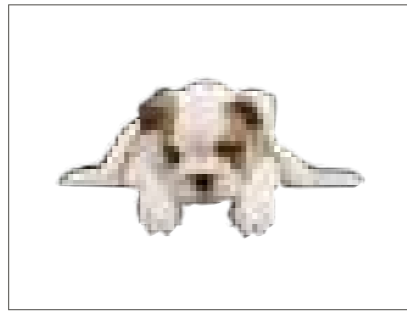

TIK 012



TIK 013

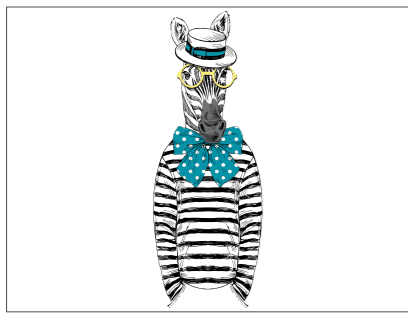

TIK 014



TIK 015

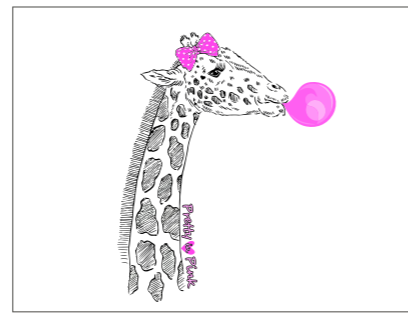

TIK 017

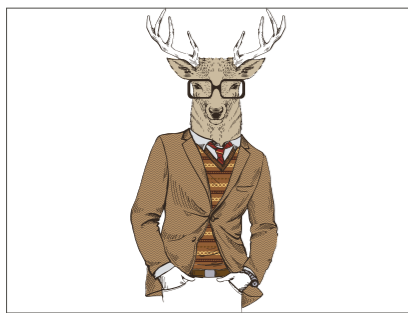

TIK 018

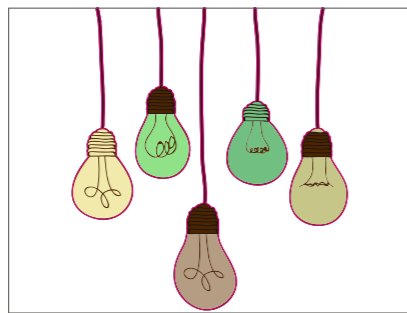

TIK 020



TIK 025



TIK 028

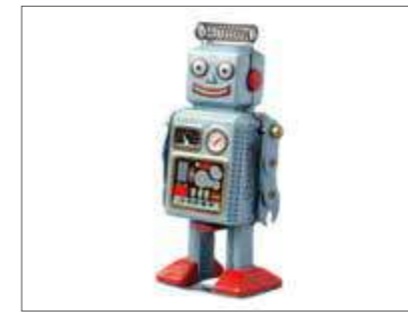

TIK 029

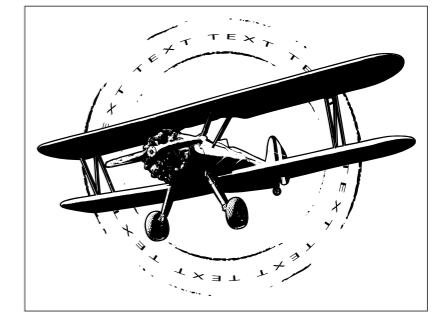

TIK 030

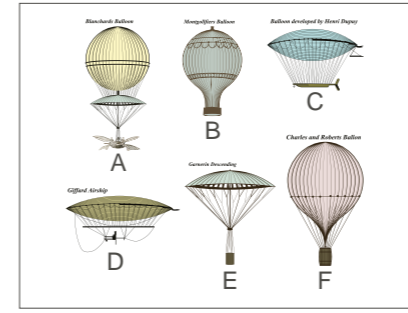

TIK 032 A/B/C/D/E/F



TIK 035



TIK 037



TIK 038 A/B/C

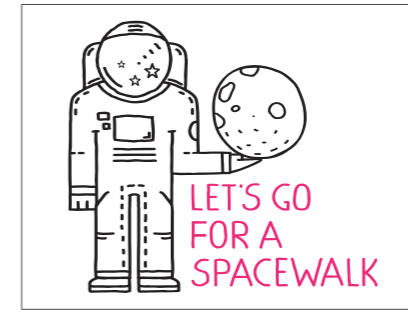

TIK 454



TIK 455



TIK 456



TIK 457

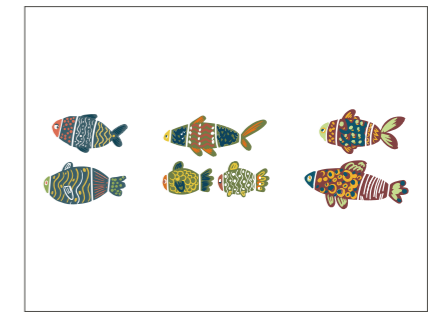

TIK 458

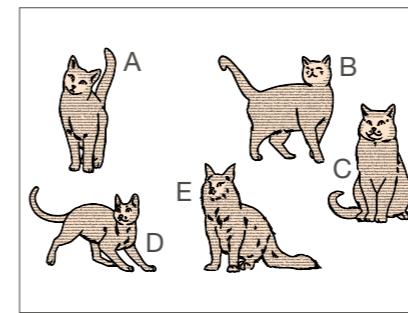

TIK 459 A/B/C/D/E

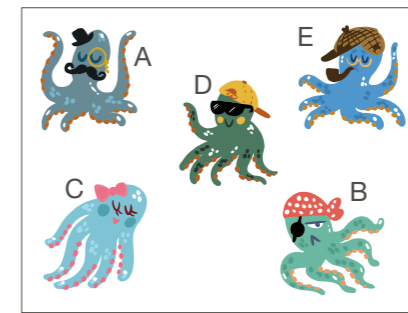

TIK 460 A/B/C/D/E

TESTATE
HEADBOARDS

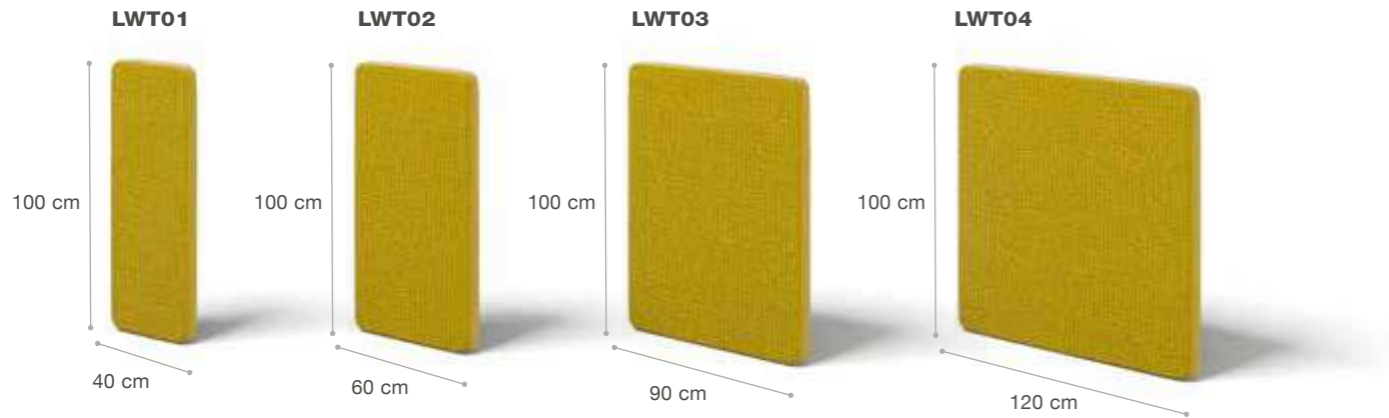

GIROLETTI
BEDFRAMES



Il sistema letto Tommy si compone da 4 diverse misure di testata, che si sviluppano in orizzontale e da 5 basi letto che assolvono in modo completo a tutte le esigenze di spazio e comfort. Tutte le testate e le basi letto sono interamente sfoderabili e intercambiabili. Le testate sono indipendenti fra loro e possono essere assemblate creando cadenze personalizzate, arricchite dai molti tessuti presenti nel catalogo Tumidei. La base letto è composta da un box "Sommier" per dare il massimo confort e da due piedi in fusione di alluminio, che possono essere personalizzati con tutta la gamma di laccature Tumidei o ricoprirsi in tessuto grazie al rivestimento del piede tessile.

The Tommy bed system is made up of 4 different sizes of headboards which expand horizontally and 5 bedframes which completely fulfill every space and comfort demand. All headboards and bedframes are completely removable and interchangeable. The headboards are self-standing and can be assembled creating custom-tailored compositions thanks to the range of fabrics available on Tumidei catalogue. The bed-base is composed by a "Sommier" box, which gives the maximum comfort, and by two aluminium feet, which can be personalized by using the range of Tumidei lacquered colours or they can be covered in fabric, thanks to the textile feet covering.

LWT21

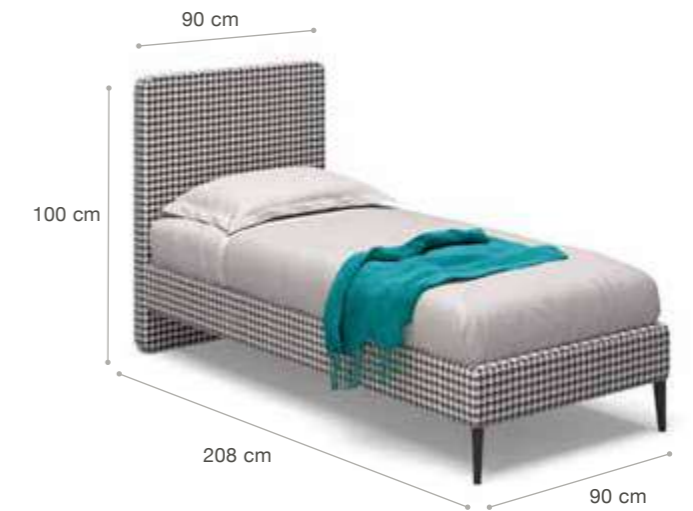

LWT22



LWT24



DIMENSIONE MATERASSO 90 / 120 / 140 / 160 / 180 X 200 CM
MATTRESS SIZE 90 / 120 / 140 / 160 / 180 X 200 CM

Disponibile nei tessuti della collezione Tumidei
Available in the fabrics of the Tumidei collection



**Piedino opzionale
/ Optional feet**



Piedino in tessuto
/ Feet in fabric



Piedino in alluminio
naturale o alluminio
laccato
/ Feet in natural or
lacquered aluminium

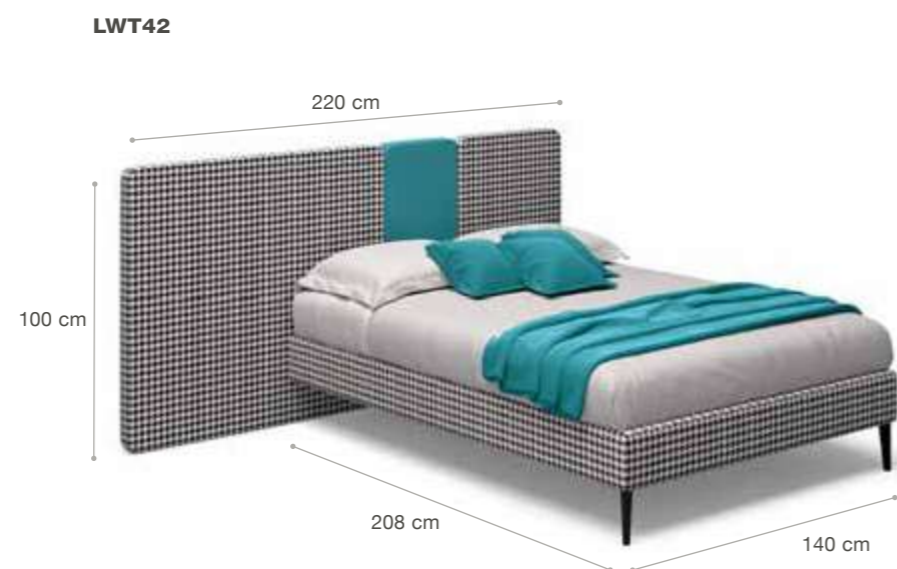
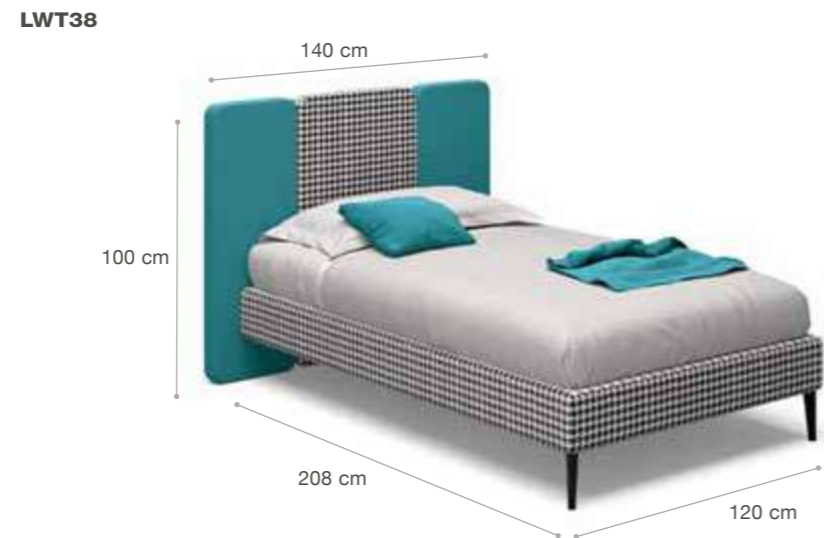

Testata e giroletto completamente sfoderabile con possibilità di cuciture a contrasto nei colori bianco, nero, rosso, azzurro, blu, beige. Colore Zip nera o rossa a richiesta.

Headboard and frame completely removable with chance of contrasting stitching in the following colours: white, black, red, blue, dark blue and beige. Zip available black or red on request.



Disponibile nei tessuti della collezione Tumidei
Available in the fabrics of the Tumidei collection

ROUND Bed system

LETTO CON RETE A DOGHE FISSA
BED WITH FIXED SLATTED BASE

I letti Round sono caratterizzati da 4 forme di testata (tipo A-B-C-D) e dai piedi frontali rientranti.
Le finiture dei letti Round possono essere laccate, in nobilitato o stampa digitale per tutti i tipi di testata.
I letti Round imbottiti, sono disponibili solo per le testate di tipo A o B.

The Round beds are characterized by 4 different headboard shapes (A-B-C-D type) and by front backward feet.
The finishes of Round beds can be in lacquered, in melamine or with digital print for every type of headboard.
The upholstered Round beds are available only for headboards type A and B.

LER03 Testata / Headboard A



LER05 Testata / Headboard D



LER01 Testata / Headboard B



LER34 Testata / Headboard A



LER07 Testata / Headboard C



LER32 Testata / Headboard B



Testata e giroletto completamente sfoderabile.
Finitura cordoncino a contrasto in 7 colori della collezione tessuti Tumidei.

Headboard and frame completely removable.
Contrasting piping in 7 colours of Tumidei collection.

■ ■ Disponibile in laccato o nobilitato nei colori della gamma Tumidei
Available in lacquered or melamine in Tumidei range of colours

■ Disponibile nei tessuti della collezione Tumidei
Available in all the fabrics of the Tumidei collection

DIMENSIONE MATERASSO 90 / 115 X 200 CM
MATTRESS SIZE 90 / 115 X 200 CM

SYSTEM STAR



Piedino opzionale
/ Optional Feet

RT42



LW12X

Alcuni esempi
/ Some examples



LW08X



LETTO CON RETE A DOGHE FISSA
BED WITH FIXED SLATTED BASE

LETTO APRIBILE CON CONTENITORE
BED WITH OPENING STORAGE UNIT

Il letto system Star è disponibile nelle finiture, laccato e nobilitato nei colori a campionario, oppure imbottito con rivestimento in tutti tessuti presenti nella collezione Tumidei.

The System Star bed is available in all lacquered and melamine finishes in all the colours of the Tumidei samples range, or upholstered with all the fabrics from the Tumidei collection.

LW10X



LH03X



LH23X



■ Disponibile in laccato o nobilitato nei colori della gamma Tumidei
Available in lacquered or melamine in Tumidei range of colours

■ Disponibile nei tessuti della collezione Tumidei
Available in all the fabrics of the Tumidei collection

DIMENSIONE MATERASSO 90 / 120 X 200 CM
MATTRESS SIZE 90 / 120 X 200 CM

SYSTEM SCRIGNO



LW42X

Alcuni esempi
/ Some examples



LW48X



■ ■ Disponibile in laccato o nobilitato nei colori della gamma Tumidei
Available in lacquered or melamine in Tumidei range of colours

■ Disponibile nei tessuti della collezione Tumidei
Available in all the fabrics of the Tumidei collection

LETTO CON RETE A DOGHE FISSA
BED WITH FIXED SLATTED BASE

LETTO APRIBILE CON CONTENITORE
BED WITH OPENING STORAGE UNIT

LETTO CON RETE SINGOLA ESTRAIBILE
BED WITH SINGLE PULL-OUT BASE

Il letto system Scrigno è disponibile nelle finiture, laccato e nobilitato nei colori a campionario, oppure imbottito con rivestimento in tutti tessuti presenti nella collezione Tumidei.

The System Scrigno bed is available in all lacquered and melamine finishes, in all the colours of the Tumidei samples range, or upholstered with all the fabrics of the Tumidei collection.

LH38X



LX80X + LK83X



LK83X

Dimensione materasso letto estraibile 85 x 195 cm
Size of the pull-out bed mattress 85 x 195 cm

LW56X



DIMENSIONE MATERASSO 90 / 120 X 200 CM
MATTRESS SIZE 90 / 120 X 200 CM

LORY Beds

LETTI SCORREVOLI CON RETE A DOGHE E PIANO SCRITTOIO SLIDING BEDS WITH WOODEN SLATS AND WRITING DESK

Il letto Lory con secondo letto estraibile o scrittoio sovrapponibile è disponibile nelle finiture, laccato e nobilitato nei colori a campionario della collezione Tumidei.

The Lory bed with a second pull-out bed or overlapping writing desk is available in all lacquered and melamine finishes, in all the colours of the Tumidei samples range.

Dimensione materasso 90 x 190 cm
Mattress size 90 x 190 cm

LR36



LR36 + LR37



LR37

Dimensione materasso 90 x 200 cm
Mattress size 90 x 200 cm

LR36

Dimensione materasso 90 x 190 cm
Mattress size 90 x 190 cm

LR36 + LR38



LR36

Dimensione materasso 90 x 190 cm
Mattress size 90 x 190 cm

LR38

Scrittoio disponibile solo nella finitura nobilitato

Writing desk available only in melamine finish

Disponibile in laccato o nobilitato nei colori della gamma Tumidei
Available in lacquered or melamine in Tumidei range of colours

Disponibile nei tessuti della collezione Tumidei
Available in all the fabrics of the Tumidei collection

TEO Beds

LETTO SINGOLO CON PIEDI TORNITI IN FRASSINO NATURALE SINGLE BED WITH TURNED FEET IN NATURAL ASH

Il letto Teo è disponibile nelle finiture, laccato o nobilitato in tutti i colori a campionario. Il poggiatesta è in tessuto nei colori della collezione Tumidei.

The Teo bed is available in all lacquered and melamine finishes, in all the colours of the Tumidei samples range. The headboard is available in fabric in the colours of the Tumidei collection.

Dimensione materasso 90 x 195 cm
Mattress size 90 x 195 cm

LX01 + TE28



LX02 + TE28



Dimensione materasso 90 x 195 cm
Mattress size 90 x 195 cm

Il letto Evo è disponibile nelle finiture, laccato e nobilitato nei colori a campionario. Il fronte delle testate può essere personalizzato con la grande collezione di grafiche presenti nel catalogo, oppure imbottito con rivestimento sfoderabile in tutti i tessuti presenti nella collezione Tumidei.

The Evo bed is available in all lacquered and melamine finishes, in all the colours of the Tumidei samples range. The front part of the headboards can be customized with the great collection of graphics present in the Tumidei catalogue, otherwise it can be upholstered with a removable covering available in all the Tumidei fabrics.

LE05X



LE75X



LE75X + CU86



Piedino opzionale / Optional Feet

GM31 Ø 5 cm



GH31 5x5 cm



GR31 8x8 cm



GT31 8x8 cm



GL86 Unidirezionale / One-Way



GL87 Girevole / Rotating



LE21X



LE73X



LE74X



■ Disponibile in laccato o nobilitato nei colori della gamma Tumidei
Available in lacquered or melamine in Tumidei range of colours

■ Disponibile nei tessuti della collezione Tumidei
Available in all the fabrics of the Tumidei collection

DIMENSIONE MATERASSO 95 / 115 X 200 CM
MATTRESS SIZE 95 / 115 X 200 CM

EVO SOFT Upholstered Beds

LETTO IMBOTTITO SFODERABILE CON RETE A DOGHE E PIEDE GM31
UPHOLSTERED AND REMOVABLE BED WITH SLATTED BASE AND FOOT GM31

Il letto Evo con testata e giroletto imbottito sfoderabile è disponibile in tutti i tessuti presenti nella collezione Tumidei.

The Evo bed with upholstered headboard and frame is available in all the fabrics of the Tumidei collection.

LD71X



LD68X



È possibile eseguire una cucitura in contrasto con filo dei seguenti colori:

It is possible to realize a relief stitching with yarn in the following colours:

- 000
- 22
- 14
- 114
- 48
- 9

LD72X



LD69X



LD70X



LD70X
Dimensione materasso
155 x 200 cm
Mattress size
155 x 200 cm

Disponibile nei tessuti della collezione Tumidei
Available in the fabrics of the Tumidei collection

DIMENSIONE MATERASSO 95 / 115 X 200 CM
MATTRESS SIZE 95 / 115 X 200 CM

LB38X



LB31



LCM13



LB23X



LCM18



Piedino opzionale / Optional Feet

GT61 8x8 cm



GR61 8x8 cm



GL80



GL81



LCM04



Il letto Comfort è disponibile nelle finiture, laccato e nobilitato nei colori a campionario, piano rete solo in nobilitato oppure imbottito con rivestimento in tutti tessuti presenti nella collezione Tumidei.
Il fronte delle testate può essere personalizzato con la grande collezione di grafiche presenti nel catalogo Tumidei.

The Comfort bed is available in all lacquered and melamine finishes, in all the colours of the Tumidei samples range, or upholstered with all the fabrics of the Tumidei collection.
The front part of the headboards can be customized with the great collection of graphics present in Tumidei catalogue.

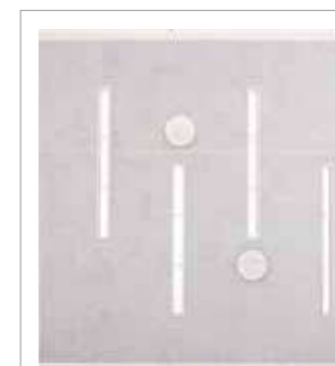

Dettaglio PIANO RETE con tagli che consentono una traspirazione del materasso e dischi antiscivolo. In finitura solo nobilitato.

BED BASE detail with holes which allow the transpiration of the mattress and nonslip rubbers. The slatted base is available in melamine only.



DIMENSIONE MATERASSO 90 / 115 X 195 CM
MATTRESS SIZE 90 / 115 X 195 CM

LCM21



LCM02



Disponibile in laccato o nobilitato nei colori della gamma Tumidei
Available in lacquered or melamine in the Tumidei range of colours

COMFORT Beds

LETTO CON TRAFILA ALLUMINIO E PIEDE GT61
BED WITH ALUMINIUM PROFILES AND FOOT GT61

Il letto Comfort è disponibile con trafila in alluminio nelle finiture a campionario e testata imbottita rivestita in tutti tessuti presenti nella collezione Tumidei.

The Comfort bed is available with aluminum profiles in all the finishes of the samples range and with upholstered headboard covered in all the fabrics of the Tumidei collection.

LB41



LB45

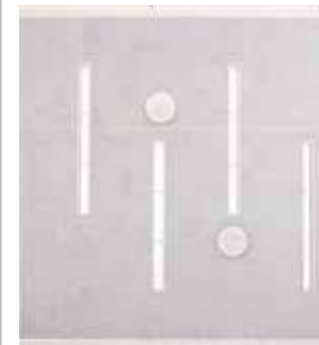

Dettaglio PIANO RETE con tagli che consentono una traspirazione del materasso e dischi antiscivolo. In finitura solo nobilitato.

BED BASE detail with holes which allow the transpiration of the mattress and nonslip rubbers. The slatted base is available in melamine only.



LB43



LB46



LB47



LB48



Disponibile nei tessuti della collezione Tumidei
Available in the fabrics of the Tumidei collection

DIMENSIONE MATERASSO 90 / 115 X 195 CM
MATTRESS SIZE 90 / 115 X 195 CM

Il letto Big con secondo letto estraibile o cassetti, è disponibile nelle finiture, laccato e nobilitato dei colori a campionario della collezione Tumidei.

The Big Bed with a second pull-out bed or drawers is available in all lacquered and melamine finishes, in all the colours of the Tumidei samples range.

LR32



LR31 + LR32



LR31



LR32
Dimensione materasso 85 x 190 cm
Mattress size 85 x 190 cm

LR31
Dimensione materasso 85 x 200 cm
Mattress size 85 x 200 cm

LR35



LR35
Dimensione materasso 85 x 190 cm
Mattress size 85 x 190 cm

LR31 + LR35



LR32 + LK53



LK53
Dimensione materasso letto estraibile 80 x 190 cm
Size of pull-out bed mattress 80 x 190 cm

LR32 + LR31 + LK53



Disponibile in laccato o nobilitato nei colori della gamma Tumidei
Available in lacquered or melamine in the Tumidei range of colours

PIANI SAGOMATI E SCRITTOI

SHAPED TOPS AND WRITING DESKS

TRAFILA LINEARE / Linear profiles

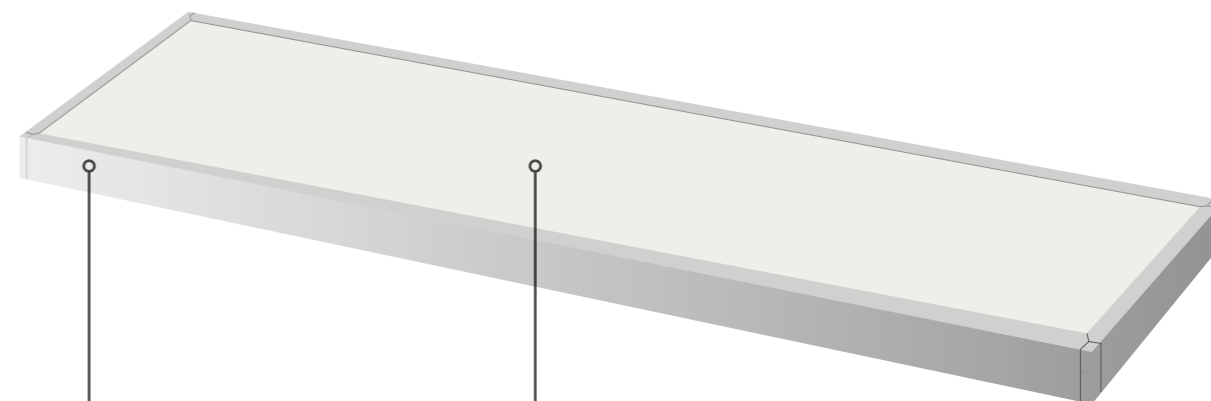

Modello Brevettato Depositato
Registered Patented Model

FINITURA TRAFILA
/ PROFILES FINISH

FINITURA PIANI
/ TOP FINISH

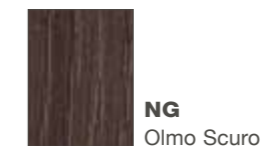
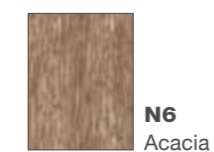
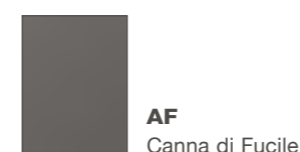
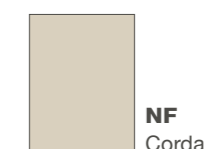
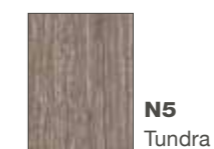
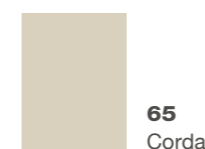
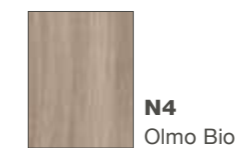
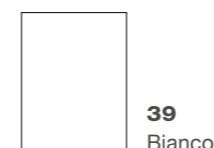

TRAFILA LINEARE / Linear profiles

- TAGLIO SU MISURA LETTI,
SOPPALCHI E SCRITTOI
- CUSTOM-CUT FOR BEDS,
MEZZANINES AND WRITING DESKS

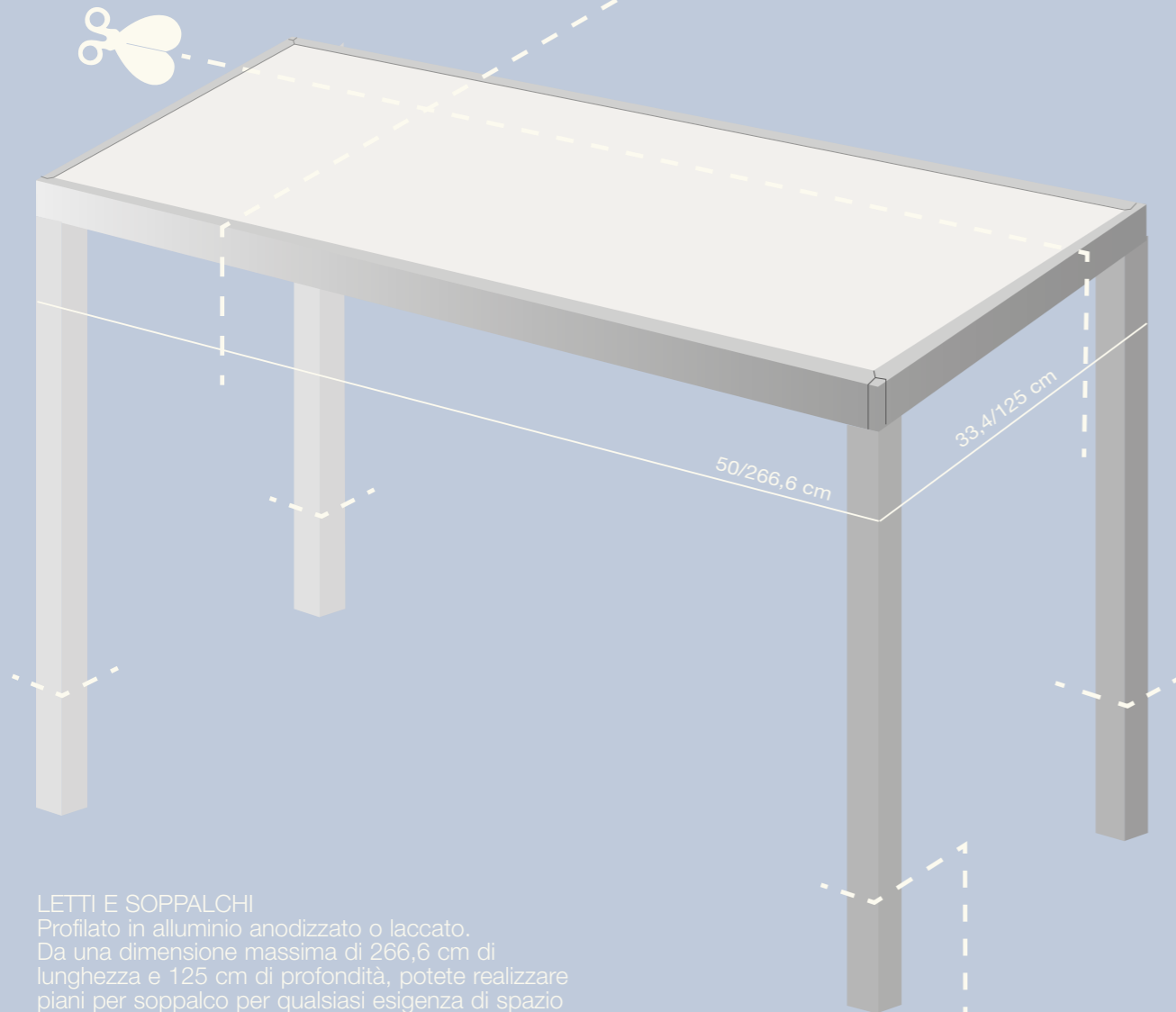

LETTI E SOPPALCHI
Profilato in alluminio anodizzato o laccato.
Da una dimensione massima di 266,6 cm di
lunghezza e 125 cm di profondità, potete realizzare
piani per soppalco per qualsiasi esigenza di spazio
e di funzione.

BEDS AND MEZZANINES
Anodized aluminium or lacquered.
Starting from a maximum size of 266,6 cm length and
125 cm depth, to realize mezzanine tops for any space
and functional requirement.

TUBI 8x8 cm CON TAGLIO SU
MISURA IN ALTEZZA

TUBES 8x8 cm WITH
CUSTOM-HEIGHT

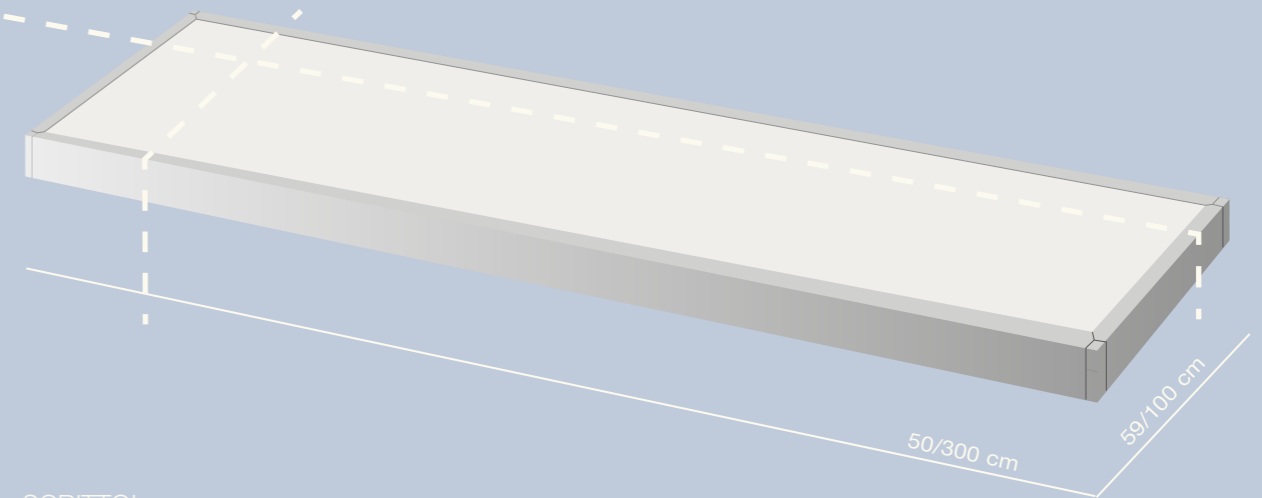

SCRITTOI
Profilato in alluminio anodizzato o laccato.
Da una dimensione massima di 300 cm
di lunghezza e 59 /100 cm di profondità,
potete realizzare piani scrittoio per
qualsiasi esigenza di spazio e di funzione.

WRITING DESKS
Anodized aluminium or lacquered.
Starting from a maximum size of 300
cm length and 59 or 100 cm in depth
you can realize writing desks for all
functional and space requirements.

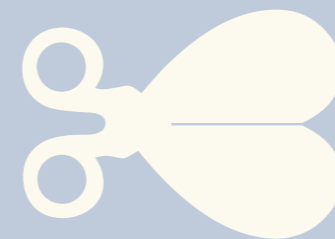

taglio al millimetro

PIANI SAGOMATI 2,8 cm - 4 cm

PIANI SAGOMATI A DISEGNO
SHAPED TOPS AS PER DRAWING

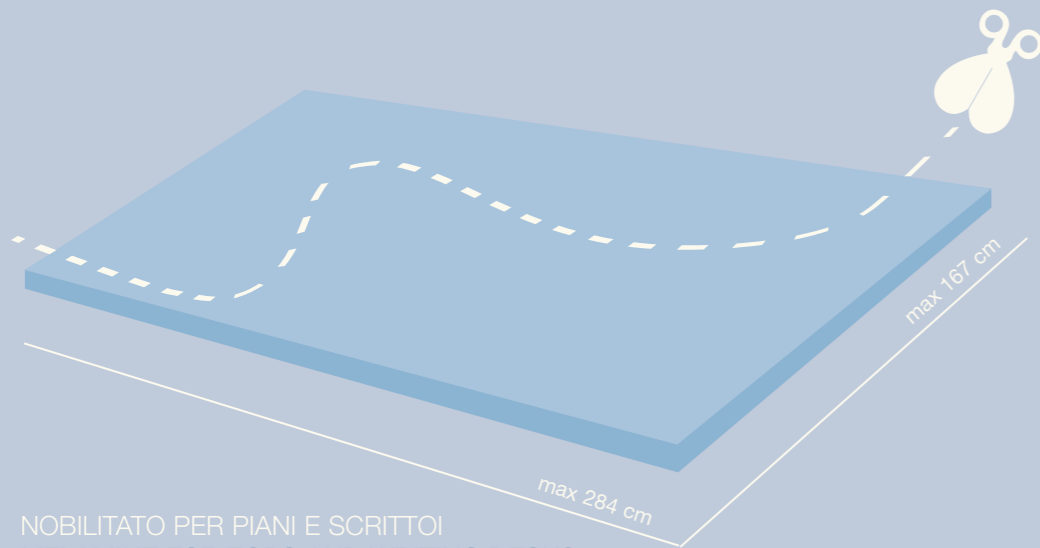

NOBILITATO PER PIANI E SCRITTOI
MELAMINE FOR TOPS AND WRITING DESKS

Raggio minimo interno ed esterno 5 cm.
In and out minimal radius 5 cm.

MENSOLE SAGOMATE 2,8 cm

MENSOLE SAGOMATE A DISEGNO
SHAPED SHELVES AS PER DRAWING

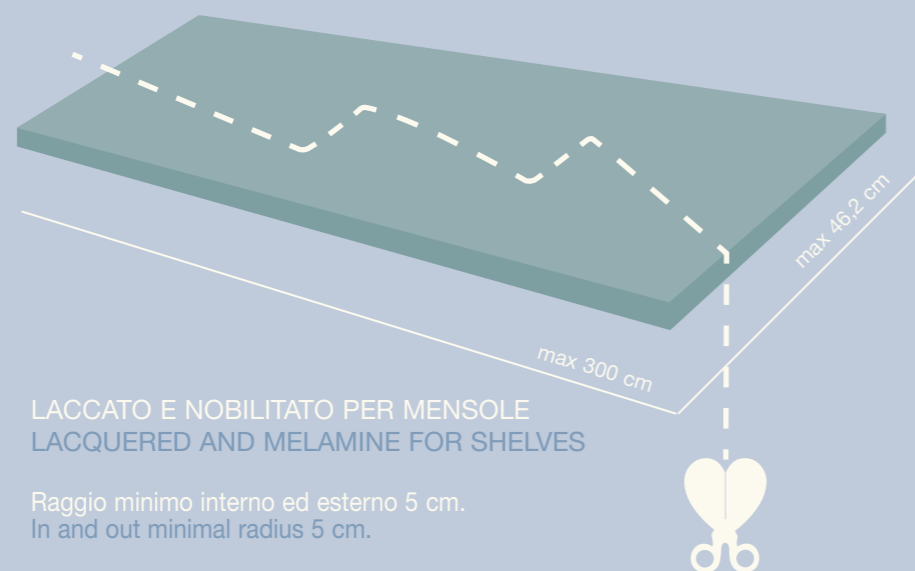

LACCATO E NOBILITATO PER MENSOLE
LACQUERED AND MELAMINE FOR SHELVES

Raggio minimo interno ed esterno 5 cm.
In and out minimal radius 5 cm.

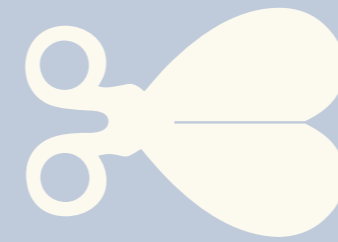

taglio su disegno

TESTATE SAGOMATE 2 - 4 cm

TESTATE PER LETTI SAGOMATE A DISEGNO
SHAPED HEADBOARDS AS PER DRAWING

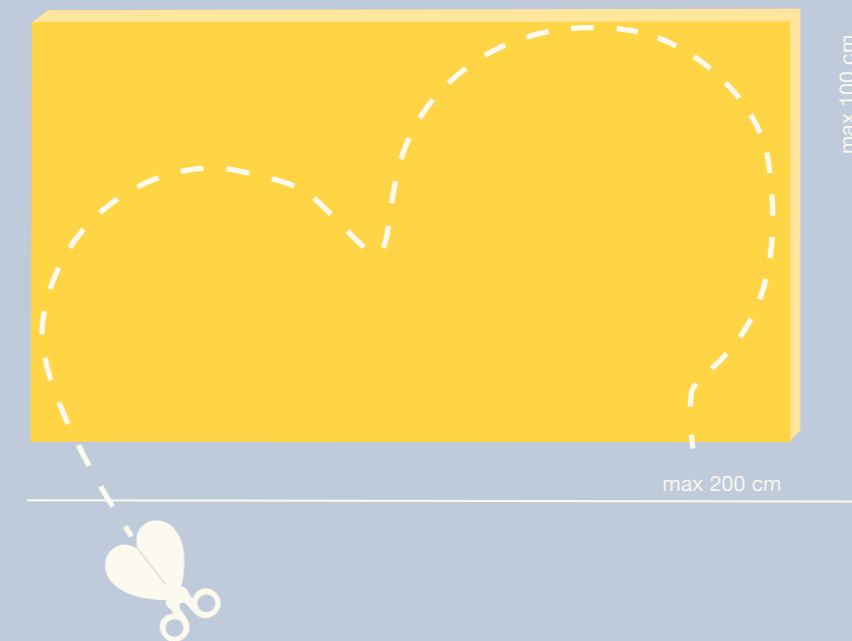

LACCATO E NOBILITATO PER TESTATE
LACQUERED AND MELAMINE FOR HEADBOARDS

Raggio minimo interno ed esterno 5 cm.
In and out minimal radius 5 cm.

SQUARE / Desk



TQA65
L 133,4 cm P 59,2 cm H 77,2 cm



TQA62
L 133,4 cm P 59,2 cm H 77,2 cm

SCRITTOIO SCORREVOLE SU GUIDA SLIDING DESK ON RAIL



TQA68
L 133,4 cm P 59,2 cm H 77,2 cm

Square è una struttura di sostegno in metallo per piani e scrittoi, caratterizzata da un blocco centrale che diventa un pratico contenitore, discreto e funzionale.

Può essere utilizzato come terminale di una scrivania o composto in varie configurazioni per creare tavoli e scrivanie, dotato di ruote per la configurazione con le barre scorrevoli del sistema Tiramolla oppure con piedi antiscivolo per i tavoli freestanding.

Square può essere laccato in tutti i colori della gamma Tumidei. Piani scrittoria sempre in nobilitato.

Square is a metal supporting structure for tops and writing desks, characterized by a central unit which turns into a practical, functional and discreet storage unit. It can be used as a desk terminal or it can be composed in many configurations to create tables and desktops. It can be equipped with castors for the configuration with the Tiramolla sliding rails system or with non-slip feet for self-standing tables.

Square can be lacquered in all the colors of the Tumidei collection whereas the writing desk is available in melamine only.

SEDIE / Chairs

Una collezione di sedute disponibili con ruote o fisse, personalizzabili con tutti in tutti colori laccati e tessuti disponibili nella collezione Tumidei.

A collection of chairs available with adjustable legs or castors equipped, customizable with all the lacquered colours and fabrics of the Tumidei collection.



SE72 + SE79



SE10



SE24



SE76 + SE79



Pannello con collegamenti USB e alimentazione di rete
Panel with USB ports and power supply



TC01



TC02

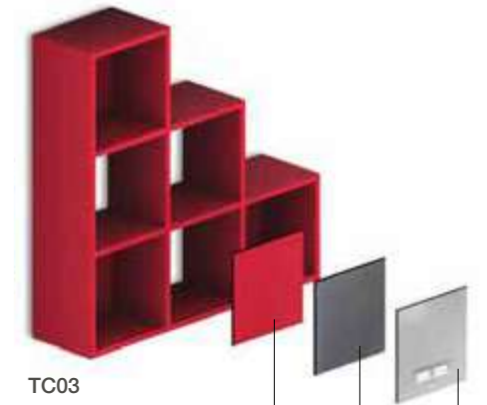

TC03

TC06
Schiena
Back

TC07
Copridiffusore
Loud speaker cover

TC08
Pannello con collegamenti USB
e alimentazione di rete
Panel with USB
ports and power supply

3 MODULI,
INFINITE
COMBINAZIONI

La parola CLOUD è ormai un elemento costante in ogni momento tecnologico della vita di tutti i giorni, la nuvola consente di raggruppare funzioni e contenuti. T-CLOUD è un sistema di contenitori parete, che grazie alla loro semplicità consente di ospitare e fornire servizi a molte delle funzioni che caratterizzano l'abitare di oggi: dalla musica, ai dati, alla ricarica di un device qualsiasi, al semplice contenimento di oggetti, il sistema infatti integra con intelligenza connessioni USB e alimentazioni di rete.

La semplicità è alla base del brief di progetto, il sistema è infatti costituito da soli tre componenti, tre nuvole, che combinandosi consentono di offrire molteplici combinazioni, inoltre è possibile sia il fissaggio a filo muro che distanziato per il passaggio ed occultamento dei cavi. Il sistema si integra al programma di contenitori di Tumidei sia per l'area giorno che per la cameretta, acquisendone colori finiture e materiali.

3 MODULES,
ENDLESS
COMBINATIONS

The word CLOUD is a constant element in any technological moment of everyday life. It allows to group functions and contents. T-CLOUD is a system of wall storageboxes which, thanks to their simplicity, allows to provide with services to many functions making up the current way of life: music, data, recharge of any device, storage of object. In fact, the system brightly combines USB ports with power supplies.

The simplicity underlies the design brief, in fact the system is composed by only three components, three clouds which, once combined, are able to offer multiple combinations. In addition to that, it is possible to fix it directly to the wall or with a spacer behind to run and hide cables. The system is integrated to the Tumidei's boxes program for both living area and bedrooms, with the same colours, finishing and materials.



Copridiffusore
Audio speaker cover

ROUND / Collection

DESIGN BY SIMONE CAGNAZZO

ROUND PENSILI / ROUND WALL UNITS



CSL73
L 738 cm P 38,5 cm H 123,7 cm



CSL72
L 103 cm P 38,5 cm H 73,8 cm



CSL71
L 73,8 cm P 38,5 cm H 73,8 cm

Il sistema di contenitori Round, se posizionati uno accanto all'altro, creano diverse combinazioni, colorate e divertenti, pensati per uno spazio aperto e multifunzionale. La particolare anta stondata, oltre a fungere da maniglia rende i complementi morbidi e privi di spigoli, questo attribuisce una sicurezza maggiore nell'ambito delle camere per ragazzi. La collezione, si compone di piccole madie, cassettiere e pensili, in tre differenti forme, sono disponibili in laccato o nobilitato in tutti i colori a campionario. Il fronte delle ante può essere personalizzato con la grande collezione di grafiche presenti nel catalogo Tumidei.

Thanks to the Round system, the boxes can be positioned one next to the other to create different compositions, colorful and pleasant, for an open and multifunctional space. The particular rounded door, not only can be used as a handle, but it makes the structure smooth and with no edges, realizing a safer youngster's bedroom. The collection is composed by small cupboards, dressers and wall units, in three different shapes which are available in lacquered or melamine colours of the Tumidei collection. The front part of the doors can be customized by using the great range of graphics present in the Tumidei catalogue.



CSL61
L 73,8 cm P 46,2 cm H 74,7 cm



CSL62
L 103 cm P 46,2 cm H 74,7 cm



CSL63
L 73,8 cm P 46,2 cm H 124,6 cm



CSL65
L 73,8 cm P 46,2 cm H 74,7 cm



CSL66
L 103 cm P 46,2 cm H 74,7 cm



CSL67
L 73,8 cm P 46,2 cm H 124,6 cm



CSL64
L 53 cm P 38,5 cm H 57,2 cm

VIBE / Pouff

DESIGN BY SIMONE CAGNAZZO

Il pouff Vibe è disponibile in tutti i tessuti della collezione TUMIDEI con cuciture a contrasto su richiesta. È dotato da un sistema audio controllabile da smartphone o lettore mp3, tramite la tecnologia Bluetooth, si può spostare nei vari ambienti della casa senza scollegare il device, perché dotato di un Battery Pack integrato.

Da solo può creare un punto di seduta di ascolto musicale, di gioco e di svago, dotato di un contenitore, a cui si accede sollevando la seduta, Vibe crea una piccola zona living ed un Hotspot in cui ascoltare musica, giocare e ricaricarsi.

The Vibe pouf is available in all the fabrics of the TUMIDEI collection with contrasting stitching on request. It has a sound system remotely manageable by smartphones or Mp3 players thanks to the Bluetooth technology. It can be moved into the different house rooms without disconnecting any device because it is provided with an integrated Battery Pack.

As it can be a place to sit, listen to music, play and destress, and with a storage unit under the seat, Vibe creates a small living area and a Hotspot for music, games and relax.

 Bluetooth



PUF11
L 60 cm P 60 cm H 45 cm



TETRIS / Air Purification System

Tetris è un innovativo sistema di purificazione naturale dell'aria per ambienti indoor.

Il sistema Tetris si basa sul principio del Fitorimediazione, una tecnologia che utilizza le piante per la mitigazione di inquinanti, presenti nel suolo, nell'acqua e nell'aria. La pianta nel sistema Tetris diventa un vero filtro, grazie alla presenza di microrganismi nell'apparato radicale è capace di metabolizzare gli agenti nocivi presenti nell'aria. Attraverso una ventilazione meccanica forzata il sistema aumenta il flusso d'aria all'interno della pianta e ne amplifica l'efficacia in modo esponenziale.

Un vaso smart, capace di connettersi attraverso Wi-Fi ai comuni devices e gestibile attraverso un applicativo mobile. Tetris garantisce un'esperienza d'uso real-time, attraverso l'App l'utente è in grado di: Monitorare la reale presenza di agenti inquinanti nell'aria che si sta respirando; Programmare l'accensione e lo spegnimento a seconda del livello di inquinanti rilevati; Monitorare il livello di temperatura e umidità, parametri fondamentali al fine di garantire un buon comfort ambientale. E disponibile in tutti i laccati della gamma Tumidei, nella versione con o senza piedini.

Tetris is an advanced natural air purification system for indoor spaces.

The Tetris system is based on the fundamentals of the phytoremediation, a technology that uses plants for the mitigation of pollutants in soil, water and air. The plant inside the Itair system becomes a real filter, and thanks to the microorganisms in the roots, it is able to process the harmful agents present in the air.

Through a mechanical forced ventilation system, it increases the air flow inside the plant and it exponentially amplifies the effectiveness.

A smart vase, able to connect via Wi-Fi to the most common devices and manageable through a mobile application. Itair ensures a real-time user experience, thanks to the app the user can:

Monitor the real presence of contaminants in the air that you are breathing;

Program the turning on and off depending on the pollutants level measured.

Monitor the level of temperature and humidity, fundamental parameters in order to ensure a good environmental comfort.

It is available in the whole range of lacquered colours, and with or without legs.



TC72
L 42 cm P 45,5 cm H 73,8 cm



TC71
L 42 cm P 45,5 cm H 45,3 cm

MIRROR / Collection

DESIGN BY OVERDRIVE

Specchi in due dimensioni con possibilità di accoppiamento destro e sinistro. Possibilità di utilizzare le immagini dell'archivio MIRROR COLLECTION.

La stampa verrà applicata solo su pannello nobilitato.

Mirrors in two different sizes with right and left connection option. Chance of choosing among the images taken from Mirror Collection library. The print will be applied on the melamines panel only.

N.B.: le tonalità dei colori stampati possono differire leggermente dai toni dei colori del campionario.

NOTE: the colour shades printed may slightly differ from the ones of the samples range.

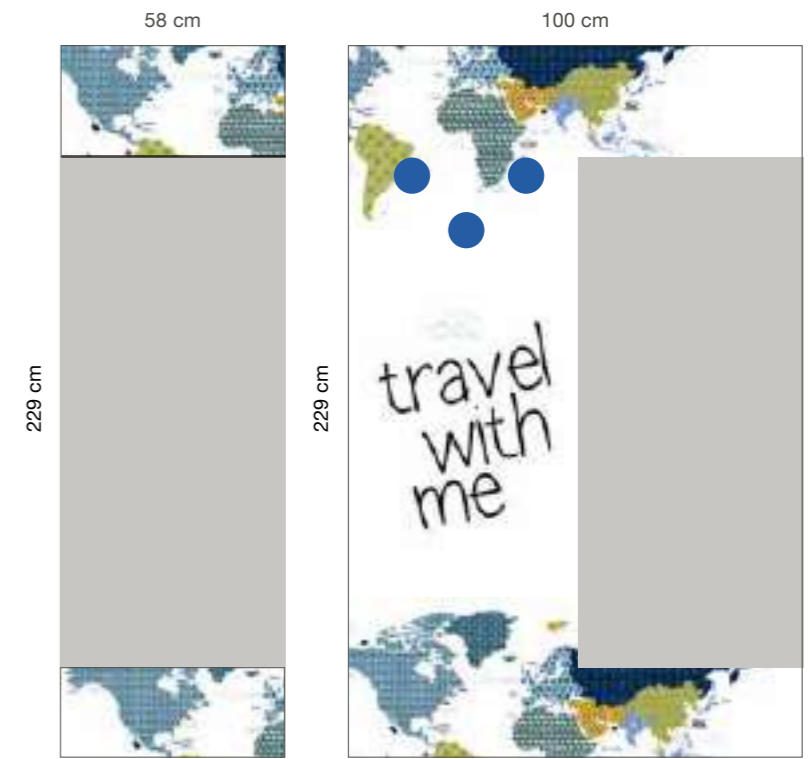

CUSTOM
Possibilità di personalizzazione della stampa partendo da un colore di campionario con scritte o elementi grafici.

CUSTOM
Chance of customizing the print starting from samples colours with writing or graphical elements.

SPAZIO 5 Boiserie con stampa digitale ed accessori.
SPAZIO 5 wall panels with digital print and accessories.

ARCHIVIO TUMIDEI MIRROR COLLECTION. TUMIDEI'S LIBRARY MIRROR COLLECTION.



CITY SCAPE

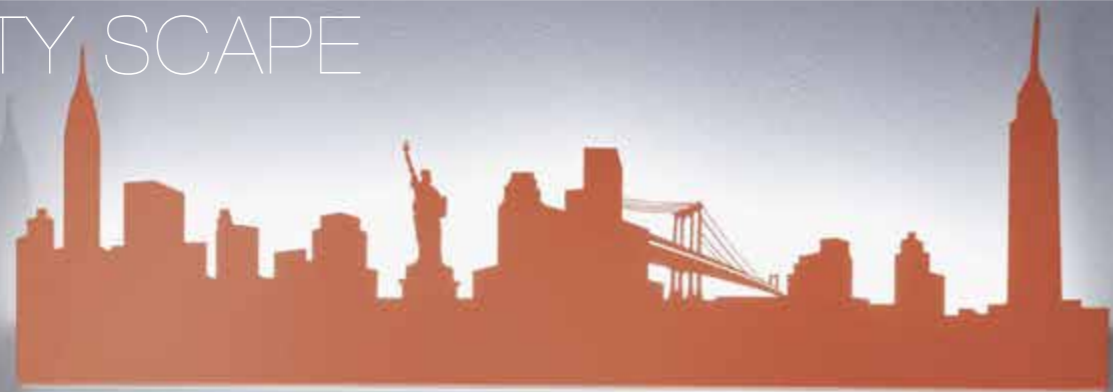

KR83 - New York



KR81 - Parigi



KR82 - Londra

“City Scape” sagome appendiabiti con luce realizzate in metallo e applicabili a muro in tutti i colori del campionario.

“City Scape” coat-hanger shapes with light made in metal and secured to the wall in all the colours of the samples range.



T-CLOCK / Collection

Nel programma Tiramolla anche gli accessori moltiplicano la loro funzione. Un esempio: l'orologio con ripiano in vetro si trasforma, all'occorrenza.

In the Tiramolla program even the accessories multiply their functions. An example: the clock with glass shelves can change itself when needed.



MP65N





DRIVE

DESIGN BY SIMONE CAGNAZZO



GUIDA A SCOMPARSA FUNZIONALE E LUMINOSA.
La guida di scorrimento per piani e letti "Drive" è un elemento decorativo e minimale, i meccanismi sono nascosti nella cover in alluminio personalizzabile in tutti i colori laccati della gamma Tumidei e può alloggiare uno strip Led RGB regolabile in remoto. Drive, non solo guida gli elementi della camera ma crea un' ambiente caldo e funzionale.

FUNCTIONAL AND LUMINOUS SLIDING RAIL.
The "Drive" rail for sliding tops and beds is a minimalistic decorative element. The mechanisms are concealed into the aluminum cover, which can be customized in all the lacquered colours of the Tumidei collection and can contain a Led RGB strip with remote control. Drive not only drives the bedroom elements, but it creates a warm and functional environment.

BLUETOOTH SOUND SYSTEM



IM81
Nel programma Tiramolla, le casse acustiche, sono integrate nella trafilata.
Il sistema Bluetooth, ne consente la connessione a tutti i devices.
Sono disponibili per il tubo con sezione 8x8 cm. e una misura minima in altezza di 70 cm, quindi inseribile anche nella struttura scrittoio.

In the Tiramolla program, the speakers are integrated in the profiles. The Bluetooth system allows the connection with all the devices. They are available for the tube with section 8X8 cm. and a minimum height of 70 cm, so they can be inserted in the writing desk structure too.



MANIGLIE / Handles

POMOLI E MANIGLIE IN LEGNO WOODEN KNOBS AND HANDLES



PM12L
Ø 2,4 cm



PX71
L 7 cm H 7 cm



PX18
L 6,2 cm P 2,5 cm H 5,5 cm



PX19
Ø 5 cm P 2,7 cm



PX35F (Frassino naturale - Natural Ash)
PX35L (Laccato a poro aperto - Open pore lacquered)
Ø 8 cm P 5 cm



PX36F (Frassino naturale - Natural Ash)
PX36L (Laccato a poro aperto - Open pore lacquered)
Ø 11 cm P 5 cm

POMOLI E MANIGLIE IN ALLUMINIO ALUMINIUM KNOBS AND HANDLES



PM12A
Ø 2,4 cm



PX22
L 3,2 cm P 1,6 cm



PX01
L 2,5 cm H 2,5 cm



PX02
L 7,4 cm H 2,5 cm



PX05
L 1,2 cm P 3,8 cm H 17 cm



PX04
L 1 cm P 3,2 cm H 7,4 cm

MANIGLIE AD INCASSO CON INSERTO RECESSED HANDLES WITH INSERT



PX25LL H 8 cm
PX26LL H 20 cm
PX27LL H 40 cm
PX28LL H 80 cm
PX29LL H 120 cm



PX25LN H 8 cm
PX26LN H 20 cm
PX27LN H 40 cm
PX28LN H 80 cm
PX29LN H 120 cm

Bordo laccato
Lacquered border

Fondo laccato
Lacquered back

Bordo laccato
Lacquered border

Fondo nobilitato
Melamine back

MANIGLIE AD INCASSO RECESSED HANDLES

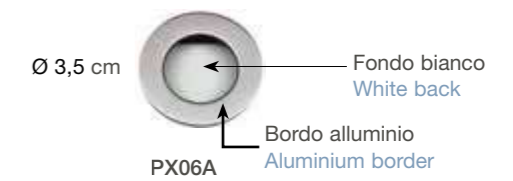

Ø 3,5 cm
Fondo bianco
White back
Bordo alluminio
Aluminium border

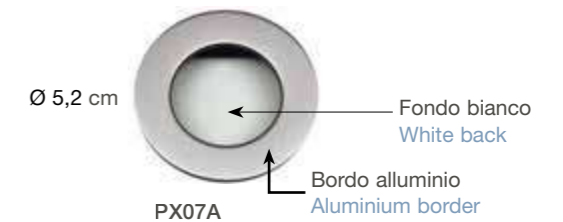

Ø 5,2 cm
Fondo bianco
White back
Bordo alluminio
Aluminium border

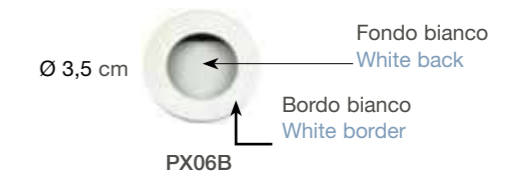

Ø 3,5 cm
Fondo bianco
White back
Bordo bianco
White border

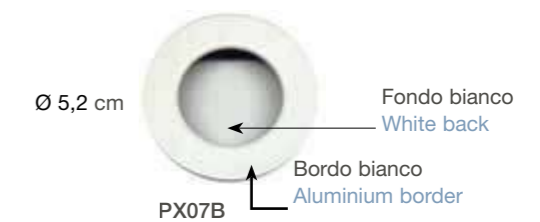

Ø 5,2 cm
Fondo bianco
White back
Bordo bianco
Aluminium border

MANIGLIE AD INCASSO IN METALLO METAL RECESSED HANDLES



PX73
L 5,5 cm H 5,5 cm



PX74
L 11 cm H 11 cm



PX08
L 5,2 cm H 5,2 cm



PX09
L 19,4 cm H 5,2 cm

MANIGLIE / Handles

MANIGLIE IN LEGNO E PVC WOODEN AND PVC HANDLES

PVC

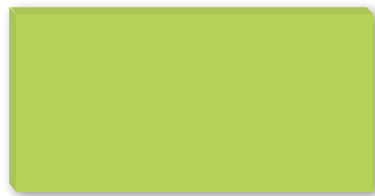

PX78
L 18 cm P 3,2 cm H 10 cm

Legno / Wood



PX77
L 5 cm P 3,2 cm H 5 cm

PVC

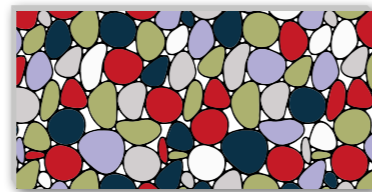

PX79
Immagine da archivio Tumidei
o immagine cliente.
Image from Tumidei's library
or from customer.

PVC



Laccato in tutti i colori
da campionario
Lacquered in all colours
of the samples

PX75
L 10 cm P 3,2 cm H 100 cm

PVC



Immagine da archivio
Tumidei o immagine cliente
Image from Tumidei's
library or from customer

PX76
L 10 cm P 3,2 cm H 100 cm

PVC

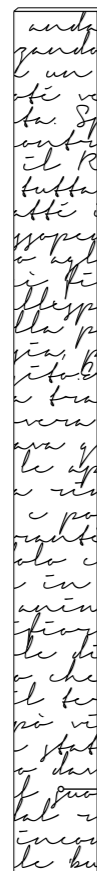

Possibilità di testo a piacere
nei vari colori del campionario
Text of your choosing in all
colours from samples range

PX76
L 10 cm P 3,2 cm H 100 cm

MANIGLIE IN LEGNO E ACCESSORI WOODEN HANDLES AND ACCESSORIES



PM41

- PM41** H 8 cm
- PM41B** H 20 cm
- PM42** H 33,8 cm
- PM43** H 48,6 cm
- PM44** H 84,4 cm



PM43

SIDE DESIGN BY SIMONE CAGNAZZO



PM67

- PM65** H 11 cm
- PM66** H 20 cm
- PM67** H 110 cm



PM66



PM65

SIDE
Orizzontale
Horizontal



PM66



PM65

SIDE
Verticale
Vertical



NZ48
Serratura ad asta
Rod lock



SR12
Serratura a cilindro
per cassetto
Cylinder lock for
drawer



PX68
L 4,2 cm H 6,5 cm
Gancio appendiabiti
Coat hanger hook

CODE / Handles

DESIGN BY SIMONE CAGNAZZO

SISTEMA FUNZIONALE E VERSATILE

La serie di maniglie Code, si sviluppano su tutto il profilo verticale dell'anta armadio, creando un gioco di pieni e vuoti, che dà carattere al sistema armadio. Sono disponibili in due differenti larghezze, possono essere personalizzate con le laccature della gamma Tumidei, in finitura specchio in tre diverse finiture, ed è possibile personalizzarle con la grande collezione di grafiche presenti nel catalogo Tumidei.

FUNCTIONAL AND VERSATILE SYSTEM

The set of Code handles expands throughout all the vertical profile of the wardrobe door, creating a trick of fullness and emptiness which gives personality to the entire wardrobe system. They are available in two different widths and can be customized with the Tumidei lacquered colours or using three different mirror finishes. In addition to that, it is possible to customize them with the great range of Tumidei graphics collection



PM63 L 12 cm H 227,1 cm
PM64 L 12 cm H 259,1 cm



PM61 L 20 cm H 227,1 cm
PM62 L 20 cm H 259,1 cm

FINITURE FINISHES



NOBILITATO
BIANCO
ANTRACITE
MELAMINES
WHITE
ANTRACITE

LACCATI OPACO
MATT LACQUERED

VETRO SPECCHIATO
BRONZO
GRIGIO
MIRRORED GLASS
BRONZE
GREY

VETRO RETRO
LACCATO
BACK
LACQUERED
GLASS

DRESS IMAGE
COLLECTION
WD 402
DECOR

ESEMPI DI COMPOSIZIONE EXAMPLES OF CONFIGURATION

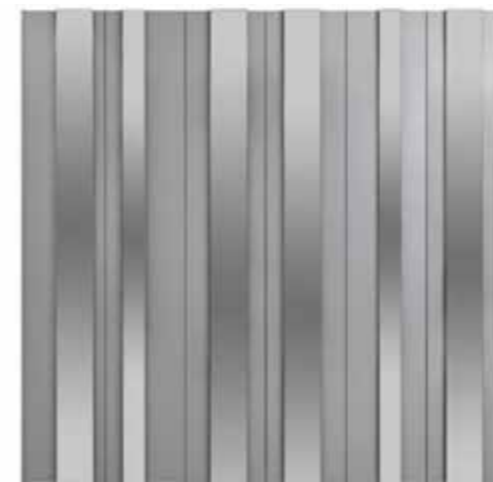

La maniglia Code può essere montata a 10 cm oppure a filo anta.
The Code handle can be assembled at 10 cm or on the door edge.

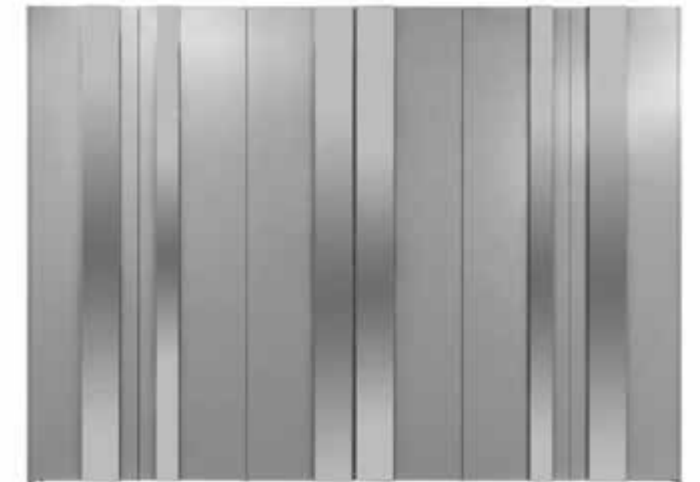

CODE / Handles

DESIGN BY SIMONE CAGNAZZO

Esempi di personalizzazione maniglia Code.
Example of Code handle customization.



DRESS IMAGE
COLLECTION
WD 403
DECOR



DRESS IMAGE
COLLECTION
WD 435
LETTERING

DRESS IMAGE / Collection

Le maniglie Code sono personalizzabili con la selezione di immagine tratte dalla collezione Dress Image.

The Code handles can be customized with the selection of images taken from the Dress Image collection.



WD 129



WD 132



WD 346



WD 352



WD 355

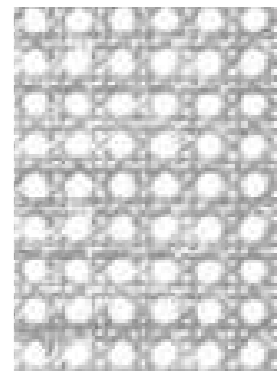

WD 400



WD 401



WD 402

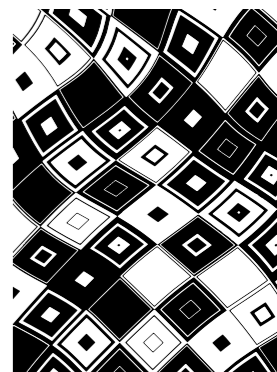

WD 403



WD 411

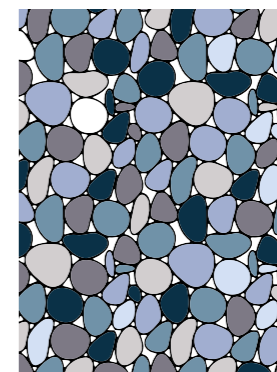

WD 422

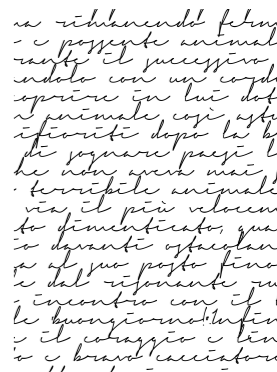

WD 435

La collezione Dress Image è una raccolta di immagini artistiche e stilizzate, ideata per personalizzare le maniglie Code. Le immagini sono tratte da diverse fonti, tra cui dipinti, fotografie e grafica digitale. La collezione è organizzata in modo da offrire una vasta gamma di scelte, dalle forme geometriche e astratte alle rappresentazioni di natura e animali. Le immagini sono disponibili in diverse versioni, adatte a diversi tipi di maniglie e a diverse dimensioni. La collezione Dress Image è una risorsa preziosa per chi desidera personalizzare le maniglie Code con un'immagine unica e significativa.

FINITURE / Finishes

LACCATO OPACO - VERNICI ALL'ACQUA / MATT LACQUERED - WATER-BASED PAINTS

43 Mandarino	69 Mustard Yellow	57 Melone	18 Yellow Rose	40 Sabbia	30 Rosa Delicata
83 Caramello	73 Verde Jungla	04 Verde Lime	03 Verde Tè	02 Verde Pastello	14 Cielo
10 Imola	79 Ribes	54 Melanzana	68 Lampone	49 Tintoretto	66 Glicine
71 Blu Prussia	44 Cina	82 Azzurro Polvere	24 Avio	47 Argilla	41 Cappuccino
35 Avana	29 Caffè	78 Tortora	09 Biscotto	65 Corda	01 Magnolia
50 Lavagna	46 Muschio	81 Grigio Fumè	48 Pioggia	55 Alluminio	42 Ghiaccio
20 Nero	39 Bianco				

Colori indicativi. Per verificare i toni reali consultare campioni.
Colours as indications. In order to check the real shades, refer to samples.

NOBILITATI PER FRONTALI / MELAMINES FOR FRONT PARTS

NOBILITATI PER STRUTTURE / MELAMINES FOR STRUCTURES



N3 Olmo Calce	N4 Olmo Bio	N5 Tundra
N6 Acacia	NG Olmo Scuro	NT Trama Tessuto
NB Bianco	NH Ghiaccio	NF Corda

Colori indicativi. Per verificare i toni reali consultare campioni.
Colours as indications. In order to check the real shades, refer to samples.

FINITURE / Finishes

ALLUMINIO / ALUMINIUM



TUBO TONDO Ø cm 5 / ROUND TUBE Ø 5 cm

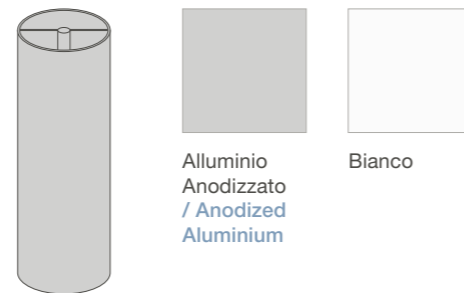

TUBO QUADRO 5 X 5 E 8 X 8 cm / SQUARE TUBE 5 X 5 AND 8 X 8 cm

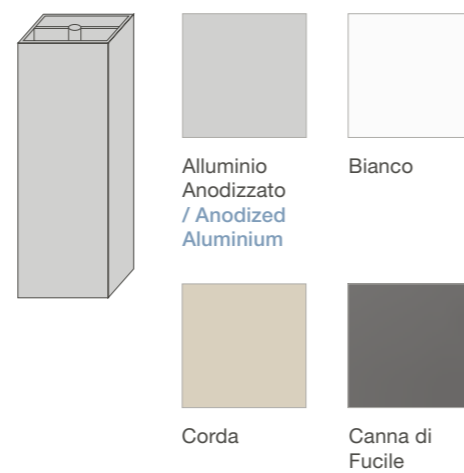

TRAFILA LINEARE / LINEAR PROFILE

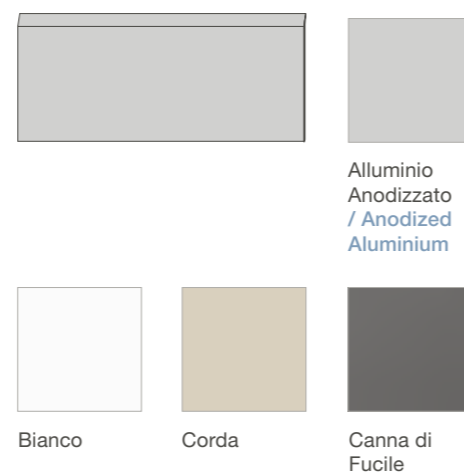

Colori indicativi. Per verificare i toni reali consultare campioni.
Colours as indications. In order to check the real shades, refer to samples.

VETRO SPECCHIATO / MIRRORED GLASS

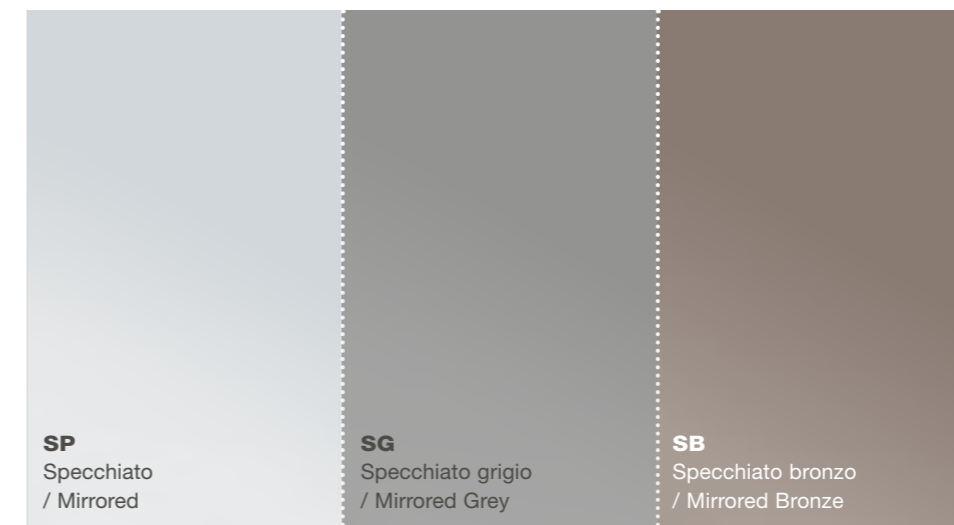

Colori indicativi. Per verificare i toni reali consultare campioni.
Colours as indications. In order to check the real shades, refer to samples.

VETRO EXTRACHIARO RETRO LACCATO / BACK LACQUERED EXTRA-CLEAR

Codici riferimento Laccato Opaco / Reference code Matt Lacquered

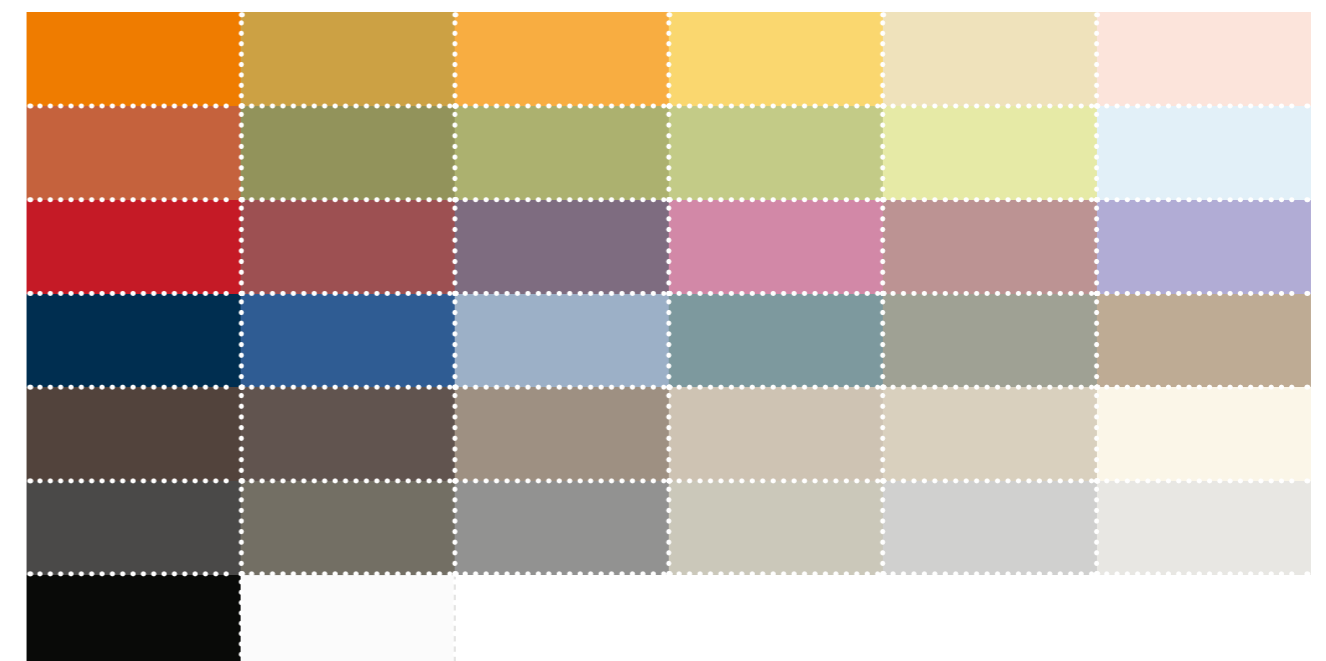

FINITURE / Finishes

PIED DE POULE



FANTASIA / PATTERNED



MILLERIGHE / STRIPES



ECOPELLE / ECOLEATHER



Colori indicativi. Per verificare i toni reali consultare campioni.
Colours as indications. In order to check the real shades, refer to samples.

TESSUTI / FABRICS

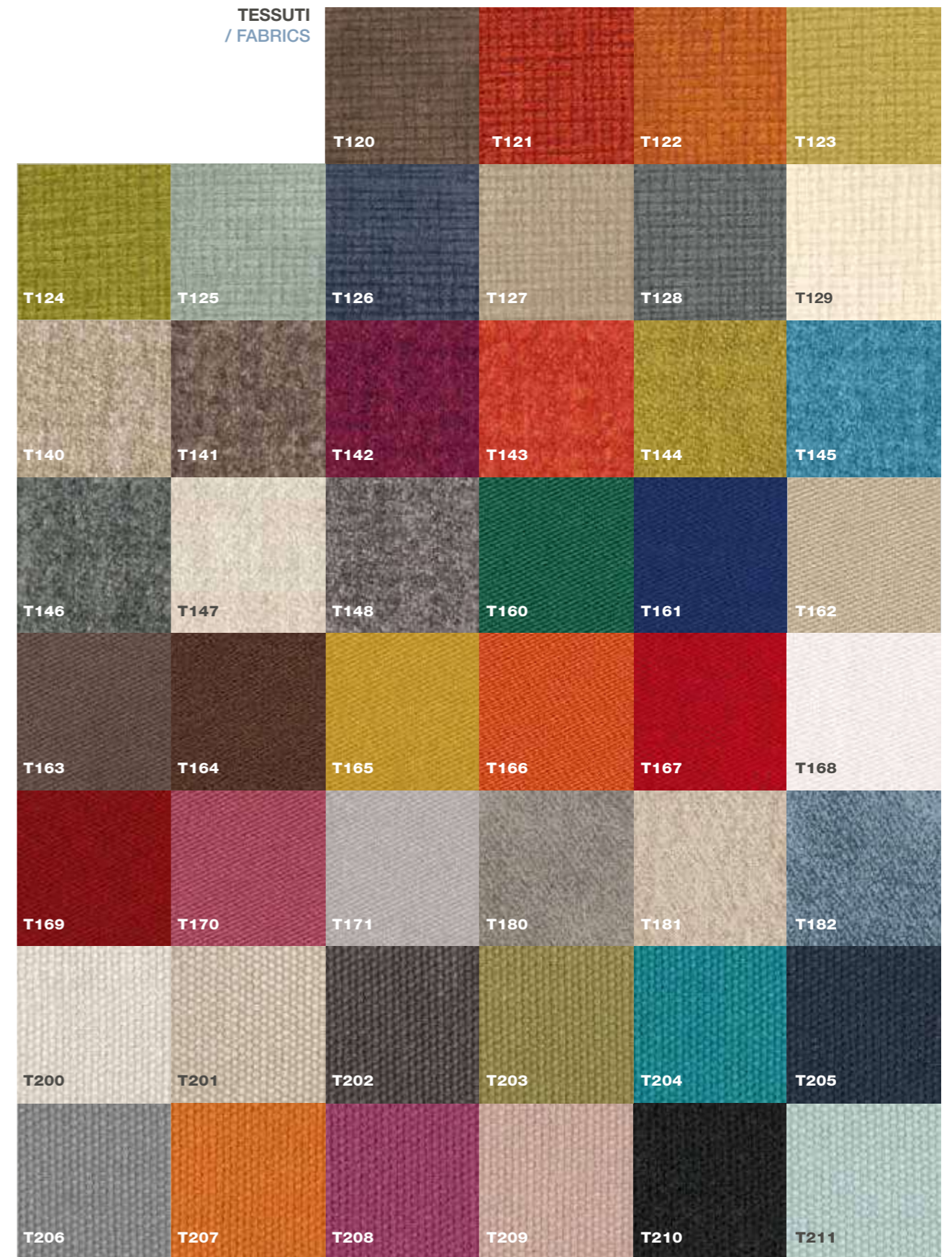

SOPPALCHI CON TRAFILA

Mezzanines with profiles



CONFIGURATION 301 pag. 29



CONFIGURATION 302 pag. 39



CONFIGURATION 315 pag. 129



CONFIGURATION 316 pag. 139



CONFIGURATION 303 pag. 43



CONFIGURATION 304 pag. 49



CONFIGURATION 305 pag. 55

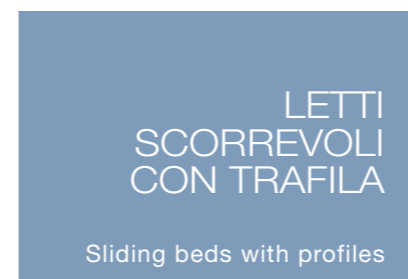

LETTI SCORREVOLI CON TRAFILA

Sliding beds with profiles



CONFIGURATION 317 pag. 149



CONFIGURATION 318 pag. 157



CONFIGURATION 306 pag. 65



CONFIGURATION 307 pag. 69



CONFIGURATION 308 pag. 73



CONFIGURATION 319 pag. 163



CONFIGURATION 320 pag. 171



CONFIGURATION 321 pag. 181



CONFIGURATION 309 pag. 85



CONFIGURATION 310 pag. 91



CONFIGURATION 311 pag. 97



CONFIGURATION 322 pag. 187



CONFIGURATION 323 pag. 193



CONFIGURATION 324 pag. 201



CONFIGURATION 312 pag. 103



CONFIGURATION 313 pag. 115



CONFIGURATION 314 pag. 121



CONFIGURATION 325 pag. 207



CONFIGURATION 326 pag. 213

LETTI
SCORREVOLI
Sliding Beds



CONFIGURATION 327 pag. 219



CONFIGURATION 328 pag. 227



CONFIGURATION 339 pag. 305

EASY
"Easy" System



CONFIGURATION 340 pag. 313

PONTI CON
TRAFILA
Bridges with profiles



CONFIGURATION 329 pag. 237



CONFIGURATION 330 pag. 245



CONFIGURATION 341 pag. 321



CONFIGURATION 342 pag. 327



CONFIGURATION 343 pag. 335



CONFIGURATION 331 pag. 253



CONFIGURATION 332 pag. 257



CONFIGURATION 333 pag. 263



CONFIGURATION 344 pag. 339



CONFIGURATION 345 pag. 349



CONFIGURATION 346 pag. 355



CONFIGURATION 334 pag. 271

PONTI CON
TERMINALE
Bridges with end unit



CONFIGURATION 335 pag. 279



CONFIGURATION 347 pag. 359



CONFIGURATION 348 pag. 365



CONFIGURATION 349 pag. 373



CONFIGURATION 336 pag. 287



CONFIGURATION 337 pag. 291



CONFIGURATION 338 pag. 297



CONFIGURATION 350 pag. 377



CONFIGURATION 351 pag. 385



CONFIGURATION 352 pag. 391

PONTI A SBALZO
Overhang bridges



CONFIGURATION 353 pag. 397



CONFIGURATION 354 pag. 405



CONFIGURATION 366 pag. 489



CONFIGURATION 367 pag. 497



CONFIGURATION 355 pag. 411



CONFIGURATION 356 pag. 421



CONFIGURATION 357 pag. 427

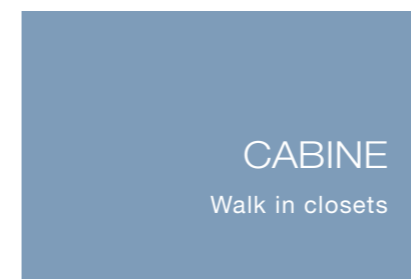

CONFIGURATION 368 pag. 505



CONFIGURATION 369 pag. 513

LETTI A RIBALTA
Foldaway beds



CONFIGURATION 358 pag. 437



CONFIGURATION 359 pag. 443



CONFIGURATION 370 pag. 521



CONFIGURATION 371 pag. 529



CONFIGURATION 360 pag. 449



CONFIGURATION 361 pag. 457



CONFIGURATION 362 pag. 463



CONFIGURATION 363 pag. 469



CONFIGURATION 364 pag. 477



CONFIGURATION 365 pag. 483

Art Direction

Paola Citterio

Concept

Michela Boglietti

Graphic design

Studioopera

Rendering

Marco Rossetti

Set designer

Paola Citterio

Photo

Marco Anconelli

Riccardo Bianchi

Puntozero

Colour separation

CD Cromo

Print

Modulgrafica

Printed in Italy 7.2017

© 2017, TUMIDEI S.r.l

Tutti i diritti riservati.
Nessuna parte del presente catalogo
può essere riprodotta o diffusa
con un mezzo qualsiasi, fotocopie,
microfilm o altro, senza il permesso
del titolare del copyright.

All rights reserved.
No part of this catalogue may be
reproduced or transmitted in any way,
by photocopying, microfilm or else,
without permission of the copyright holder.

Le tonalità dei colori rappresentati nel
Wallimage e nel Doorimage, non potranno mai
essere riprodotte fedelmente, sia in relazione
al nostro campionario laccati, che alle
immagini presenti nei nostri cataloghi.

The shade of the colours shown in Wallimage
and Doorimage cannot be faithfully
reproduced, with regard to our lacquered
samples and to the images which are present
in our catalogues.

t

TUMIDEI

S. Cassiano in Pennino 57/A - 47016 Predappio (FC) Italy

T. +39 0543.921.076

info_italia@tumidei.it - export@tumidei.it - www.tumidei.it



